

FECN Performance for Multistage Output Generated Hotspot Configuration

Jinjing Jiang, Raj Jain, and Chakchai So-In
Washington University in Saint Louis
Saint Louis, MO 63130
Jain@cse.wustl.edu

IEEE 802.1au Meeting, San Francisco July 18th, 2007

These slides are also available at:

<http://www.cse.wustl.edu/~jain/ieee/fecn707a.htm>



- ❑ Multistage Hot-Spot, Fast Start
- ❑ BCN
- ❑ FECN

FECN Overview

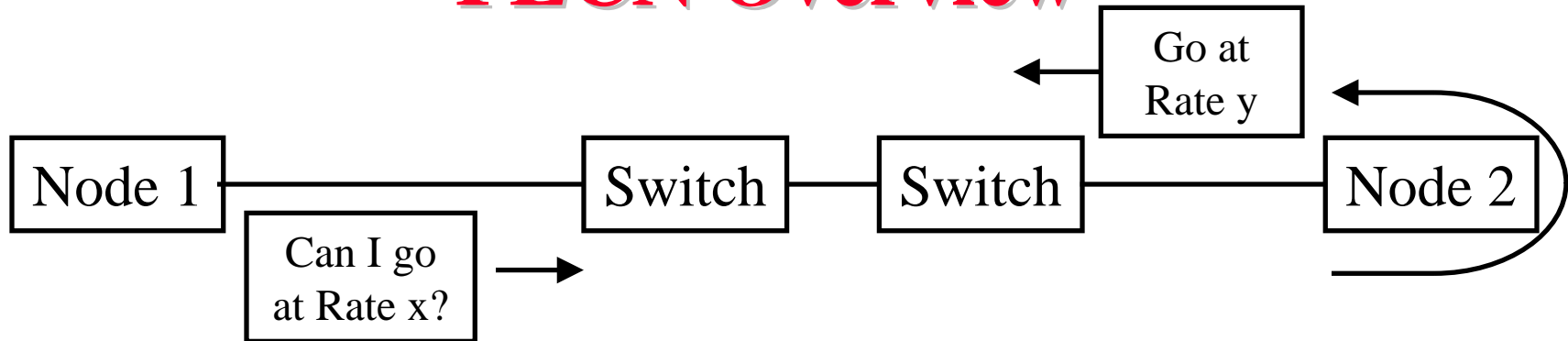

- ❑ Periodically, the sources probe the network for best available rate using “Rate Discovery packet”
- ❑ The probe contain only rate, Rate limiting Q ID
- ❑ The sender initializes the probes with $\text{rate} = -1$ ($\Rightarrow \infty$)
- ❑ Each switch computes an “advertised rate” based on its load
- ❑ The switches adjust the rate in probe packets down if necessary
- ❑ The receiver reflects the RD packets back to the source
- ❑ Source send at the rate received

Simulation Results(Multi-Stage Hotspot)

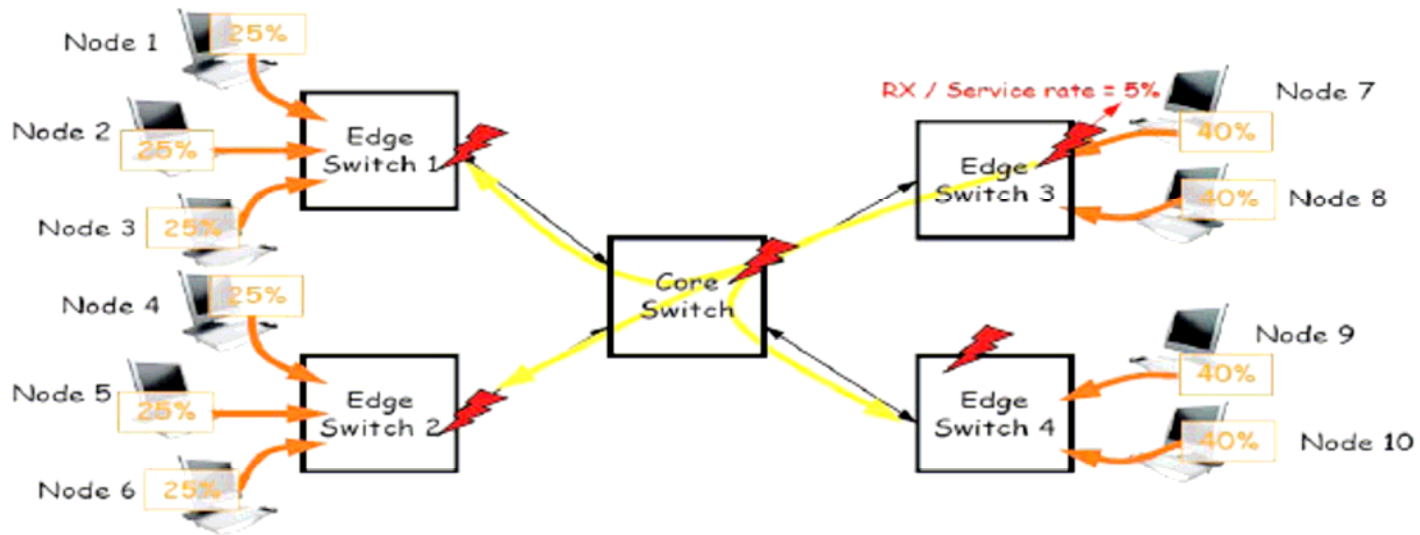

- Multi-stage Output-Generated Hotspot Scenario
 - Link Speed = 10Gbps for all links
 - Loop Latency = 8us
- Traffic Pattern
 - 100% UDP (or Raw Ethernet) Traffic
 - Destination Distribution: Uniform distribution to all nodes (except self)
 - Frame Size Distribution: Fixed length (1500bytes) frames
 - Offered Load
 - Nodes 1-6 = 25% (2.5Gbps)
 - Nodes 7-10 = 40% (4Gbps)

BCN + BCNmax+ 2Qeq + HSSS

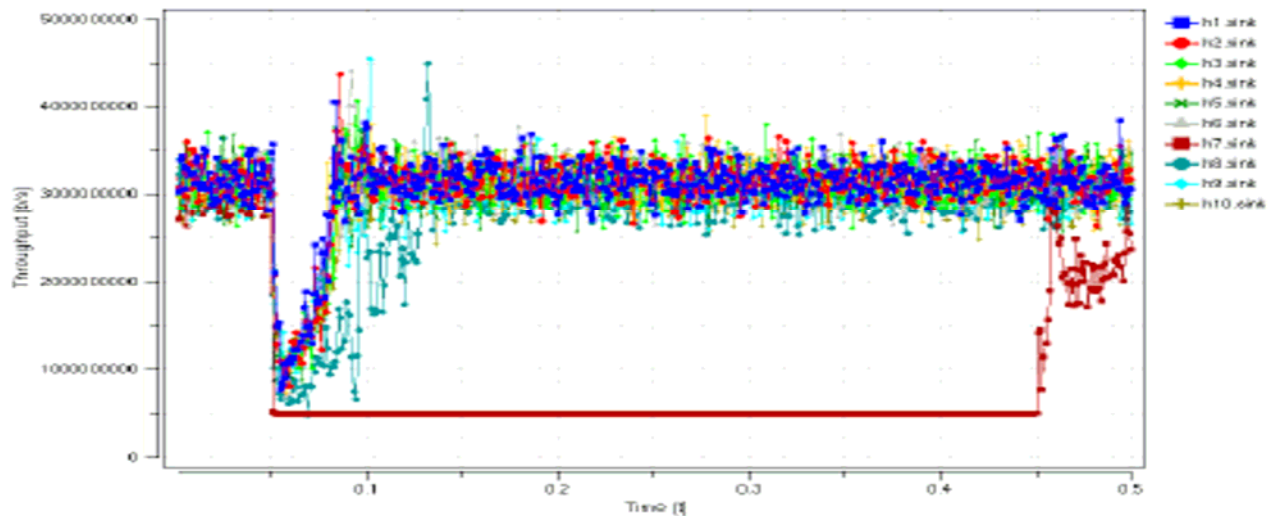
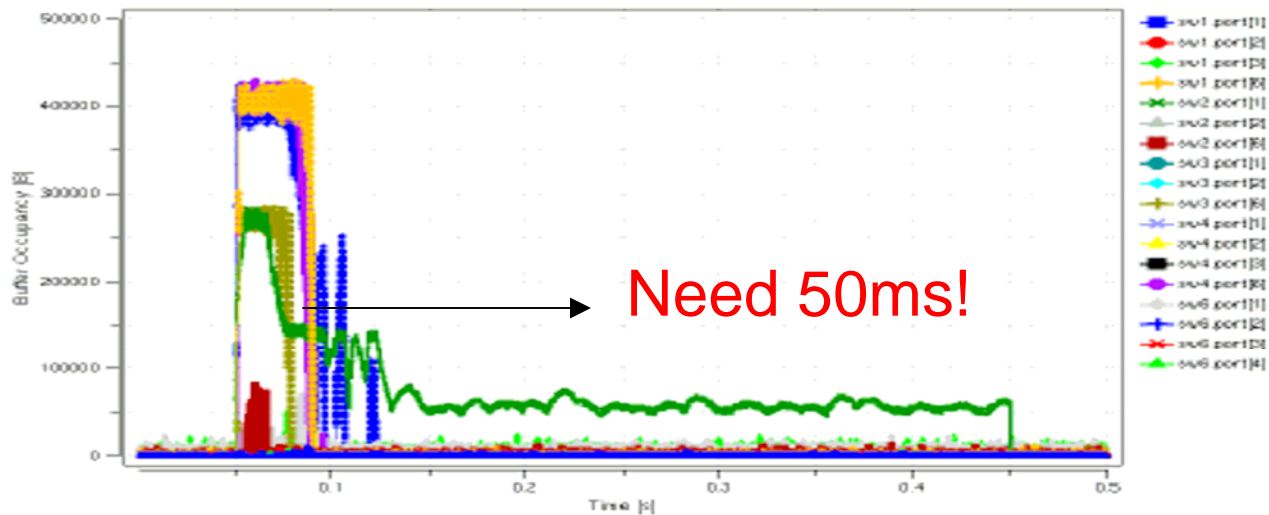

Up to
300ms
in other
versions

Ref: au-sim-bergamasco-multihop-output-generated-010407v1

FECN Queue Lengths (T=1ms)

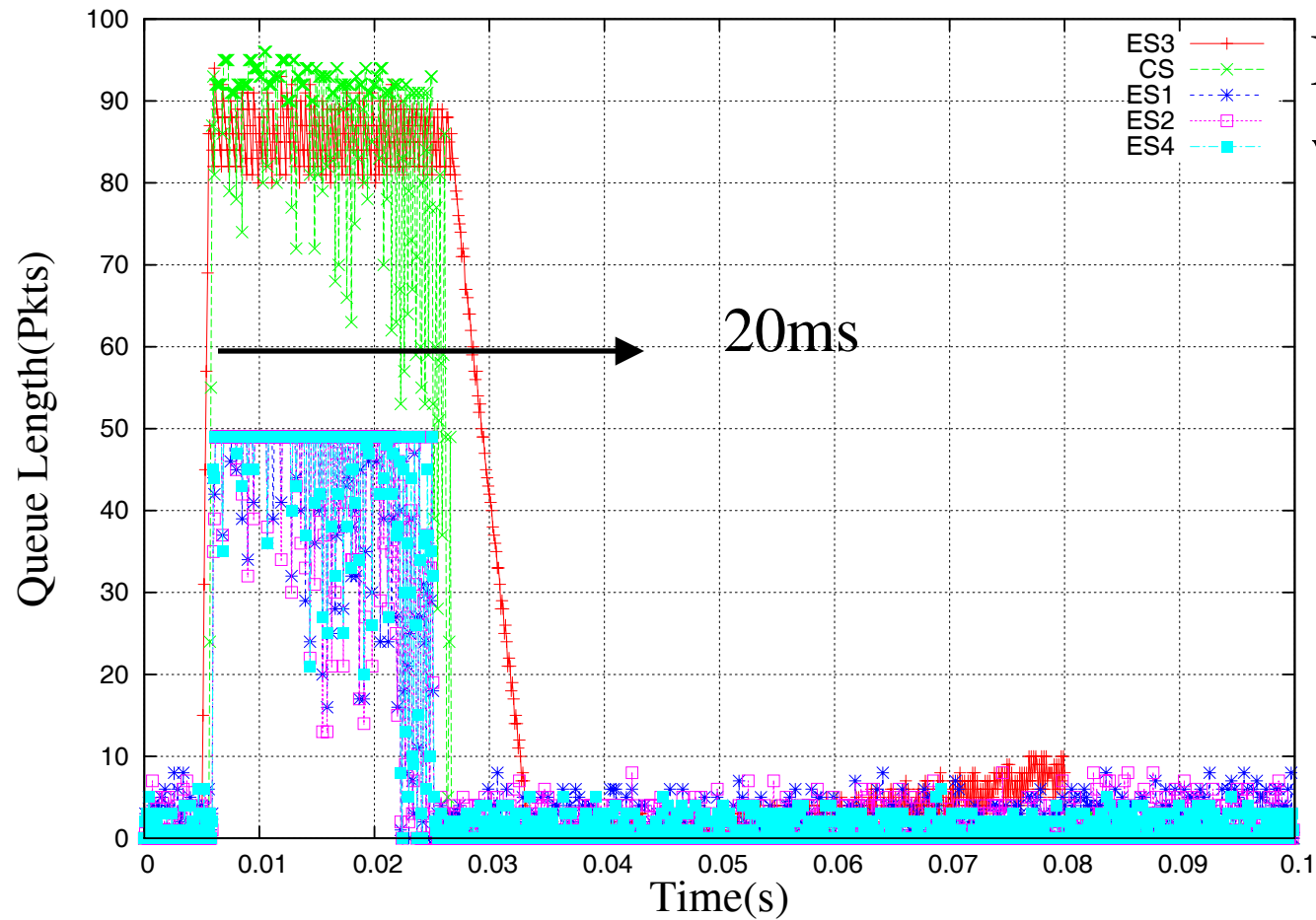

Fast start
with Pause

- FECN's transient response is 2.5 times faster
=> Higher overall throughput.

FECN Link Throughputs (T=1ms)

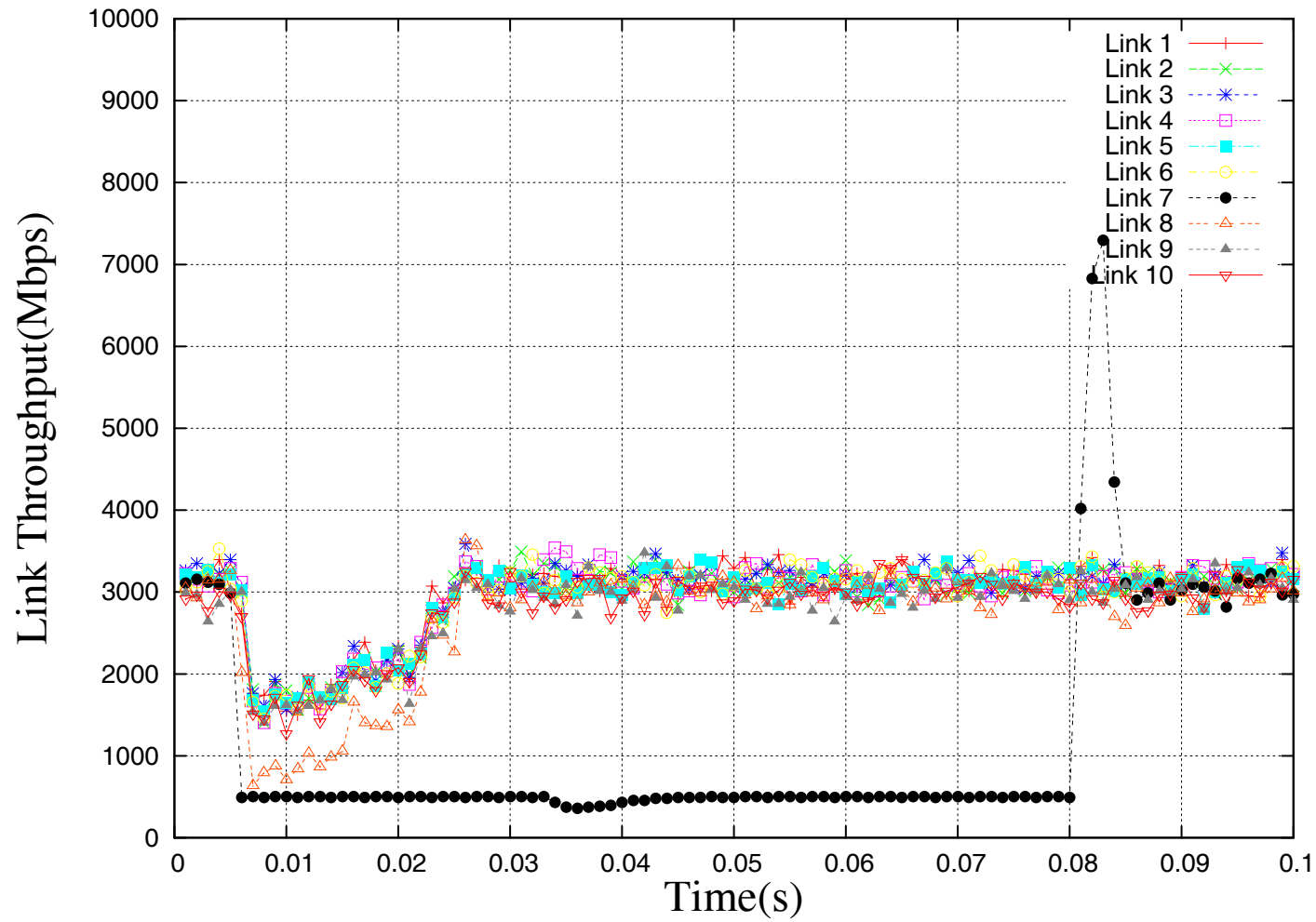

FECN Queue Lengths (T=0.25ms)

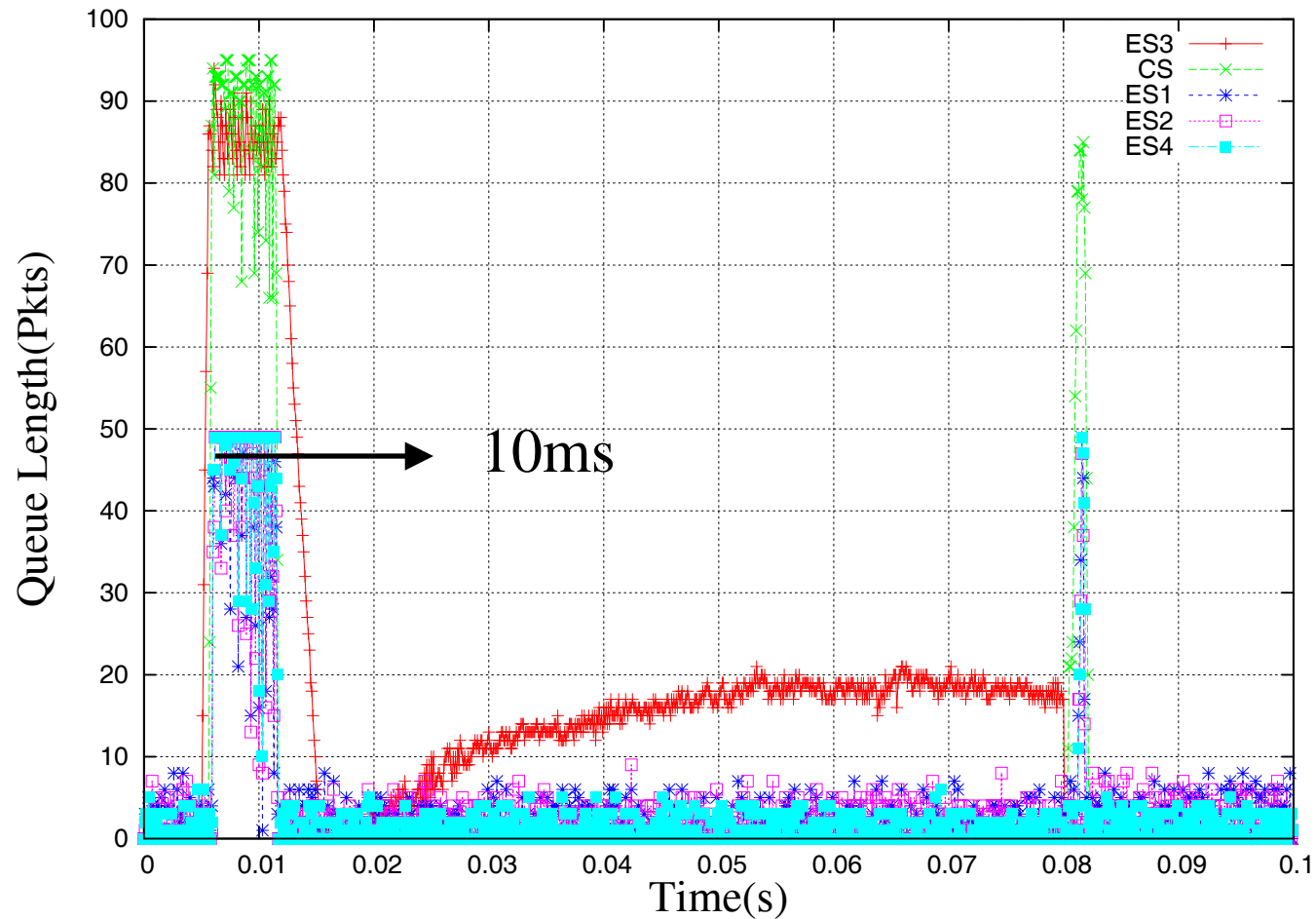

□ Conclusion: FECN's transient response is 5 times faster than BCN => Higher throughput

FECN Link Throughput (T=0.25ms)

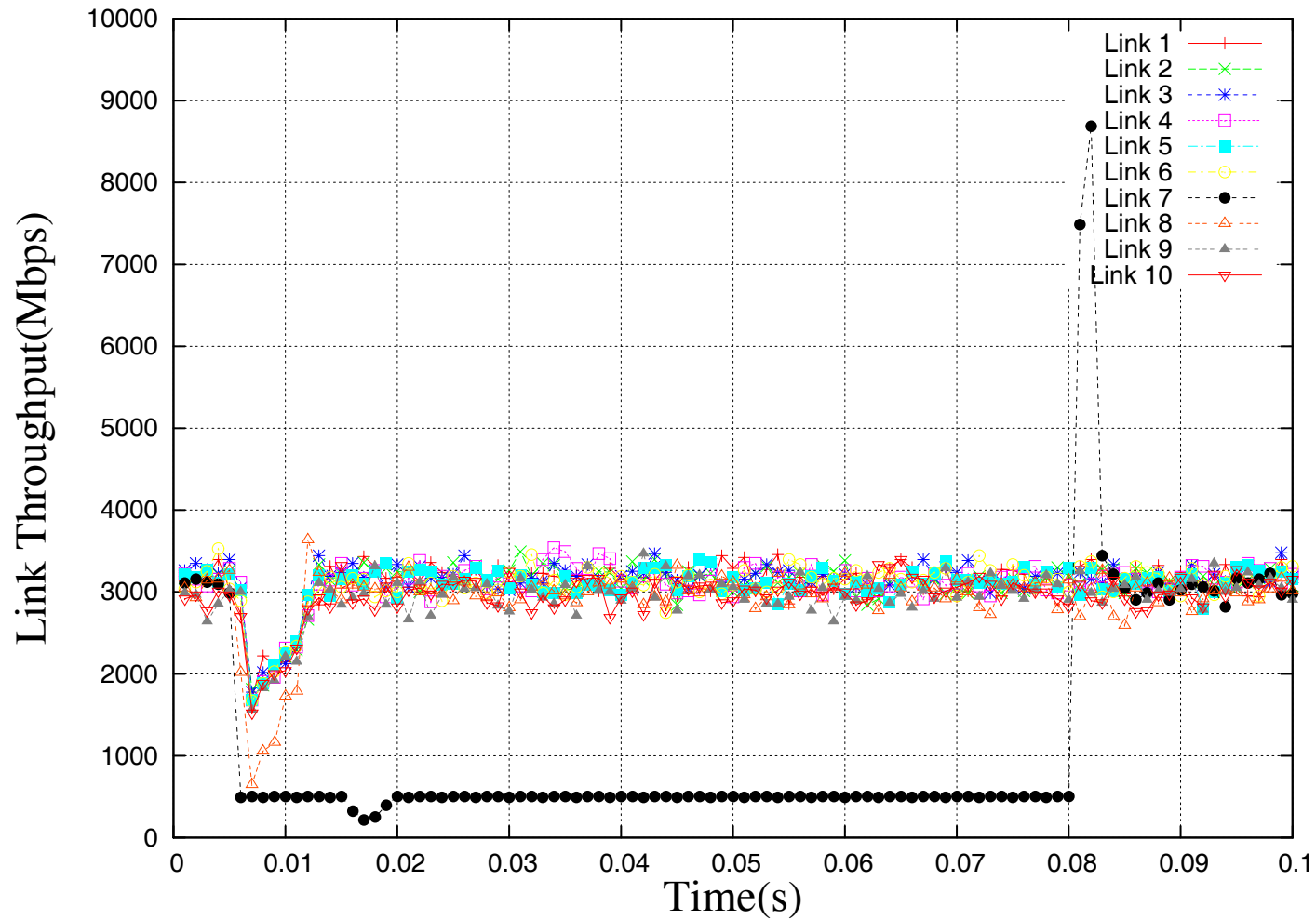

Summary

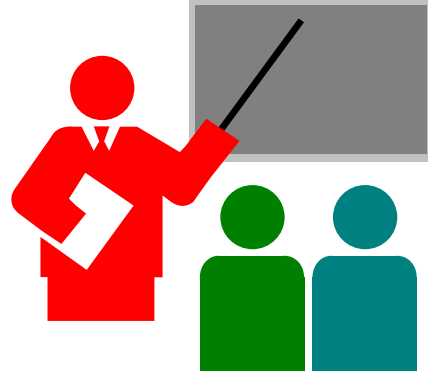

1. FECN by itself works well even with Fast start
2. FECN is 2.5 faster than BCN in multi-stage hot-spot cases
3. FECN has ten times lower overhead than BCN with 10% sampling
4. FECN can be made even faster by decreasing the sampling interval