

Wireless Protocols for IoT Part II: IEEE 802.15.4 Wireless Personal Area Networks and UWB

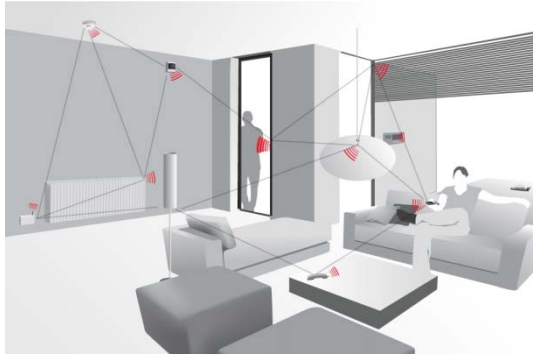

Raj Jain
Washington University in Saint Louis
Saint Louis, MO 63130
Jain@cse.wustl.edu

These slides and audio/video recordings of this class lecture are at:
<http://www.cse.wustl.edu/~jain/cse574-24/>

Student Questions



1. Internet of Things and Wireless Protocols for IoT
2. IEEE 802.15.4: Topologies, MAC, PHY
3. New PHY concepts: Offset-QPSK, Parallel Sequence Spread Spectrum, Chirp Spread Spectrum, Ultra-Wideband
4. IEEE 802.15.4e Enhancements

Note: This is the 3rd lecture in a series of class lectures on IoT. Bluetooth and Bluetooth Smart are also used in IoT and were covered in the previous lectures. Future lectures will cover ZigBee and other protocols.

Student Questions

Wireless Personal Area Networks (WPANs)

- 10m or less

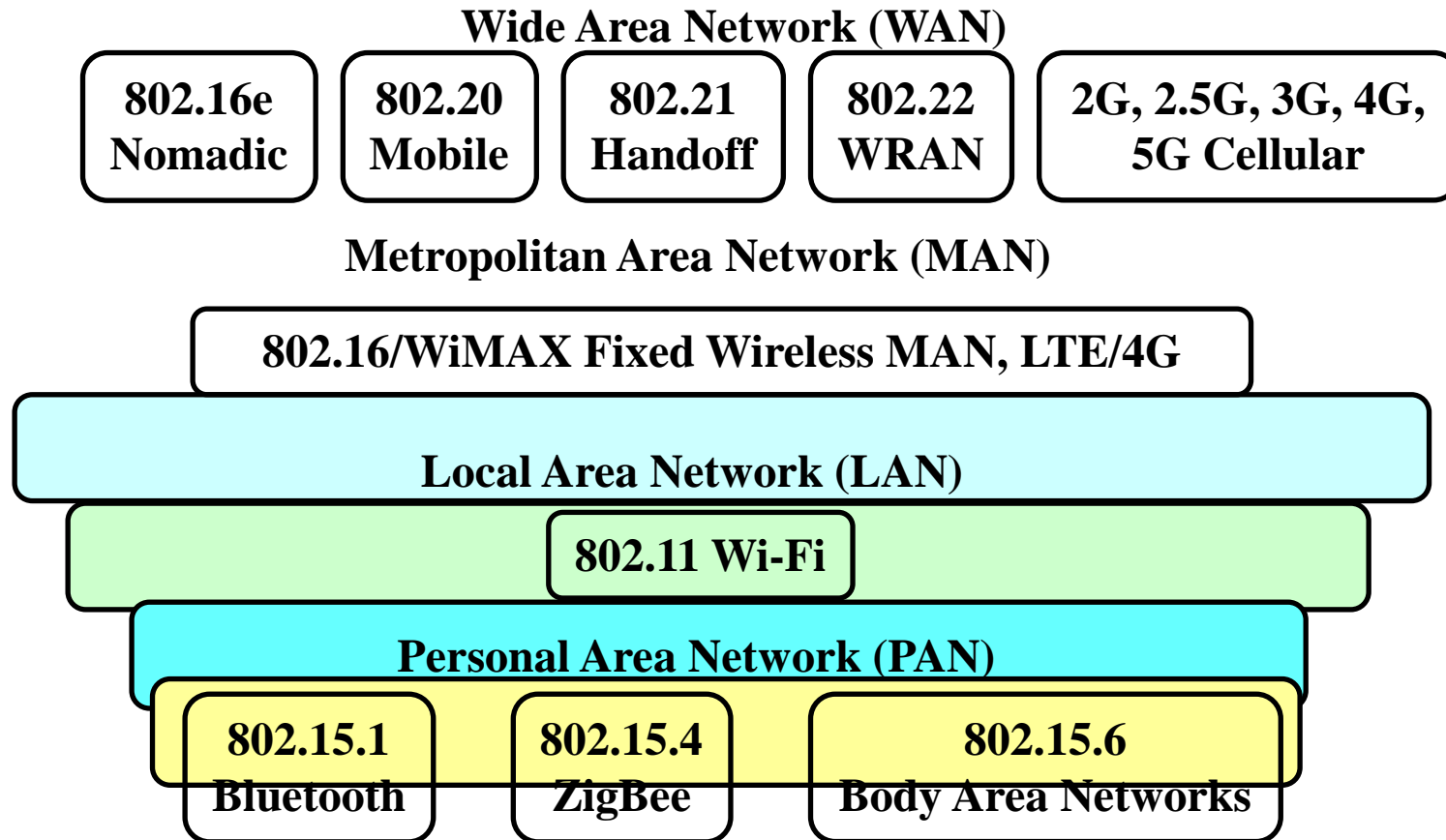

Student Questions

WPAN: Design Challenges

- ❑ **Battery powered:** Maximize battery life.
A few hours to a few years on a coin cell.
- ❑ **Dynamic topologies:** Short-duration connections, and then the device is turned off or goes to sleep
- ❑ **No infrastructure**
- ❑ **Avoid Interference** due to larger powered LAN devices
- ❑ **Simple and Extreme Interoperability:** Billions of devices.
More variety than LAN or MAN
- ❑ **Low-cost:** A few dollars



Student Questions

IEEE 802.15 Projects

- ❑ [IEEE 802.15.1-2005](#): **Bluetooth** 1.2
- ❑ IEEE 802.15.2-2003: Coexistence Recommended Practice
- ❑ IEEE 802.15.3-2016: High Rate (55 Mbps) Multimedia WPAN, includes 3c-2009 mm wave PHY, 3b-2005 High rate WPAN
- ❑ IEEE 802.15.3d-2017: 100 Gbps point-to-point PHY
- ❑ IEEE 802.15.3e-2017: High-Rate close proximity point-to-point MAC and PHY
- ❑ IEEE 802.15.3f-2017: High-rate wireless multi-media networks using mm waves
- ❑ IEEE 802.15.4a-2007: Precision Ranging
- ❑ IEEE 802.15.4c-2009: Chinese 314-316, 430-434, 779-787 MHz
- ❑ IEEE 802.15.4d-2009: Japanese 950 MHz
- ❑ IEEE 802.15.4e-2012: MAC Enhancements
- ❑ IEEE 802.15.4f-2012: PHY for **Active RFID**

Student Questions

- ❑ Is this list still up to date? (in the video it says as of 2018)

See new slide 12-34.

IEEE 802.15 Projects (Cont)

- ❑ IEEE 802.15.4g-2012: PHY for Smart Utility Networks
- ❑ IEEE 802.15.4j-2013: Medical **Body Area Network** 2.36-2.4 GHz
- ❑ IEEE 802.15.4k-2013: Low Energy Critical Infrastructure Monitoring PHY
- ❑ IEEE 802.15.4m-2014: TV **White Spaces** PHY – between 56 MHz and 862 MHz
- ❑ IEEE 802.15.4n-2016: China Medical Band PHY
- ❑ IEEE 802.15.4p-2014: Rail (Train) Communications & Control PHY
- ❑ **IEEE 802.15.4-2015**: Low Rate (250kbps) WPAN – **ZigBee**
- ❑ IEEE 802.15.4md: Maintenance of IEEE 802.15.4-2015
- ❑ IEEE 802.15.4q-2016: Ultra Low Power PHY
- ❑ IEEE 802.15.4s-2018: System resource management capability
- ❑ IEEE 802.15.4t-2017: High rate (2 Mbps) PHY

Student Questions

- ❑ Can 802.15 and 802.11 (or any other wireless technology) interfere with each other? Especially in the case where one device supports multiple wireless technology?

Yes, they interfere. However, if a single device implements multiple protocols, then it has internal mechanisms to avoid interfering. There are some mechanisms to avoid external interference. Mostly by retransmissions.

- ❑ Can integrating cognitive radio-like technologies to adjust frequencies minimize interference.

Cognitive techniques do not work if the primary is frequency hopping.

IEEE 802.15 Projects (Cont)

- ❑ IEEE 802.15.4u-2016: 865-867 MHz band in India
- ❑ IEEE 802.15.4v-2017: Enabling use of regional sub-GHz bands (4n, 4q, 4t, 4u)
- ❑ IEEE P802.15.4w: Low-Rate Low-Power Wide Area Network (**LPWAN**) extension to 802.15.4 PHY to cover 10-15 km
- ❑ IEEE P802.15.4x: Field Area Network extensions for devices with no battery or very limited battery consumption (Smart Utility Network)
- ❑ IEEE P802.15.4y: Security next generation using AES-256
- ❑ IEEE P802.15.4z: Enhanced impulse radio **Ultra-Wide Band** (UWB)
- ❑ IEEE 802.15.5-2009: Mesh Networking. Full/partial meshes. Range Extension
- ❑ IEEE 802.15.6-2012: Body Area Networking. Medical and entertainment. Low power
- ❑ IEEE 802.15.7-2011: Short-Range **Optical Wireless**

Student Questions

IEEE 802.15 Projects (Cont)

- ❑ IEEE P802.15.7r1: Optical wireless (infrared, ultraviolet, visible light)
- ❑ IEEE P802.15.7m: Maintenance of 802.15.7-2011
- ❑ IEEE 802.15.8-2017: Peer Aware Communications
- ❑ IEEE 802.15.9-2016: Key Management Support
- ❑ IEEE 802.15.10-2017: Routing packets in dynamically changing wireless networks
- ❑ IEEE P802.15.10a: Routing mode additions. Automated discovery of nodes and route configuration
- ❑ IEEE P802.15.12: Upper Layer Interface (ULI) to harmonize fragmentation, configuration, etc. for all 802.15.4 (Upper L2 and interface to L3)
- ❑ IEEE P802.15.13: **Multi-Gigabit/s Optical Wireless** with ranges up to 200m
- ❑ IEEE 802.15 IG6T: Consolidate Link Layer Control interest group
- ❑ IEEE 802.15 IGdep: Enhanced Dependability interest group
- ❑ IEEE 802.15 IGvat: **Vehicular** Assistive Technology

Student Questions

- ❑ Some IEEE standards have a P as a prefix, like P802.15.13. What does the P prefix signify?

P=Project ⇒ Under development

- ❑ Could you explain what IG (Interest Group) is again? What is the difference between it and the normal group?

Most groups start with a tutorial. Then they become an interest group and write a proposal. Then if approved, they become a working group.

IEEE 802.15 Projects (Cont)

- ❑ IEEE 802.15 IGguide: Guide for 15.4 use interest group
- ❑ IEEE 802.15 IGhrrc: High-Rate Rail Communications interest group
- ❑ IEEE 802.15 IGTHz: **Terahertz** interest group
- ❑ IEEE 802.15 SCwng: Wireless Next-Generation standing committee
- ❑ IEEE 802.15 SCmaint: Maintenance standing committee
- ❑ IEEE 802.15 SCietf: IETF Liaison

Student Questions

- ❑ When you say, "TeraHertz is almost like a light," is this because it is such a high frequency?

Yes. See Slide 3-8 on Electromagnetic Spectrum. Light is ≈ 300 THz.

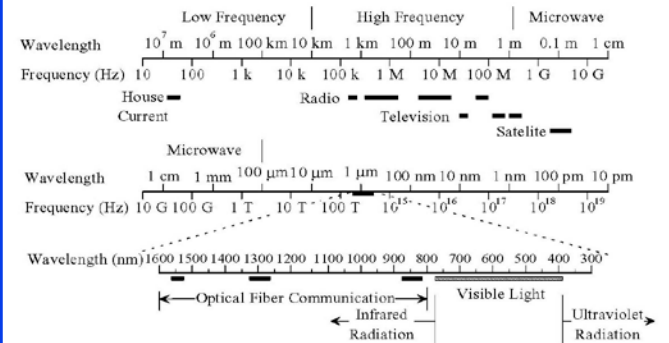

IEEE 802.15.4

- Used by several “Internet of Things” protocols:
ZigBee, 6LoWPAN, Wireless HART, MiWi, and ISA 100.11a

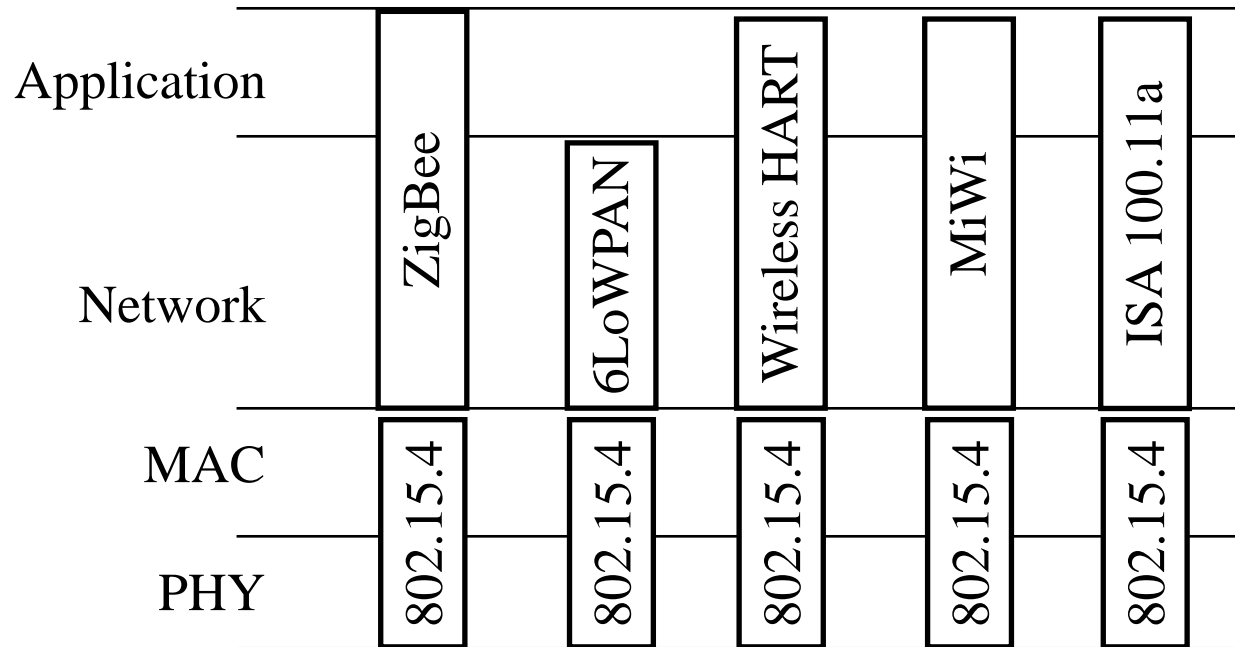

Student Questions

IEEE 802.15.4 Overview

- ❑ Low Rate Wireless Personal Area Network (LR-WPAN)
- ❑ 2.4 GHz (most common). 16 5-MHz channels
- ❑ 250 kbps PHY \Rightarrow 50 kbps application data rate
- ❑ Peak current depends upon symbol rate \Rightarrow multilevel (4b/symbol)
- ❑ Similar to 802.11: Direct Sequence Spread Spectrum, CSMA/CA, Backoff, Beacon, Coordinator (similar to Access point)
- ❑ Lower rate, short distance \Rightarrow Lower power \Rightarrow Low energy
- ❑ Each node has a 64-bit Extended Unique ID (EUI-64):

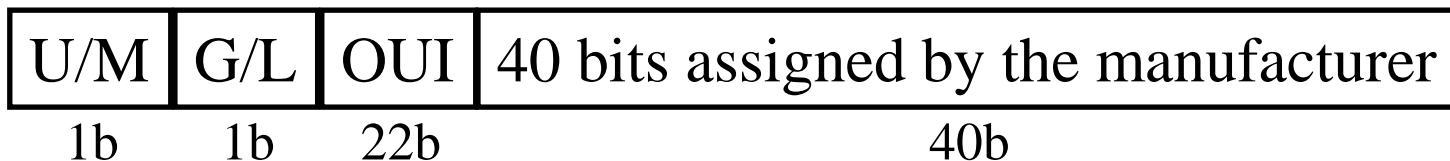

- ❑ No segmentation/reassembly. The Max MAC frame size is 127 bytes with a payload of 77+ bytes.

Student Questions

- ❑ Does the Extended Unique ID function as the MAC address for 802.15.4 devices?

Yes. They do not use the 48-bit IEEE address.

- ❑ If the first bit is one and the second is one does it mean U G?

No.

0/1 0/1

U/M G/L

0 0 Unicast, globally unique

0 1 Unicast, Local

1 0 Multicast, Globally unique

1 1 Multicast, Local

IEEE 802.15.4 Overview

- ❑ Low Rate Wireless Personal Area Network (LR-WPAN)
- ❑ 2.4 GHz (most common). 16 5-MHz channels
- ❑ 250 kbps PHY \Rightarrow 50 kbps application data rate
- ❑ Peak current depends upon symbol rate \Rightarrow multilevel (4b/symbol)
- ❑ Similar to 802.11: Direct Sequence Spread Spectrum, CSMA/CA, Backoff, Beacon, Coordinator (similar to Access point)
- ❑ Lower rate, short distance \Rightarrow Lower power \Rightarrow Low energy
- ❑ Each node has a 64-bit Extended Unique ID (EUI-64):

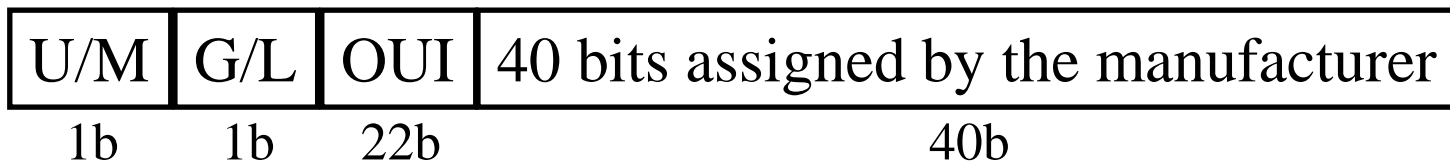

- ❑ No segmentation/reassembly. The Max MAC frame size is 127 bytes with a payload of 77+ bytes.

Student Questions

- ❑ Is it possible that two devices will try to become coordinators? Or is there a method designed to avoid this?

Each coordinator will have its own secondary and, thus, its own groups. Some nodes may join multi-groups and become routers.

- ❑ Does each LR-WPAN node have an EUID and MAC address or just an EUID?

Some devices may have only EUID, some may have only MAC, and some may have both.

IEEE 802.15.4 Topologies

- ❑ Star and peer-to-peer
- ❑ Two types of devices: Full Function device (FFD), Reduced Function device (RFD)

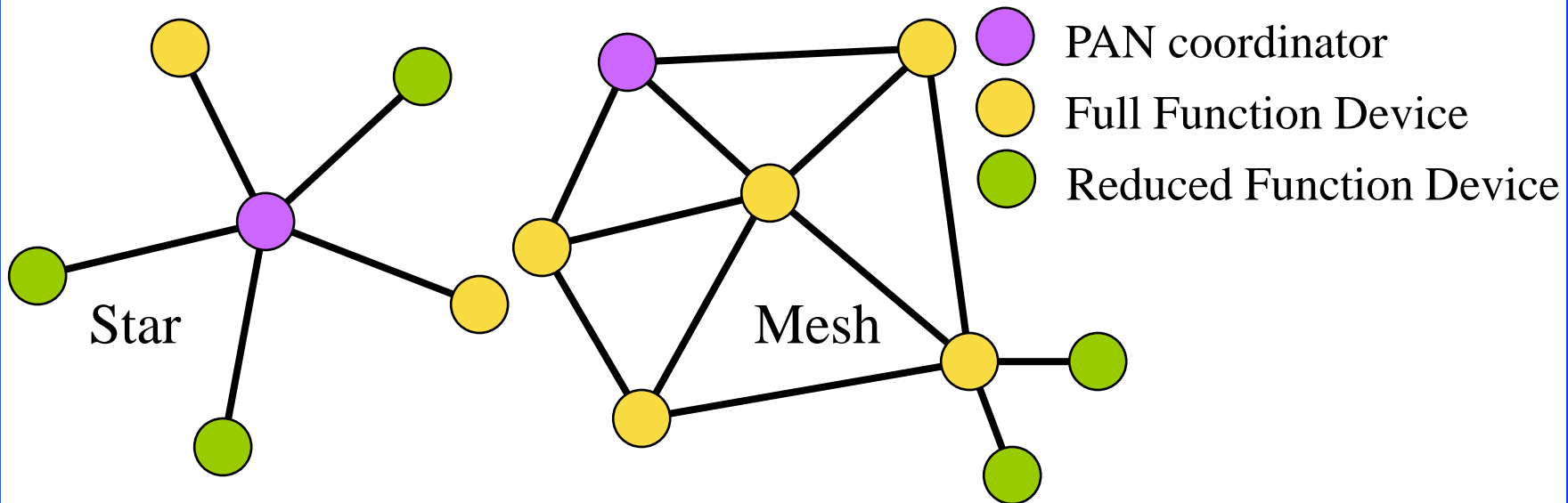

Student Questions

- ❑ If a coordinator is taken offline, does the coordinator duty fall to another FFD or is the piconet disbanded?

If there is another FFD, it will notice that the root has gone away, it will start another network.

- ❑ Is it possible to have more than one coordinator in a single network?

It is called a cluster, as discussed later in slide 12.14.

IEEE 802.15.4 Topologies

- ❑ Star and peer-to-peer
- ❑ Two types of devices: Full Function device (FFD), Reduced Function device (RFD)

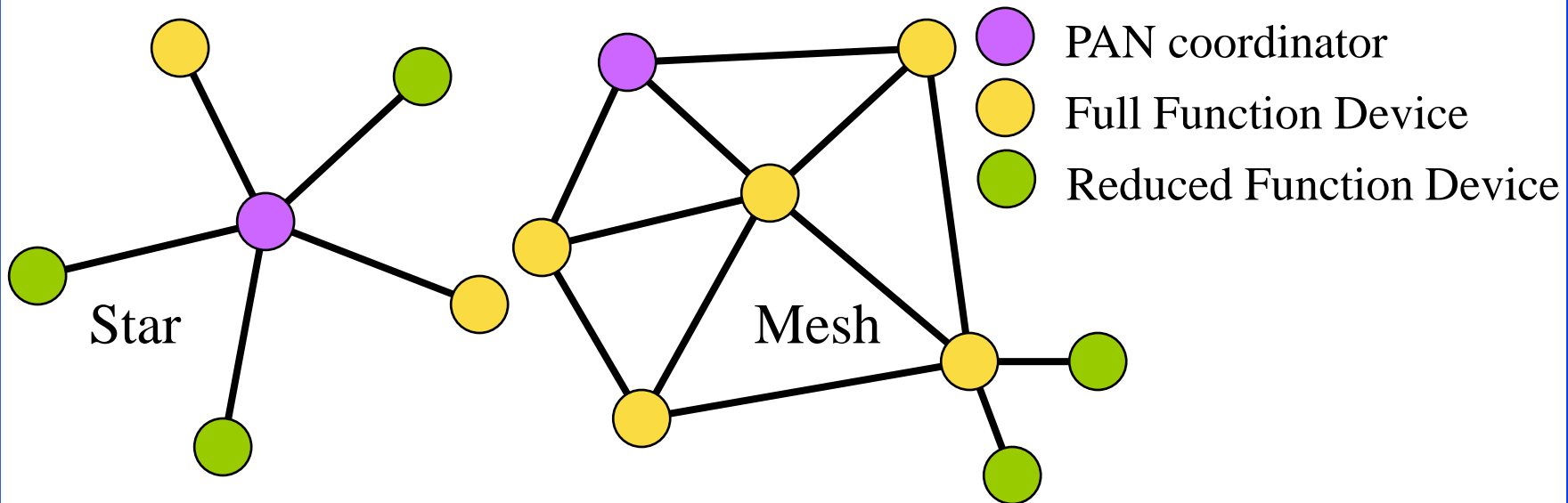

Student Questions

- ❑ How does a device determine whether it is an FFD or RFD?
The manufacturer programs it.
- ❑ Since the network topology is dynamic, how does the network self-heal or reconfigure when a full-function or reduced-function device goes offline?
*If there is no RFD, there is no issue.
If there is no FFD, only star topology is possible.*

Coordinator

- ❑ FFDs can become the coordinator and can also route messages to other nodes
- ❑ RFDs cannot become the coordinator and can only be a leaf
- ❑ FFD that starts a PAN becomes the coordinator
- ❑ In star topology, all communication is to/from the coordinator
- ❑ In P2P topology, FFDs can communicate directly also.
- ❑ Each piconet has a PAN ID and is called a **cluster**.
- ❑ Nodes join a cluster by sending association requests to the coordinator. The coordinator assigns a 16-bit short address to the device. Devices can use either the short address or the EUI-64 address.

Student Questions

- ❑ Why would devices use the EUI address if the 16-bit address is available?

EUI Address is global. 16-bit address is local. Global address can be used everywhere at all times. They are too long to use and so short addresses are used after registration.

- ❑ Are the coordinators set up statically when the network is set up initially, or can the nodes dynamically decide who is going to be the coordinator per each transmission?

The human owner associates the list of device members in the network and who can become the root.

- ❑ If nodes used short addresses only, we have 2^{16} nodes in each cluster.

Yes. $2^{16}-2$. All 1's is broadcast. All 0's is not used.

- ❑ Do Star and Mesh both belong to some kind of cluster?

A cluster can have a star or a mesh topology. A star is a particular case (subset) of mesh.

- ❑ Does P2P also have a PAN ID?
Yes, one of the FFDs becomes a coordinator.

Cluster Tree Network

- A coordinator can ask another FFD to become a coordinator for a subset of nodes. Tree \Rightarrow No loops

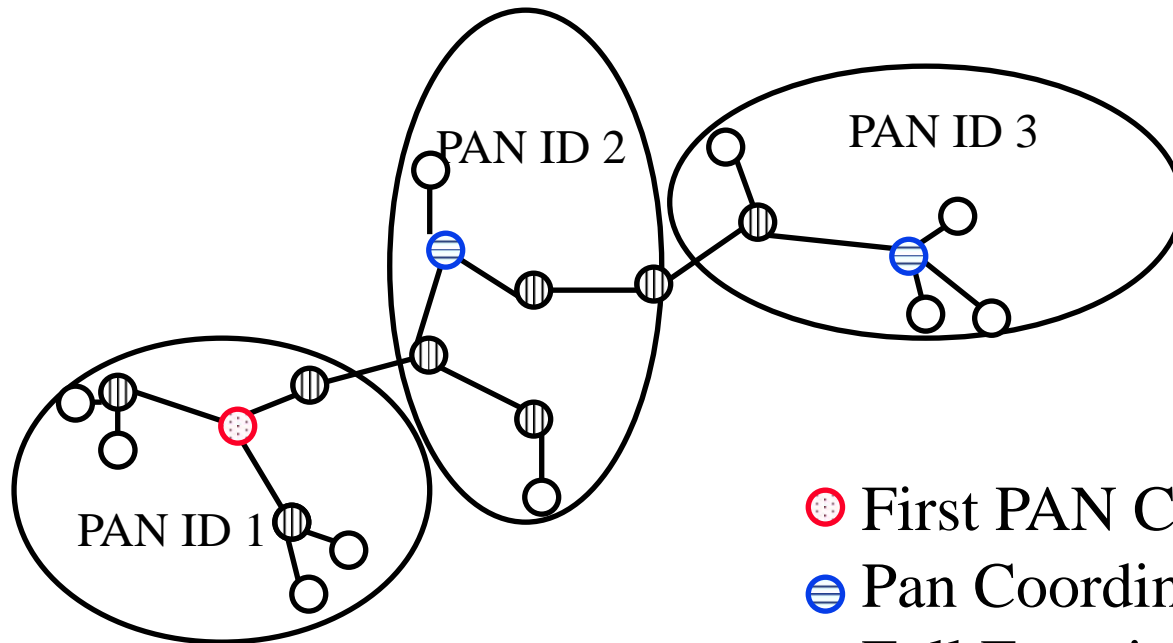

- First PAN Coordinator
- Pan Coordinators
- Full Function Device
- Reduced Function Device

Student Questions

- What exactly is a loop? Is it a cycle?
Yes, when packets start from 1 to go somewhere but come back to 1 on their way. That will never end. This is why IP has hop count limit.
- PAN chooses new PAN coordinators based on what? And does the new coordinator polls addresses within their network?
RPL protocol is used to elect the coordinator. The protocol results in a tree topology.

- If the connection between FFDs in PAN ID 1 and 2 fail in this case, will it try to form new network with other FFD or just stop?

They are always listening to connection requests.

Cluster Tree Network

- A coordinator can ask another FFD to become a coordinator for a subset of nodes. Tree \Rightarrow No loops

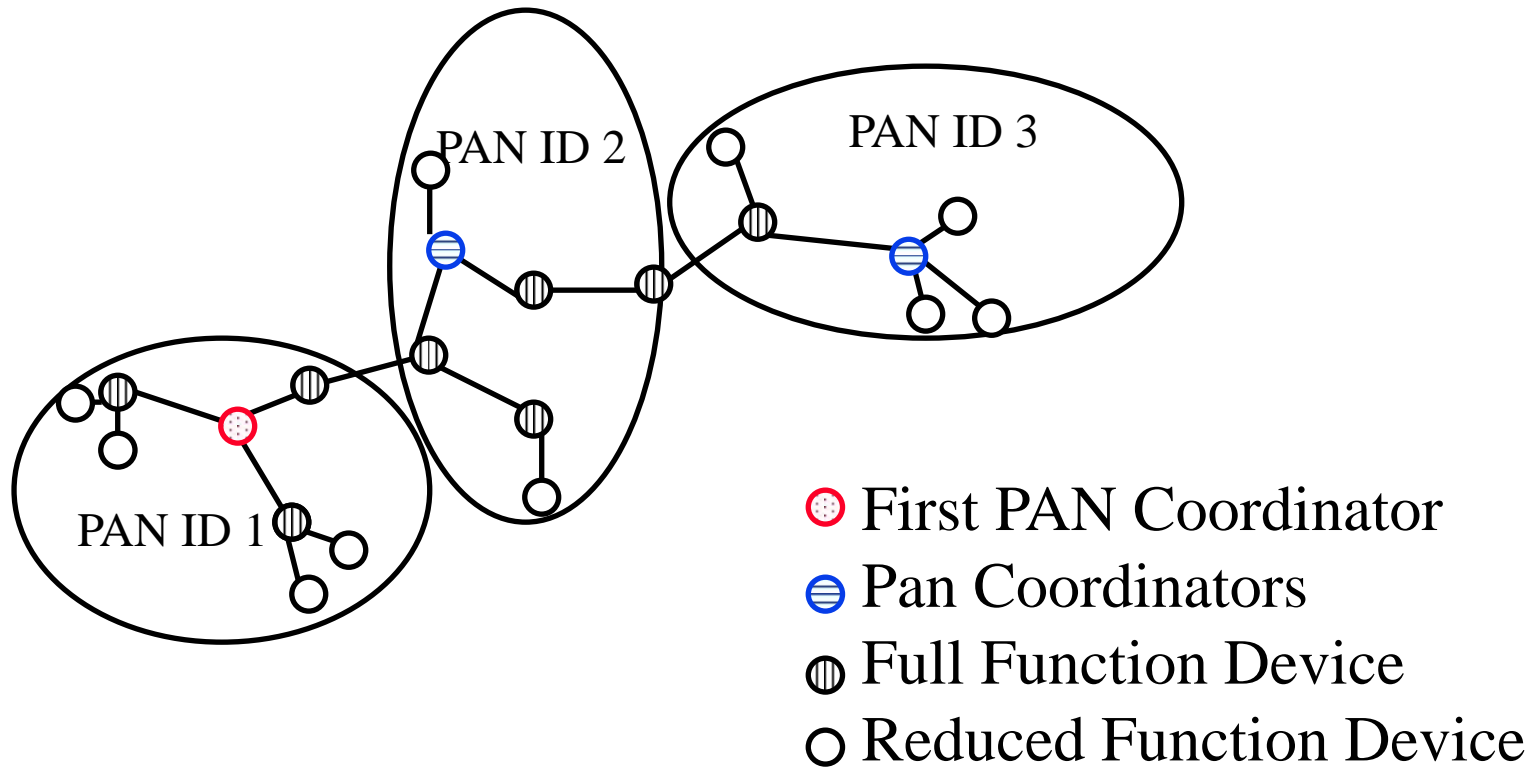

Student Questions

- In a cluster tree, can an individual PAN be Amish as long as it doesn't connect to other PANs? If so, does any routing optimization take place in the cluster tree?
A PAN may be a leaf or a non-leaf, depending on the availability of FFDs. Routing is a complex topic discussed in the next module. Yes, it is optimized.

IEEE 802.15.4 MAC

Beacon-Enabled CSMA/CA

- ❑ Coordinator sends out beacons periodically
- ❑ Part of the beacon interval is inactive \Rightarrow Everyone sleeps
- ❑ Active interval consists of 16 slots
- ❑ Guaranteed Timed Slots (GTS): For real-time services. Periodic reserved slots.
- ❑ Contention Access Period (CAP). Slotted CSMA.

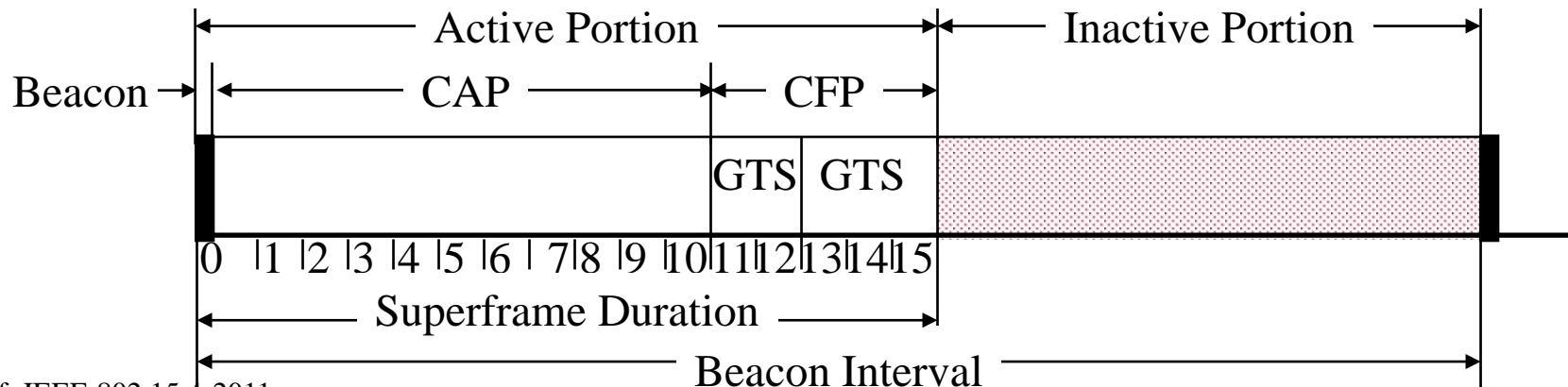

Student Questions

- ❑ How many GTS can CFP have? Min, max
The inactive portion can be zero.
The contention access period can also be zero.
There is no limit to the beacon interval. So the range is infinite.

IEEE 802.15.4 MAC (Cont)

❑ Beaconless Operation: Unslotted CSMA

➤ If the coordinator does not send beacons, there are no slots

❑ Acknowledgements if requested by the sender.

❑ Short inter-frame spacing (SIFS) if the previous transmission is shorter than a specified duration. Otherwise, Long inter-frame spacing (LIFS)

Acknowledged Transmissions

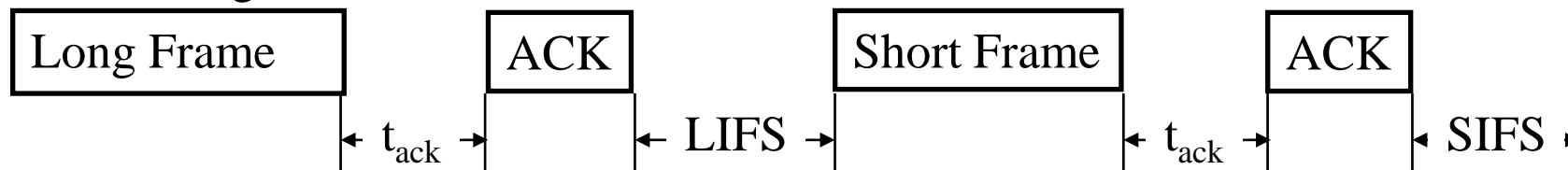

Unacknowledged Transmissions

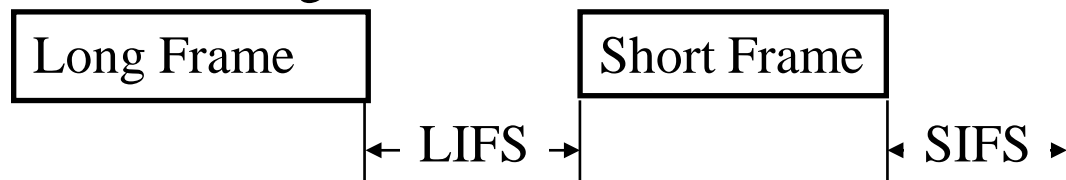

Student Questions

- ❑ In beaconless transmissions, how do we make sure the transmission is sent to the intended receiver? Wouldn't every device on the network receive the message and potentially send wrong acks?

Every packet has a destination address. Only the destination acks.

- ❑ What makes a frame Long or Short? *Acknowledgment, beacon and MAC command frames are short. Data frames are long.*

- ❑ Which mode is the first option to use? Slotted or unslotted?

The network starts unslotted. The coordinator makes it slotted.

- ❑ Compared with Beacon-Enabled CSMA, unslotted CSMA does not have an Inactive Portion. Does that mean it uses more energy?

Unslotted CSMA can have an inactive period during which no one is transmitting.

- ❑ When will Unacknowledged Transmissions be used?

Periodically repeated transmissions

802.15.4 CSMA/CA

- ❑ Wait until the channel is free.
- ❑ Wait for a random back-off period
If the channel is still free, transmit.
- ❑ If the channel is busy, back off again.
Backoff exponent limited to 0-2 in battery life-extension mode.
- ❑ Acknowledgement and Beacons are sent without CSMA-CA.

Student Questions

- ❑ Does this apply to beaconless operation or beacon-enabled?

Both beaconless operation and during the contention period in beacon-enabled operation.

Ultra-Wideband

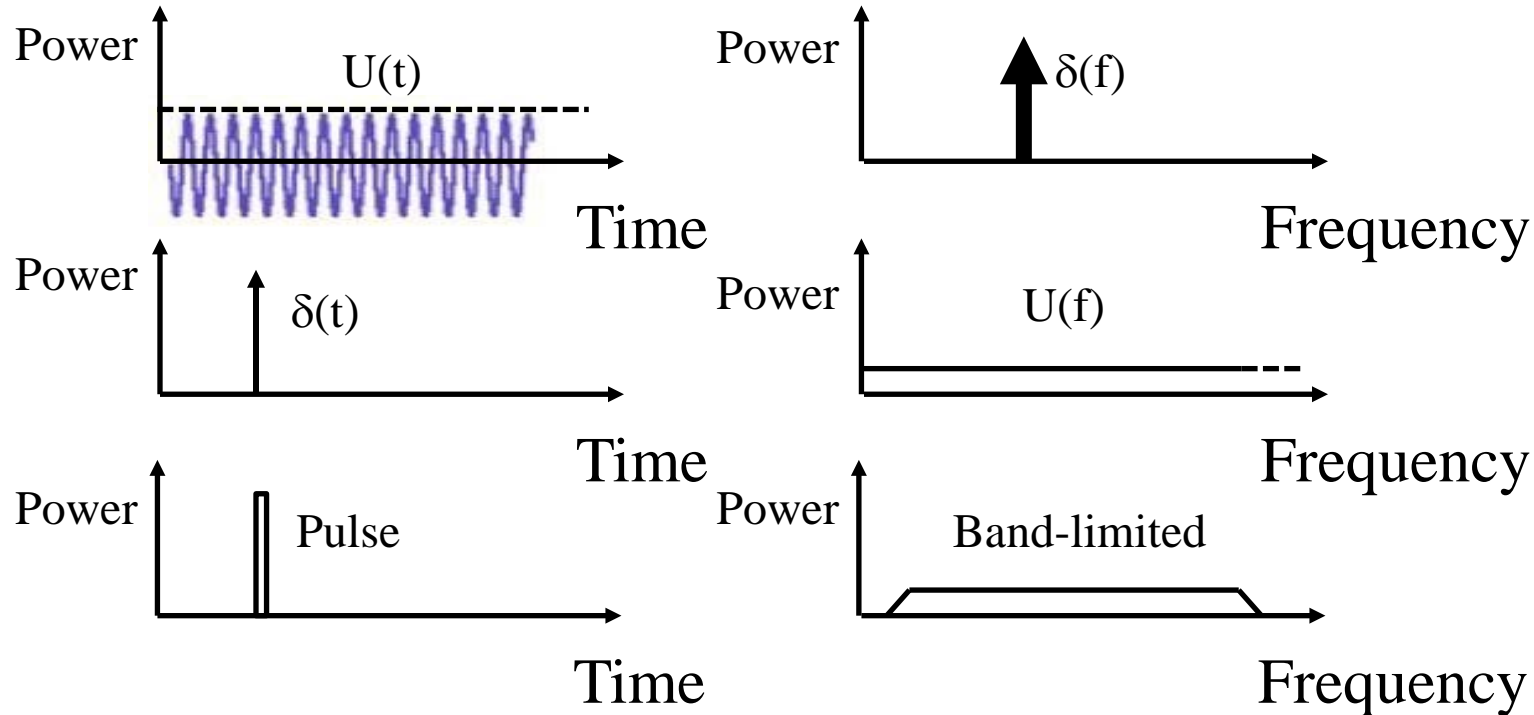

- ❑ An impulse in the time domain results in an ultra-wide spectrum in the frequency domain and essentially looks like white noise to other devices

Student Questions

- ❑ I wonder why the Fourier transform of $\sin(2\pi ft)$ has only one impulse at frequency f . How about $-f$?

All power is at one frequency \Rightarrow Impulse at f . There is no negative frequency. The minimum frequency is zero = Direct Current.

- ❑ Why is the Fourier transform of the delta(t) band limited rather than one throughout all frequencies?

Yes, the Inverse Fourier transform of $\delta(t)$ is $U(f)$. The third row shows the frequency domain of a realistic pulse which has a finite width in time domain and so is band limited in frequency domain.

Ultra-Wideband (UWB)

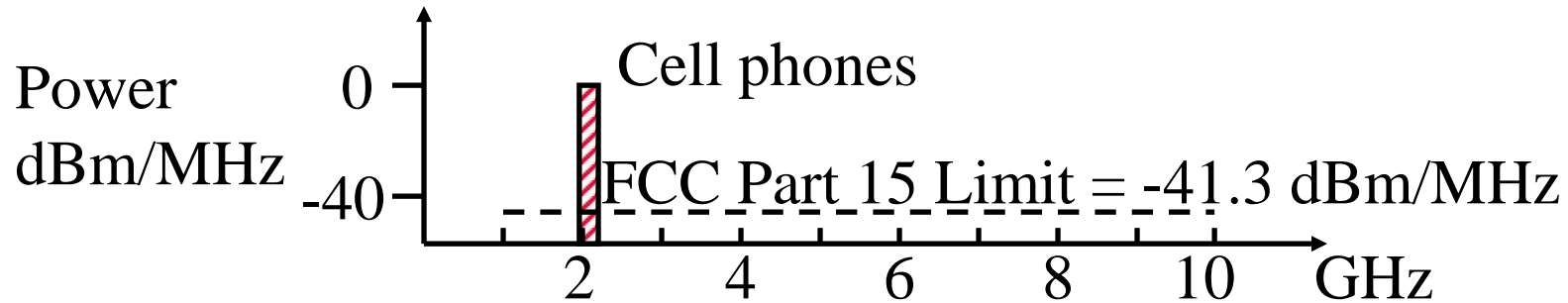

- ❑ FCC rules restrict the maximum noise generated by a wireless equipment (0 dBm = 1mW, -40 dBm = 0.1 μ W)
- ❑ It is possible to generate very short (sub-nano sec) pulses that have a spectrum below the allowed noise level
 \Rightarrow Possible to get Gbps using a 10 GHz spectrum
- ❑ FCC approved UWB operation in 2002
- ❑ UWB can be used for high-speed over short distances
- ❑ UWB can see through trees and underground (radar)
 \Rightarrow collision avoidance sensors, through-wall motion detection
- ❑ Position tracking: cm accuracies. Track high-value assets

Student Questions

- ❑ Given that UWB is below the noise level, how can you determine that communication is happening? Can it work if the noise is high?

Yes, using FFT and IFFT, one can differentiate the signal from the noise.

- ❑ What range of the frequency spectrum is used by the ultra wide band?

1-10 GHz is shown in the figure.

Ultra-Wideband (UWB)

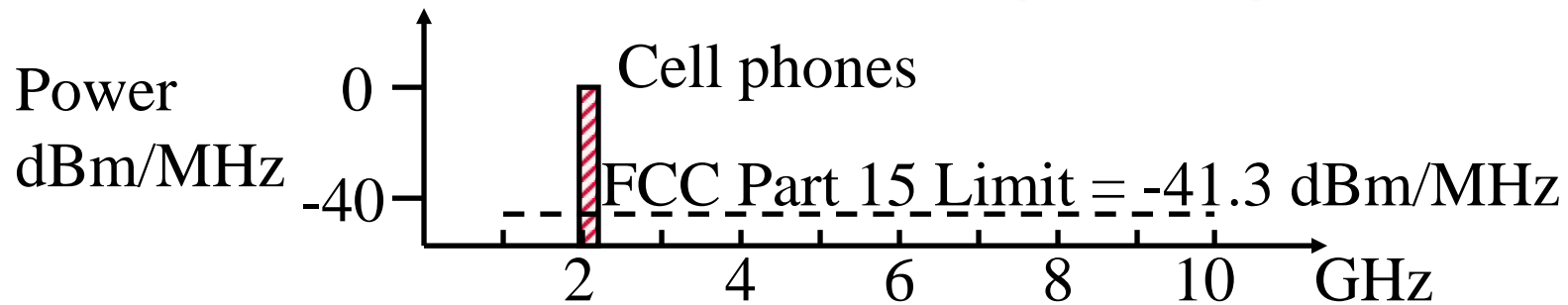

- ❑ FCC rules restrict the maximum noise generated by a wireless equipment ($0 \text{ dBm} = 1 \text{ mW}$, $-40 \text{ dBm} = 0.1 \text{ } \mu\text{W}$)
- ❑ It is possible to generate very short (sub-nano sec) pulses that have a spectrum below the allowed noise level
 \Rightarrow Possible to get Gbps using a 10 GHz spectrum
- ❑ FCC approved UWB operation in 2002
- ❑ UWB can be used for high-speed over short distances
- ❑ UWB can see through trees and underground (radar)
 \Rightarrow collision avoidance sensors, through-wall motion detection
- ❑ Position tracking: cm accuracies. Track high-value assets

Student Questions

- ❑ How does the receiver obtain the signal? Is it listening to the entire frequency band? If a portion of the signal is interfered with by other wireless signals, does this mean the receiver can still retrieve the data by listening to other frequencies?

Yes. This magic happens with Fast Fourier Transforms (FFTs in a manner similar to OFDM.

UWB

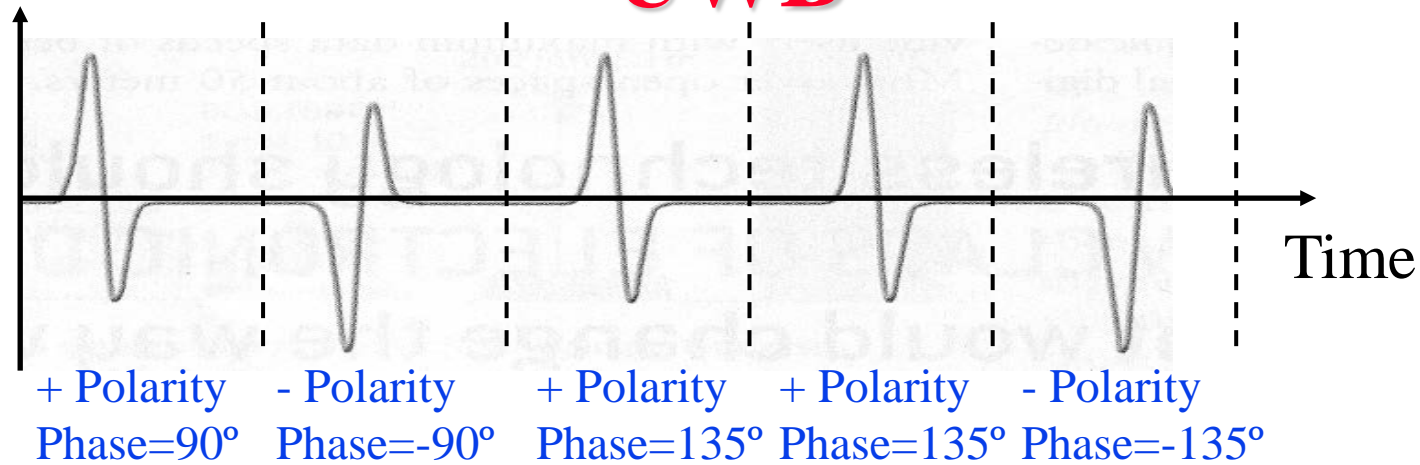

- ❑ Sub-nanosecond impulses are sent many million times per second
- ❑ Became feasible with high-speed switching semiconductor devices
- ❑ Pulse width = 25 to 400 ps
- ❑ Impulses may be position, amplitude, or polarity modulated
- ❑ 0.25 ns Impulse \Rightarrow 4 B pulses/sec \Rightarrow 100's Mbps
- ❑ 802.15.4 uses pulse position and binary phase shift keying modulation

Student Questions

- ❑ In the figures, can you point out which impulse correlated to each of the three (position, amplitude, and polarity modulation)?

See updated figure.

- ❑ What are position, amplitude, and polarity modulations in UWB?

Position modulation \Rightarrow 0 and 1 have different positions in time.

Amplitude modulation \Rightarrow 0 and 1 have different amplitudes.

Polarity modulation \Rightarrow 0 and 1 have different polarities.

- ❑ What does polarity mean in terms of a wireless signal?

Polarization = Direction of vibration relative to the direction of propagation. Stone in a pond results in vertical vibration while the propagation is horizontal. On the other hand, sound propagates with vibrations in the direction of propagation.

[https://en.wikipedia.org/wiki/Polarization_\(waves\)](https://en.wikipedia.org/wiki/Polarization_(waves))

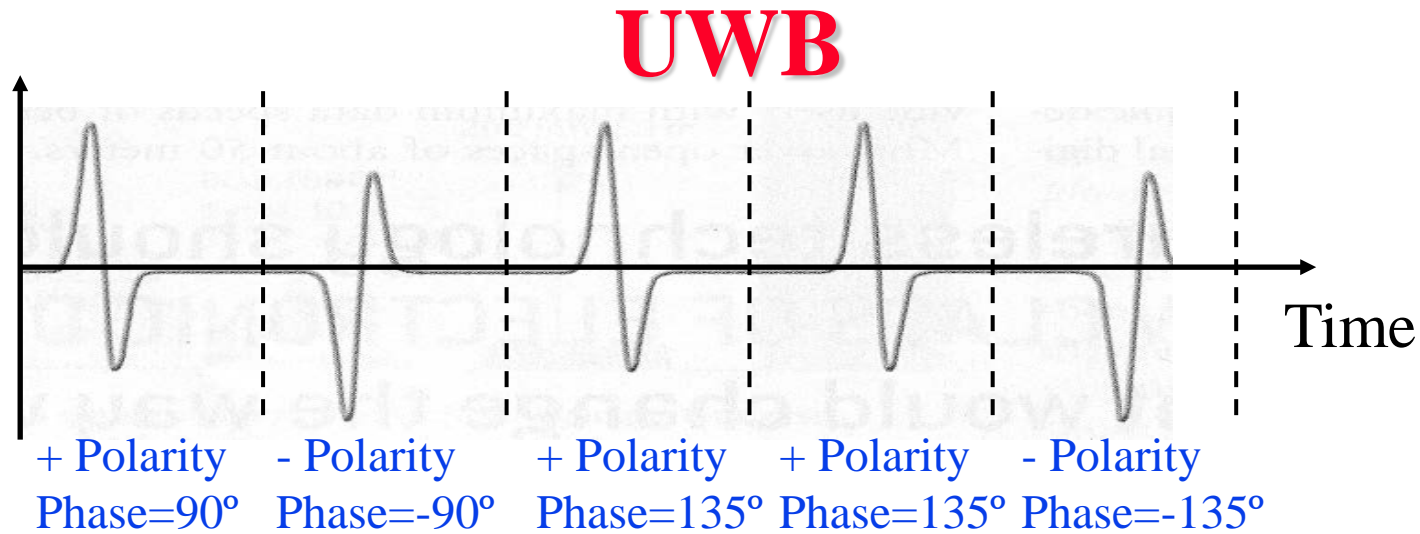

- ❑ Sub-nanosecond impulses are sent many million times per second
- ❑ Became feasible with high-speed switching semiconductor devices
- ❑ Pulse width = 25 to 400 ps
- ❑ Impulses may be position, amplitude, or polarity modulated
- ❑ 0.25 ns Impulse \Rightarrow 4 B pulses/sec \Rightarrow 100's Mbps
- ❑ 802.15.4 uses pulse position and binary phase shift keying modulation

Student Questions

- ❑ How can I tell the phase from the figure?
- ❑ Does the "integral" of the function shows its phase? For example, the integral of the first part is a positive impulse, so it is positive.

Phase requires mapping it to sine waves. See Slide 3-3.

$$X(t) = A \sin(2\pi f t + \theta), \theta = \text{phase}$$

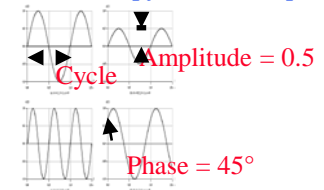

The direction of the first change indicates the phase approximately.

Advantages of UWB

- ❑ Very low energy consumption: Good Watts/Mbps
- ❑ Line of sight not required. Passes through walls.
- ❑ Sub-centimeter resolution allows precise motion detection
- ❑ Pulse width much smaller than path delay
 - ⇒ Easy to resolve multipath
 - ⇒ Can use multipath to advantage
- ❑ Difficult to intercept (interfere)
- ❑ All digital logic ⇒ Low-cost chips
- ❑ Small size: 4.5 mm² in 90 nm process for high data rate designs
- ❑ **UWB is used in iPhone-11 onwards for ranging, path navigation, and tracking.**

Ref: Fine Ranging (FiRA) consortium, <https://www.firaconsortium.org/resource-hub/technical-faq>

Washington University in St. Louis

<http://www.cse.wustl.edu/~jain/cse574-24/>

©2024 Raj Jain

Student Questions

❑ How is path delay an opportunity in UWB?
Due to large path delay and narrow pulses, the reflected signal consists of symbols that do not intersect the main signal. The echo can be discarded easily.

❑ Which property of the UWB gives it sub-centimeter resolution?

Small wavelength and small pulses.

❑ Given that UWB can pass through walls, what is the coverage of this technology?

A few meters.

Direct sequence (DS-UWB)

- ❑ Championed by Motorola/XtremeSpectrum
- ❑ Uses CDMA with multiple chips per bit
- ❑ Chips are encoded using a pulse
- ❑ This is the scheme used in 802.15.4
- ❑ Low power density \Rightarrow Good for body area network

Student Questions

- ❑ Before we talked about how 802.15.4 uses 5 MHz channels in the 2.4 GHz band. Is UWB a different PHY option?

UWB is not in 802.15.4. This module is a merger of two modules: 802.15.4 and UWB. The title should be changed.

IEEE 802.15.4e Enhancements

- ❑ Low latency deterministic operation: pre-assigned slots
- ❑ Channel adaptation: Different channels used by different nodes for a contention-free period
- ❑ Time-slotted channel hopping: Higher layers coordinate the slot allocation along with its frequency. Suitable for harsh industrial environments.
- ❑ Each device can select its listening channel
- ❑ Transmitter and receiver coordinate their cycles (very low duty cycle)
- ❑ Transmit only when requested by the receiver

Student Questions

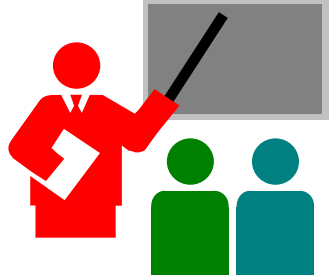

Summary

1. IoT fueled initially by the smart grid is resulting in several competing protocols: Bluetooth Smart, ZigBee Smart, ...
2. IEEE 802.15.4 is a low-data rate wireless personal area network and is the PHY and MAC layer used by many IoT protocols, such as ZigBee and WirelessHART.
3. 802.15.4 uses full-function and reduced-function devices. FFDs can act as coordinators. Allows a star, mesh, or cluster tree topology.
4. Uses Slotted/Unslotted CSMA/CA. Supports Guaranteed timed slots for low-latency applications.
5. UWB allows transmission with very low average power spread over a large band.

Student Questions

Reading List

- ❑ A. Elahi and A. Gschwender, “ZigBee Wireless Sensor and Control Network,” Prentice Hall, 2009, 288 pp., ISBN:0137134851, (Chapters 3 and 4) Safari Book.
- ❑ O. Hersent, et al., “The Internet of Things: Key Applications and Protocols,” Wiley, 2012, 344 pp., ISBN:9781119994350, Safari book.

Student Questions

Homework 12

[13 points] based on the reading list, fill in the blanks.

1. _____ routing is one in which end-nodes help route the messages for others.
2. _____ topology is one in which loops are possible.
3. A _____-function IEEE 802.15.4 device can be coordinator or a router.
4. A _____-function IEEE 802.15.4 device can only be a leaf.
5. Broadcast within a specific group, e.g., police is called _____
6. Each IEEE 802.15.4 node has a _____-bit unique ID. But when it joins a network, it is assigned a _____-bit short ID.
7. IEEE 802.15.4 nodes have a _____-bit universal address.
8. IEEE 802.15.4 nodes use a _____-bit local address during communication.
9. IEEE 802.15.4 uses _____-MHz channels in _____ GHz band.
10. In _____ mode, IEEE 802.15.4 coordinator sends beacons periodically and active interval consists of _____ slots.

Student Questions

- For HW12, question 7, did you mean an OUI or U/M and not a universal address?

Universal = Globally unique

- ❖ Are questions 6a/7 and 6b/8 asking the same thing?

Yes.

- ❖ Since Hw12 is due on the 31st can you publish the answers on canvas in case we got wrong answer!

Thank You. The deadline has been changed to Friday 10/26. Thus, it can be graded by Saturday.

- ❖ In Slide 12-9, we only need to remember the blue part not all?

Yes. Both 12-8 and 12-9.

Wikipedia Pages

- ❑ http://en.wikipedia.org/wiki/Machine_to_machine
- ❑ http://en.wikipedia.org/wiki/Internet_of_Things
- ❑ http://en.wikipedia.org/wiki/IEEE_802.15.4
- ❑ http://en.wikipedia.org/wiki/IEEE_802.15.4a
- ❑ http://en.wikipedia.org/wiki/IEEE_802.15
- ❑ http://en.wikipedia.org/wiki/Chirp_spread_spectrum
- ❑ http://en.wikipedia.org/wiki/Carrier_sense_multiple_access_with_collision_avoidance
- ❑ http://en.wikipedia.org/wiki/Phase-shift_keying
- ❑ http://en.wikipedia.org/wiki/Chirp_spread_spectrum
- ❑ <http://en.wikipedia.org/wiki/Ultra-wideband>
- ❑ http://en.wikipedia.org/wiki/Personal_area_network
- ❑ <http://en.wikipedia.org/wiki/Piconet>
- ❑ <http://en.wikipedia.org/wiki/Scatternet>

Student Questions

References

- ❑ J. T. Adams, "An introduction to IEEE STD 802.15.4" IEEEAC paper #1055, Dec 30, 2005, 8 pp., https://web.sonoma.edu/users/f/farahman/sonoma/courses/cet543/resources/802_intro_01655947.pdf
- ❑ E. Karapistoli, et al., "An overview of the IEEE 802.15.4a Standard," IEEE Communications Magazine, January 2010, pp. 47-53, <http://www.ee.oulu.fi/~kk/dtsp/tutorialit/Karapistoli.pdf>
- ❑ D. Gratton, "The Handbook of Personal Area Networking Technologies and Protocols," Cambridge University Press, August 2013, 424 pp. ISBN: 978-0-521-19726-7, Safari Book
- ❑ I. Guvenc, et al., "Reliable Communications for Short-Range Wireless Systems," Cambridge University Press, March 2011, 426 pp., ISBN: 978-0-521-76317-2, Safari Book
- ❑ D. Raychaudhuri and M. Gerla, "Emerging Wireless Technologies and the Future Mobile Internet," Cambridge University Press, March 2011, 330 pp., ISBN: 978-0-521-11646-6, Safari Book
- ❑ N. Hunn, "Essentials of Short-Range Wireless," Cambridge University Press, July 2010, 344 pp., ISBN: 978-0-521-76069-0, Safari Book

Student Questions

References (Cont)

- ❑ H. Zhou, “The Internet of Things in the Cloud: A Middleware Perspective,” CRC Press, 2013, 365 pp., ISBN: 9781439892992, Safari Book
- ❑ H. Schwetlick, “PSSS-Parallel Sequence Spread Spectrum – A Potential Physical Layer for OBAN?,”
<http://oban.tubit.tu-berlin.de/5-PSSS-Schwetlick.pdf>
- ❑ Z. Ianelli, “Introduction to Chirp Spread Spectrum (CSS) Technology,” IEEE 802 Tutorial,
http://www.ieee802.org/802_tutorials/03-November/15-03-0460-00-0040-IEEE-802-CSS-Tutorial-part1.ppt

Student Questions

Acronyms

- ❑ 6LowPAN IPv6 over Low Power Personal Area Network
- ❑ ACK Acknowledgement
- ❑ AES Advanced Encryption Standard
- ❑ AMCA Asynchronous Multi-Channel Adaptation
- ❑ ANSI American National Standards Institute
- ❑ ANT Name of a company
- ❑ BPM Burst Position Modulation
- ❑ CDMA Code Division Multiple Access
- ❑ CFP Contention Free Period
- ❑ COSEM Company Specification for Energy Metering
- ❑ CPS Cyber-Physical Systems
- ❑ CRC Cyclic Redundancy Check
- ❑ CSMA Carrier Sense Multiple Access
- ❑ CSMA/CA Carrier Sense Multiple Access with Collision Avoidance
- ❑ CSS Chirp Spread Spectrum
- ❑ dBm deci-Bell milli-Watt

Student Questions

Acronyms (Cont)

- ❑ DLMS Device Language Message Specification
- ❑ DQPSK Differential Quadrature Phase-shift keying
- ❑ ETSI European Telecommunications Standards Institute
- ❑ EUI-64 Extended Unique Identifier
- ❑ FCC Federal Communications Commission
- ❑ FFD Full Function device
- ❑ GFSK Gaussian Frequency-Shift Keying
- ❑ GHz Giga Hertz
- ❑ GTS Guaranteed Timed Slots
- ❑ HART Highway Addressable Remote Transducer Protocol
- ❑ ID Identifier
- ❑ IEEE Institution of Electrical and Electronics Engineer
- ❑ IETF Internet Engineering Task Force
- ❑ IoT Internet of Things
- ❑ ISA International Society of Automation
- ❑ IGTHz Interest Group for TeraHertz

Student Questions

Acronyms (Cont)

- ❑ LAN Local Area Network
- ❑ LECIM Low energy critical infrastructure monitoring
- ❑ LIFS Long Inter-frame Spacing
- ❑ LPWAN Low-Power Wide Area Network
- ❑ LR-WPAN Low-Rate Wireless Personal Area Networks
- ❑ LTE Long-Term Evolution
- ❑ MAC Media Access Control
- ❑ MAN Metropolitan Area Network
- ❑ MHz Mega Hertz
- ❑ MiWi Microchip Wireless
- ❑ OUI Organizationally Unique Identifier
- ❑ PAN Personal Area Network
- ❑ PCA Priority Channel Access
- ❑ PHY Physical Layer
- ❑ PLC Powerline Communications
- ❑ PPDU Physical Layer Protocol Data Unit

Student Questions

Acronyms (Cont)

- ❑ PSSH Parallel Sequence Spread Spectrum
- ❑ QPSK Quadrature Phase Shift Keying
- ❑ RFD Reduced Function device
- ❑ RFID Radio Frequency Identifier
- ❑ SCADA Supervisory control and data acquisition
- ❑ SCietf Standing Committee for IETF Liaison
- ❑ SCwng Wireless Next Generation Standing Committee
- ❑ SIFS Short inter-frame spacing
- ❑ ULI Upper Layer Interface
- ❑ UWB Ultra Wide Band
- ❑ WirelessHART Wireless Highway Addressable Remote Transducer Protocol
- ❑ WPAN Wireless Personal Area Network
- ❑ WRAN Wireless Regional Area Network

Student Questions

IEEE 802.15.4 Activities 2020

- ❑ **TG4Cor**: Revision to IEEE Standard 802.15.4-2020 (Task Group)
- ❑ **TG4y**: Security Next Generation
- ❑ **TG4aa** JRE: Japanese Rate Extension
- ❑ **TG7a**: Higher Rate, Longer Range Optical Camera Communications (OCC)
- ❑ **TG13**: Multi-Gigabit/s Optical Wireless Communications
- ❑ **TG16t**: Licensed Narrowband
- ❑ **TG9ma**: 15.9 REV1
- ❑ **SG7a**: High Data Rate (Study Group)
- ❑ **IGdep**: Enhanced Dependability
- ❑ **SCmaintenance**: Maintenance of Standards (Standing Committee)
- ❑ **SCTHz**: Terahertz
- ❑ **SCwng**: Wireless Next Generation

Ref: <http://ieee802.org/15/index.html>

Washington University in St. Louis

<http://www.cse.wustl.edu/~jain/cse574-24/>

©2024 Raj Jain

Student Questions

MAC Frame Format

Frame Control	Seq. #	Dest. PAN Id	Dest. Addr.	Src PAN Id	Src Addr.	Aux. Security Header	Payload	FCS
16b	8b	0/16b	0/16/64b	0/16b	0/16/64b	0/40/48/80/70b		16b

Frame Type	Security enabled	Frame Pending	Ack Reqd	PAN Id Compression	Rsvd	Dest. Addr. Mode	Frame version	Src. Addr. mode
3b	1b	1b	1b	1b	3b	2b	2b	2b



000	Beacon
001	Data
010	Ack
011	MAC Command
Other	Reserved

00	PAN Id and Addr not present
01	Reserved
10	16-bit short address
11	64-bit extended address

Student Questions

Scan This to Download These Slides



Raj Jain

<http://rajjain.com>

Student Questions

http://www.cse.wustl.edu/~jain/cse574-24/j_12wpm.htm

Related Modules



CSE567M: Computer Systems Analysis (Spring 2013),
https://www.youtube.com/playlist?list=PLjGG94etKypJEKjNAa1n_1X0bWWNyZcof

CSE473S: Introduction to Computer Networks (Fall 2011),
https://www.youtube.com/playlist?list=PLjGG94etKypJWOSPMh8Azcg5e_10TiDw



Recent Advances in Networking (Spring 2013),
<https://www.youtube.com/playlist?list=PLjGG94etKypLHyBN8mOgwJLHD2FFIMGq5>

CSE571S: Network Security (Fall 2011),
<https://www.youtube.com/playlist?list=PLjGG94etKypKvzfVtutHcPFJXumyyg93u>



Video Podcasts of Prof. Raj Jain's Lectures,
<https://www.youtube.com/channel/UCN4-5wzNP9-ruOzQMs-8NUw>

Student Questions