

Introduction to Wireless Coding and Modulation

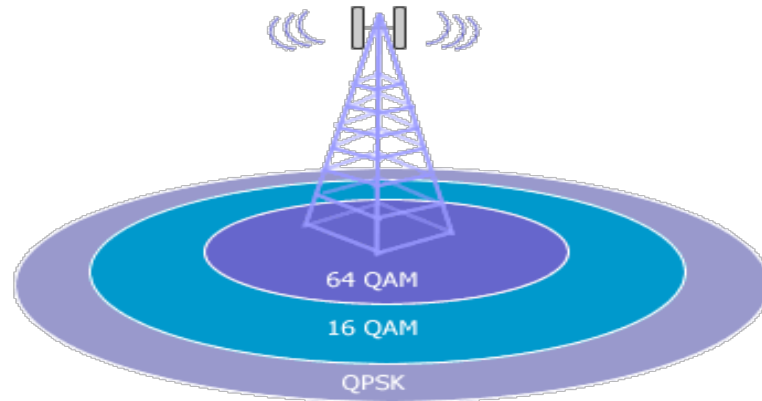

Raj Jain

Professor of Computer Science and Engineering
Washington University in Saint Louis
Saint Louis, MO 63130
Jain@cse.wustl.edu

Audio/Video recordings of this class lecture are available at:

<http://www.cse.wustl.edu/~jain/cse574-20/>

Student Questions



1. Frequency, Wavelength, and Phase
2. Electromagnetic Spectrum
3. Coding and modulation
4. Shannon's Theorem
5. Hamming Distance
6. Multiple Access Methods: CDMA
7. Doppler Shift

Note: This is the 1st in a series of 2 lectures on wireless physical layer. Signal Propagation, OFDM, and MIMO are covered in the next lecture.

Student Questions

Frequency, Period, and Phase

- A $\sin(2\pi ft + \theta)$, A = Amplitude, f=Frequency, θ = Phase, Period $T = 1/f$, Frequency is measured in Cycles/sec or **Hertz**

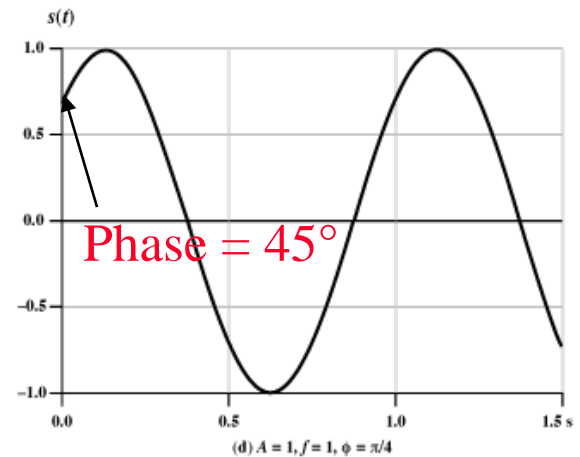
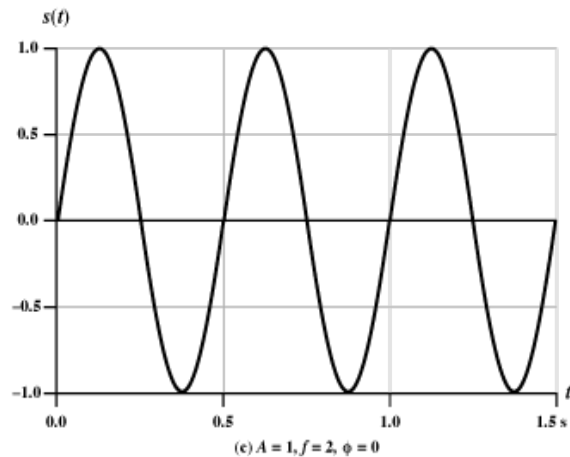
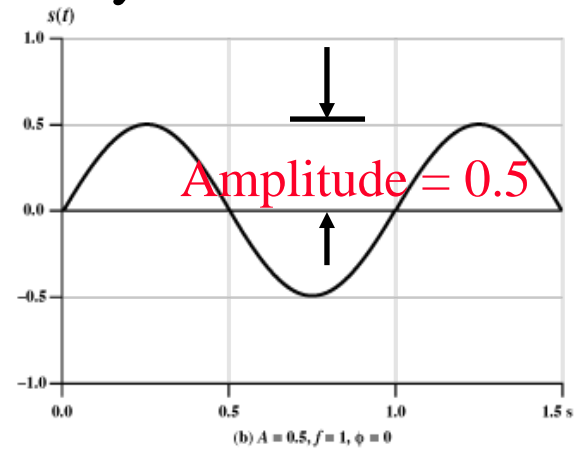
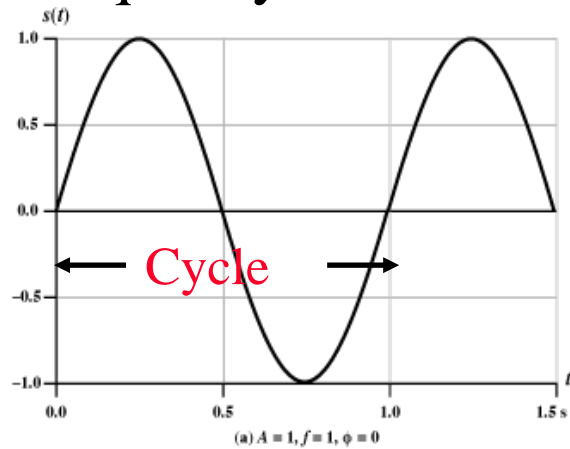

Student Questions

Phase

- Sine wave with a phase of 45°

$$\begin{aligned} \sin(2\pi ft + \frac{\pi}{4}) &= \sin(2\pi ft) \cos(\frac{\pi}{4}) + \cos(2\pi ft) \sin(\frac{\pi}{4}) \\ &= \frac{1}{\sqrt{2}} \sin(2\pi ft) + \frac{1}{\sqrt{2}} \cos(2\pi ft) \end{aligned}$$

In-phase component I + Quadrature component Q

$$Q = A \cos(2\pi ft)$$

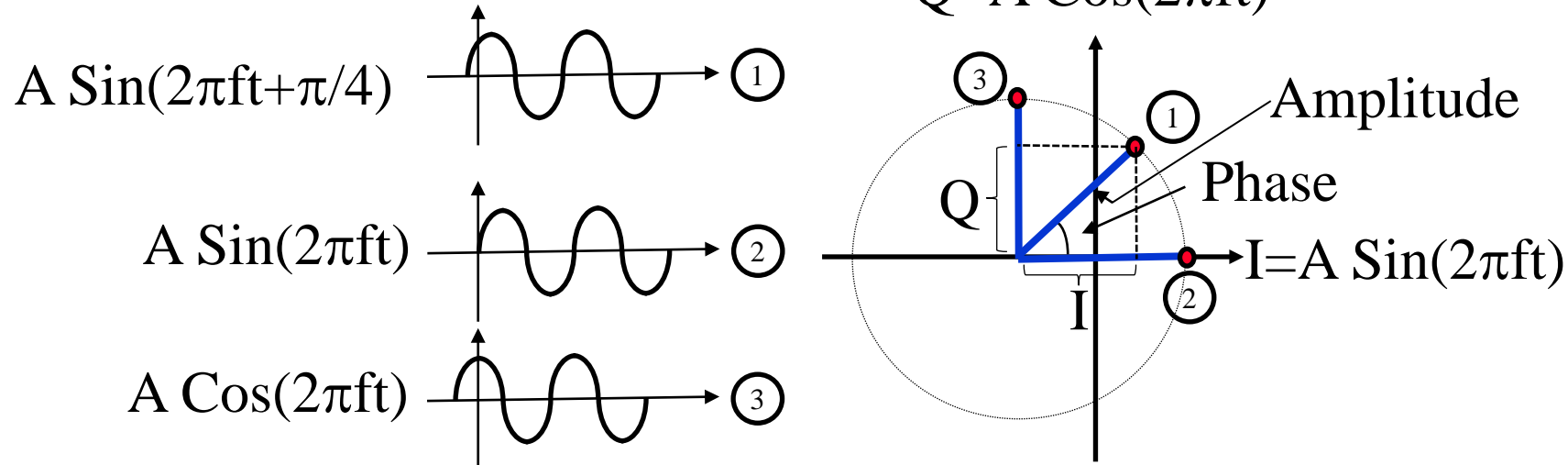

Student Questions

Wavelength

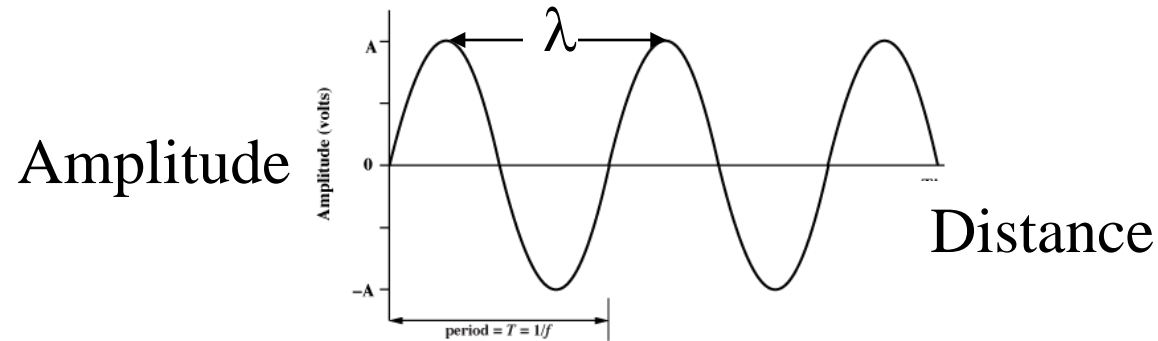

- ❑ Distance occupied by one cycle
- ❑ Distance between two points of corresponding phase in two consecutive cycles
- ❑ Wavelength = λ
- ❑ Assuming signal velocity v
 - $\lambda = vT$
 - $\lambda f = v$
 - $c = 3 \times 10^8 \text{ m/s}$ (speed of light in free space) = *300 m/μs*

Student Questions

Example

- Frequency = 2.5 GHz

$$\begin{aligned}\text{Wavelength} = \lambda &= \frac{c}{f} \\ &= \frac{300 \text{ m}/\mu\text{s}}{2.5 \times 10^9} \\ &= 120 \times 10^{-3} = 120 \text{ mm} = 12 \text{ cm}\end{aligned}$$

Student Questions

Time and Frequency Domains

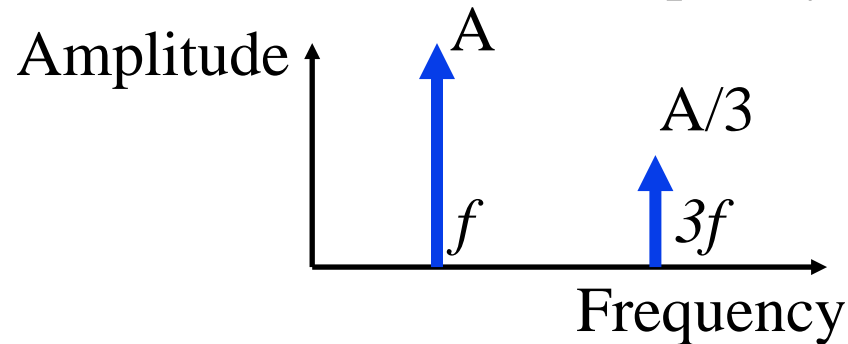
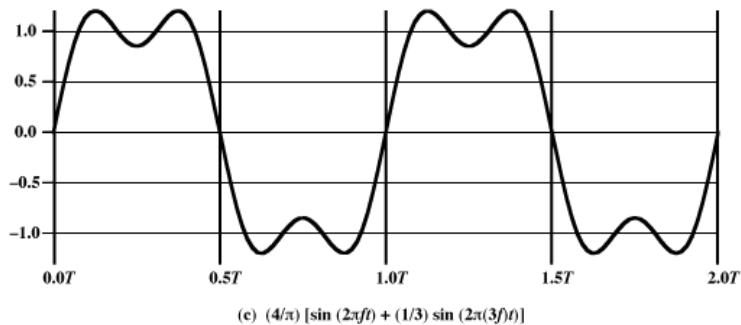
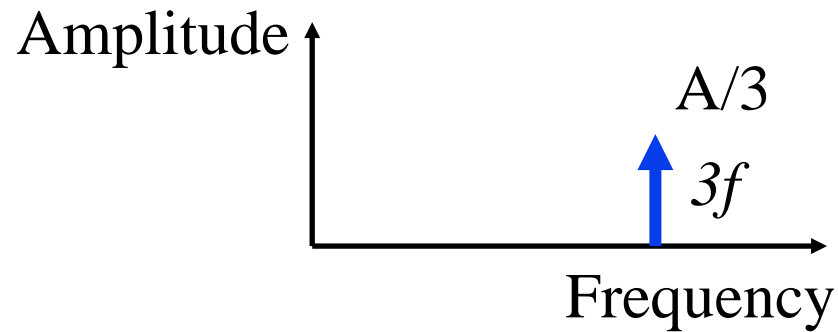
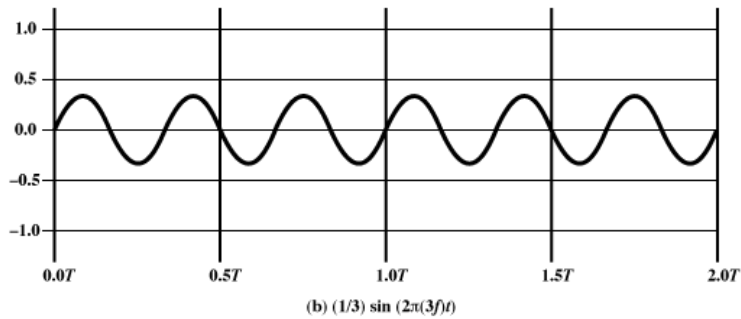
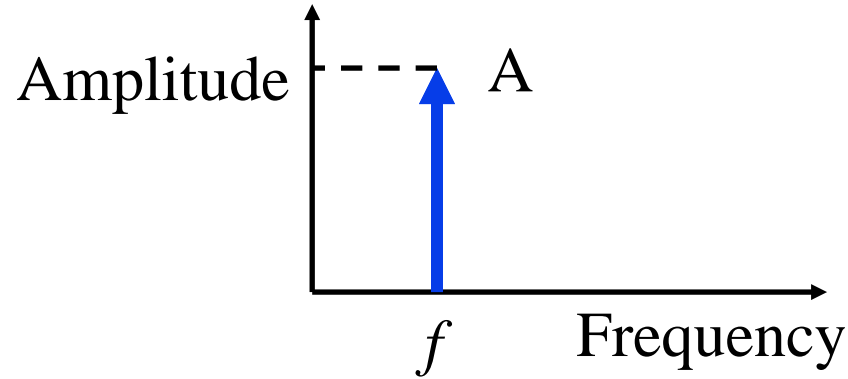
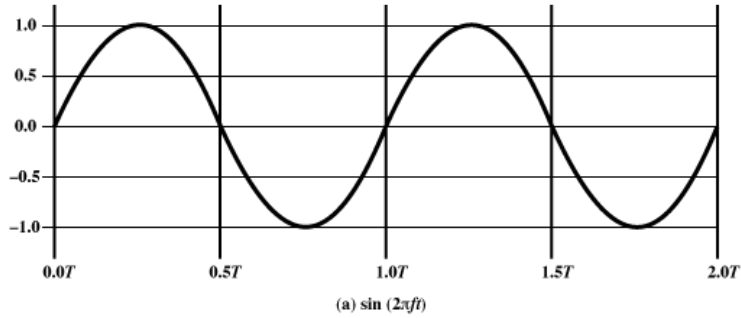

Student Questions

Electromagnetic Spectrum

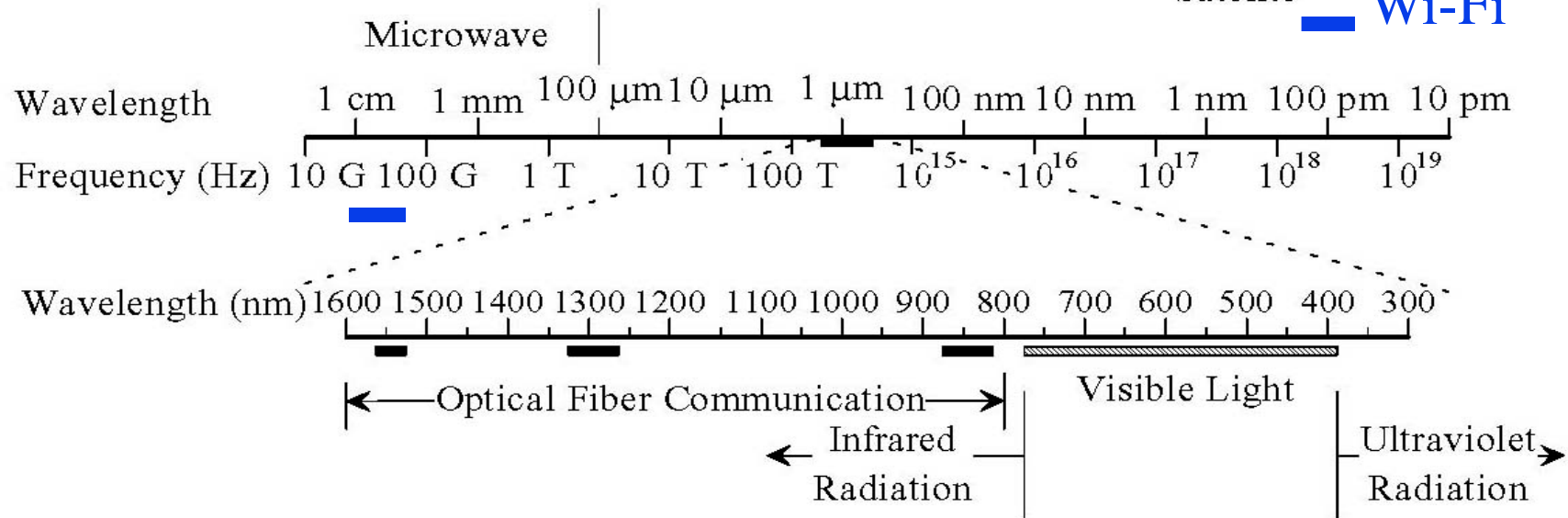
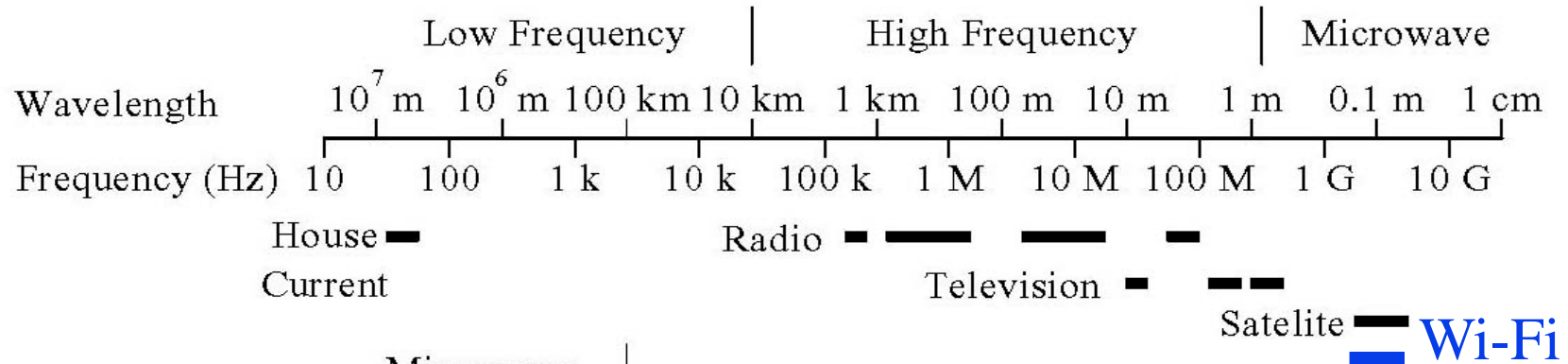

❑ Wireless communication uses 100 kHz to 60 GHz

Student Questions

Decibels

- ❑ Attenuation = $\text{Log}_{10} \frac{P_{in}}{P_{out}}$ Bel
- ❑ Attenuation = $10 \text{Log}_{10} \frac{P_{in}}{P_{out}}$ deciBel
- ❑ Attenuation = $20 \text{Log}_{10} \frac{V_{in}}{V_{out}}$ deciBel Since, $P=V^2I$
- ❑ **Example 1:** $P_{in} = 10 \text{ mW}$, $P_{out}=5 \text{ mW}$
Attenuation = $10 \log_{10} (10/5) = 10 \log_{10} 2 \approx 3 \text{ dB}$
- ❑ **Example 2:** $P_{in} = 100\text{mW}$, $P_{out}=1 \text{ mW}$
Attenuation = $10 \log_{10} (100/1) = 10 \log_{10} 100 = 20 \text{ dB}$

Student Questions

Coding Terminology

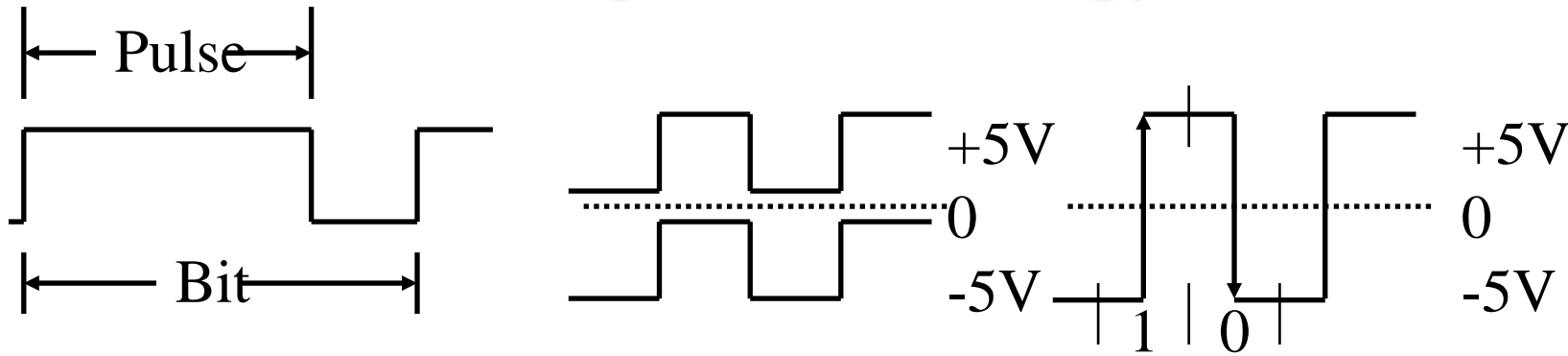

- ❑ **Signal element:** Pulse (of constant amplitude, frequency, phase) = **Symbol**
- ❑ **Modulation Rate:** 1/Duration of the smallest element = Baud rate
- ❑ **Data Rate:** Bits per second

Student Questions

Modulation

- ❑ Digital version of modulation is called **keying**
- ❑ **Amplitude Shift Keying (ASK):**

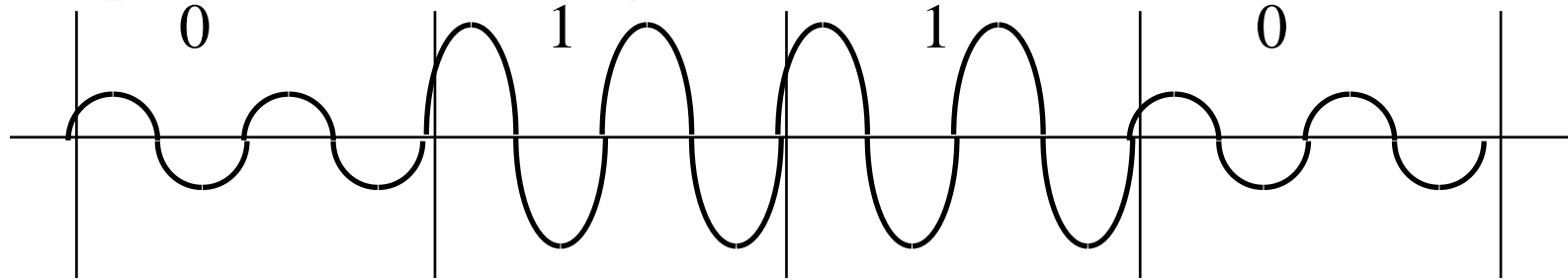

- ❑ **Frequency Shift Keying (FSK):**

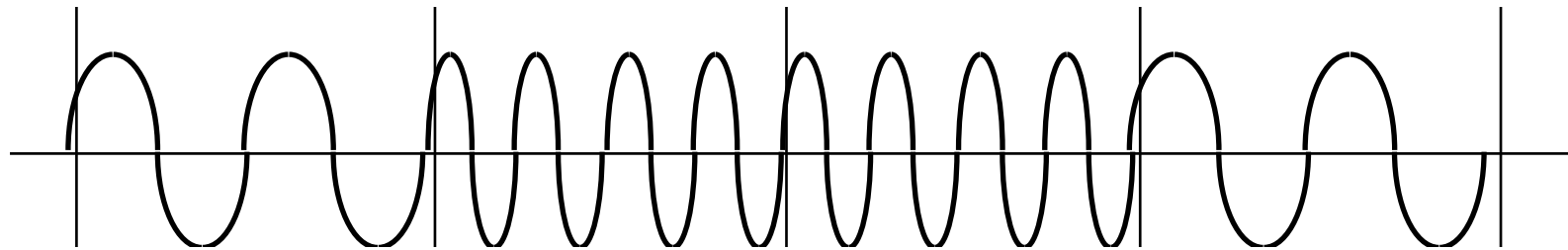

- ❑ **Phase Shift Keying (PSK):** Binary PSK (BPSK)

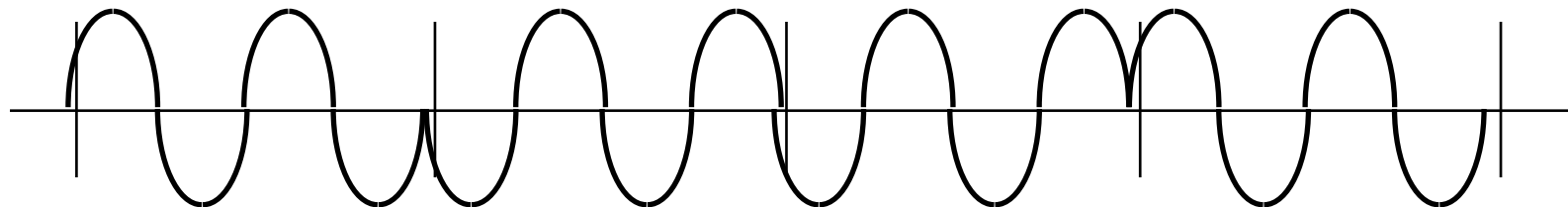

Student Questions

Modulation (Cont)

- **Differential BPSK:** Does not require original carrier

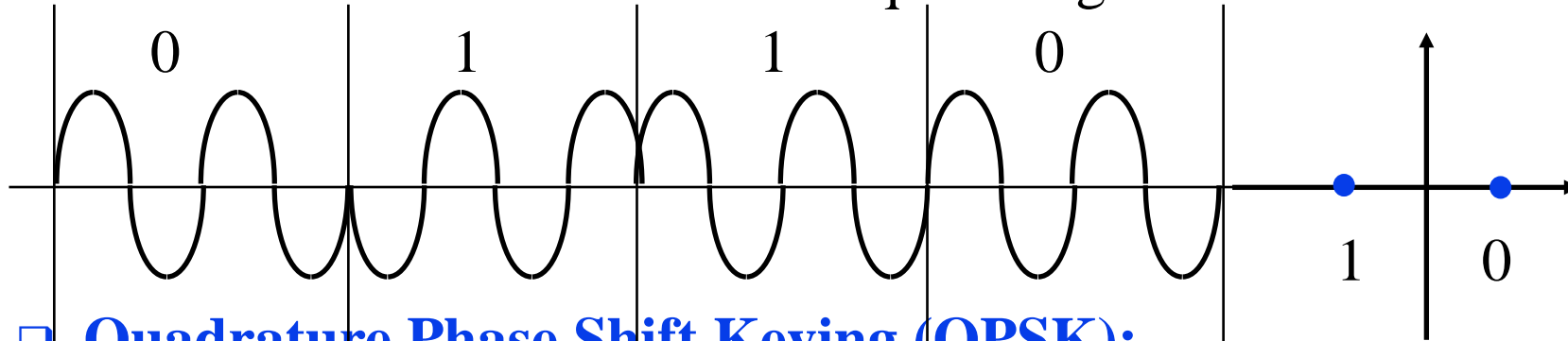

- **Quadrature Phase Shift Keying (QPSK):**

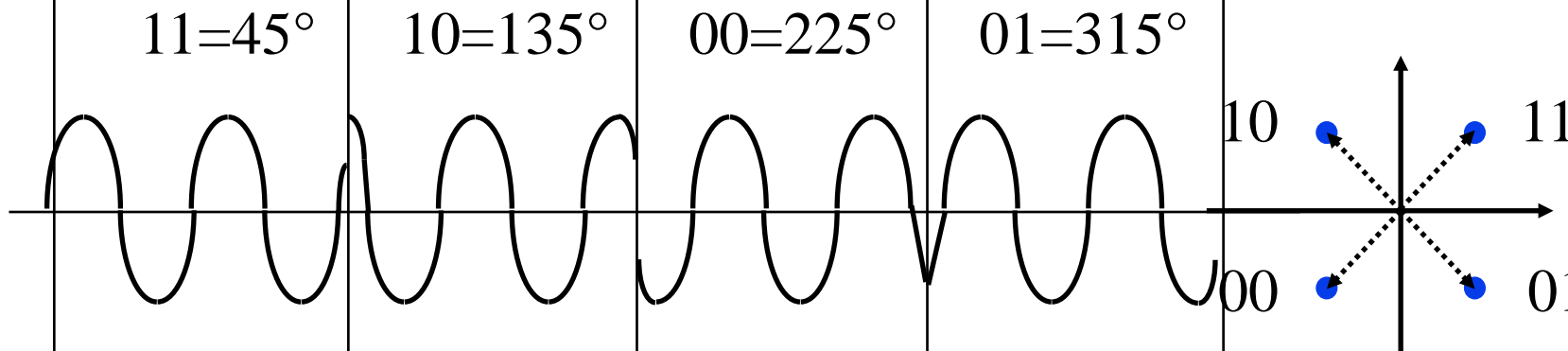

- In-phase (I) and Quadrature (Q) or 90° components are

added
Ref: Electronic Design, "Understanding Modern Digital Modulation Techniques,"
<https://www.electronicdesign.com/communications/understanding-modern-digital-modulation-techniques>

Student Questions

QAM

- ❑ Quadrature Amplitude and Phase Modulation
- ❑ 4-QAM, 16-QAM, 64-QAM, 256-QAM
- ❑ Used in DSL and wireless networks

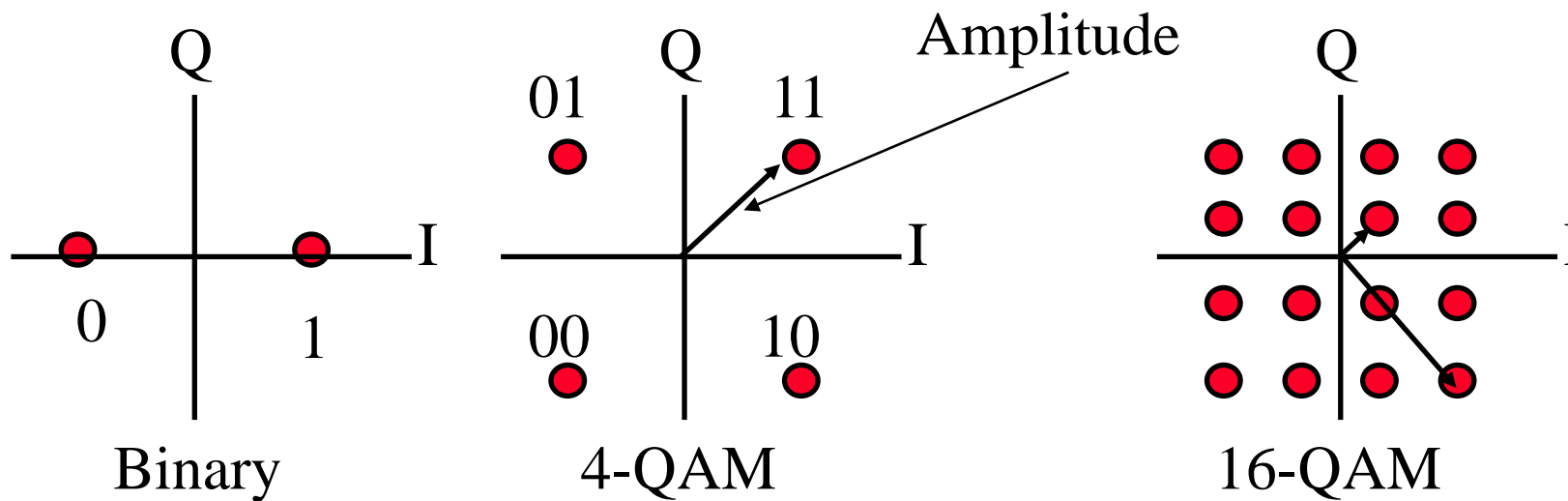

- ❑ 4-QAM \Rightarrow 2 bits/symbol, 16-QAM \Rightarrow 4 bits/symbol, ...

Student Questions

Channel Capacity

- Capacity = Maximum data rate for a channel
- **Nyquist Theorem:** Bandwidth = B
Data rate $\leq 2 B$
- Bi-level Encoding: Data rate = $2 \times$ Bandwidth

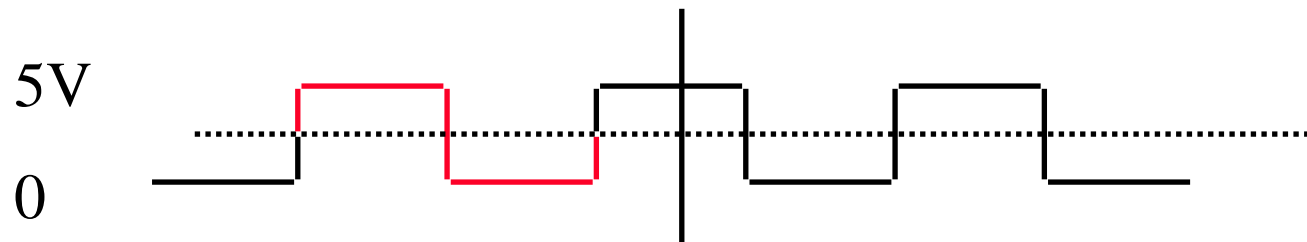

- Multilevel: Data rate = $2 \times$ Bandwidth $\times \log_2 M$
M = Number of levels

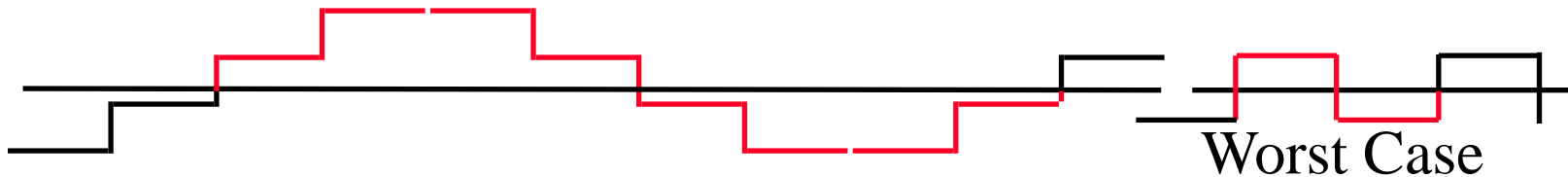

Example: $M=4$, Capacity = $4 \times$ Bandwidth

Student Questions

Shannon's Theorem

- Bandwidth = B Hz
Signal-to-noise ratio = S/N
- Maximum number of bits/sec = $B \log_2 (1+S/N)$
- Example: Phone wire bandwidth = 3100 Hz

$$S/N = 30 \text{ dB}$$

$$10 \text{ Log}_{10} S/N = 30$$

$$\text{Log}_{10} S/N = 3$$

$$S/N = 10^3 = 1000$$

$$\begin{aligned} \text{Capacity} &= 3100 \log_2 (1+1000) \\ &= 30,894 \text{ bps} \end{aligned}$$

Student Questions

Hamming Distance

- Hamming Distance between two sequences
= Number of bits in which they disagree

- Example: 011011
 110001

Difference 101010 \Rightarrow Distance =3

Student Questions

Error Correction Example

- 2-bit words transmitted as 5-bit/word

<u>Data</u>	<u>Codeword</u>
00	00000
01	00111
10	11001
11	11110

Received = 00100 \Rightarrow Not one of the code words \Rightarrow Error

Distance (00100,00000) = 1 Distance (00100,00111) = 2

Distance (00100,11001) = 4 Distance (00100,11110) = 3

\Rightarrow Most likely 00000 was sent. Corrected data = 00

b. Received = 01010 Distance(...,00000) = 2 = Distance(...,11110)

Error detected but cannot be corrected

c. Three bit errors will not be detected. Sent 00000, Received 00111.

Student Questions

Multiple Access Methods



Time Division Multiple Access



Code Division Multiple Access

Student Questions

Frequency Hopping Spread Spectrum

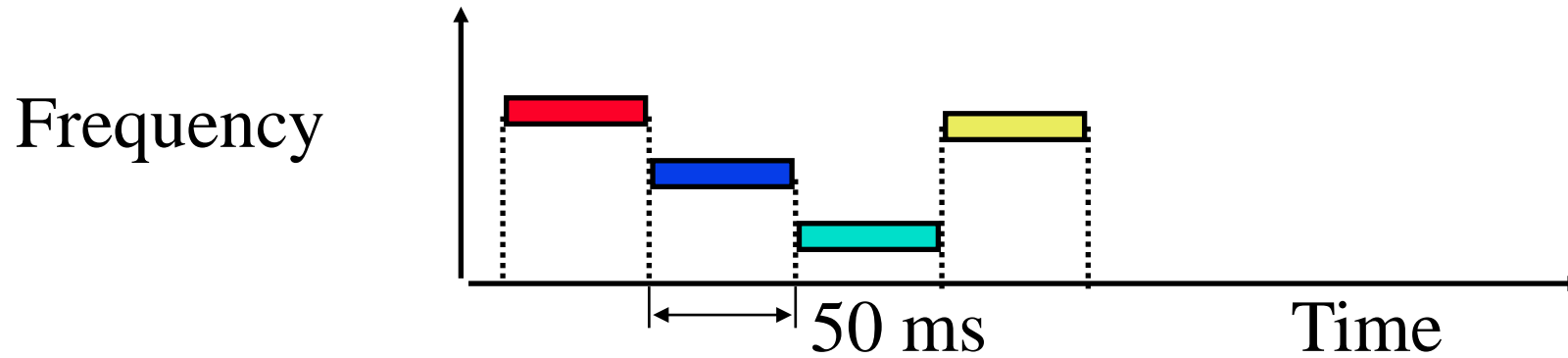

- ❑ Pseudo-random frequency hopping
- ❑ Spreads the power over a wide spectrum
⇒ Spread Spectrum
- ❑ Developed initially for military
- ❑ Patented by actress Hedy Lamarr
- ❑ Narrowband interference can't jam

Student Questions

Spectrum

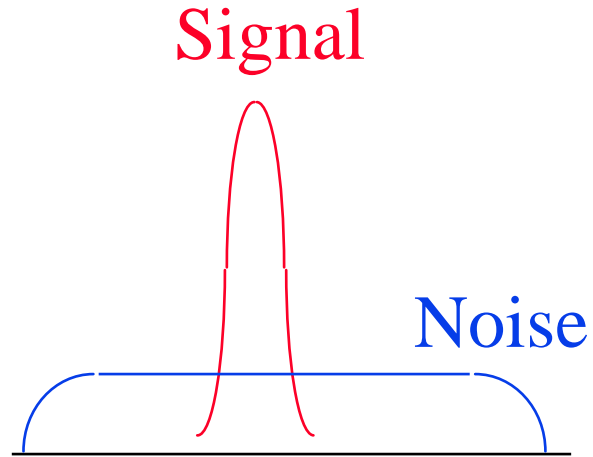

(a) Normal

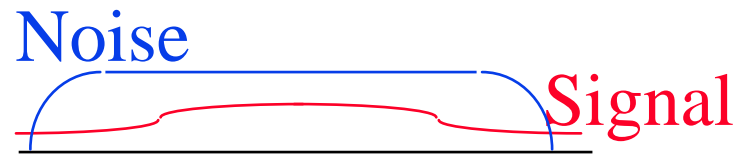

(b) Frequency Hopping

Student Questions

Direct-Sequence Spread Spectrum

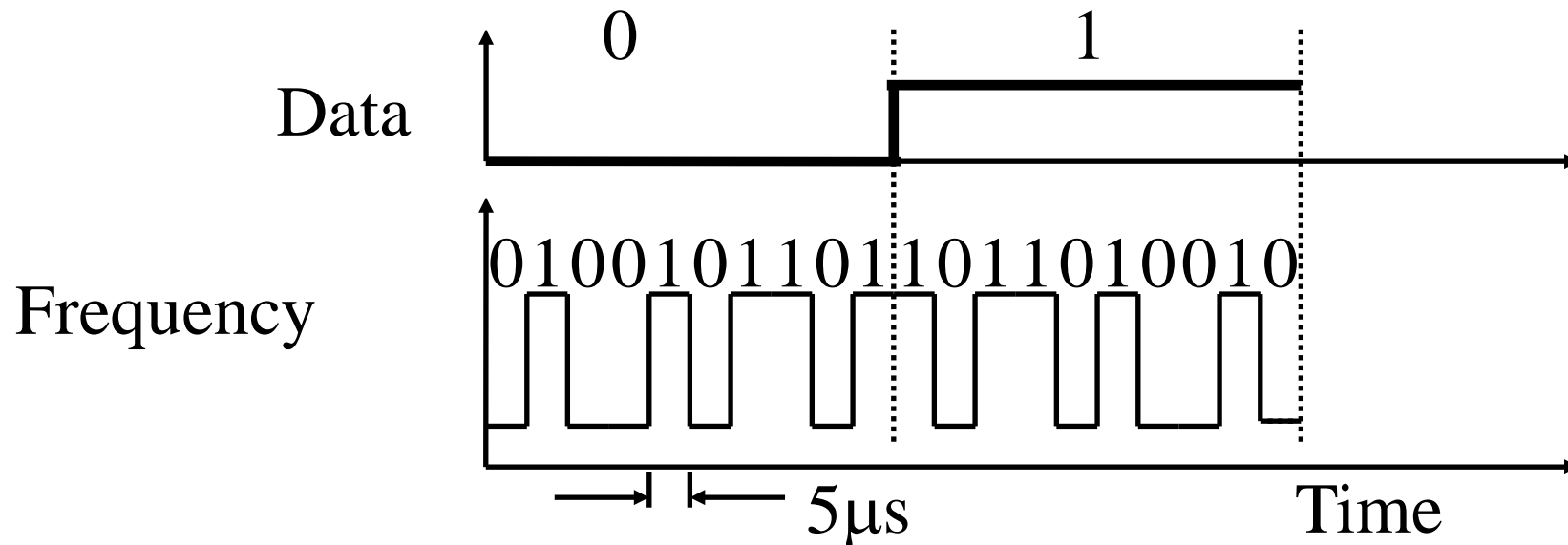

- ❑ Spreading factor = Code bits/data bit, 10-100 commercial (Min 10 by FCC), 10,000 for military
- ❑ Signal bandwidth $>10 \times$ data bandwidth
- ❑ Code sequence synchronization
- ❑ Correlation between codes \Rightarrow Interference Orthogonal

Student Questions

DS Spectrum

Time Domain

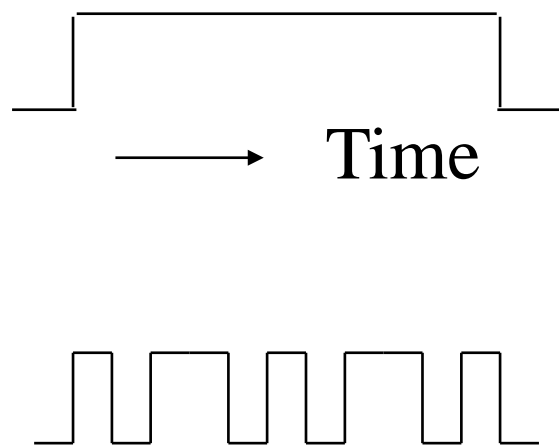

Frequency Domain

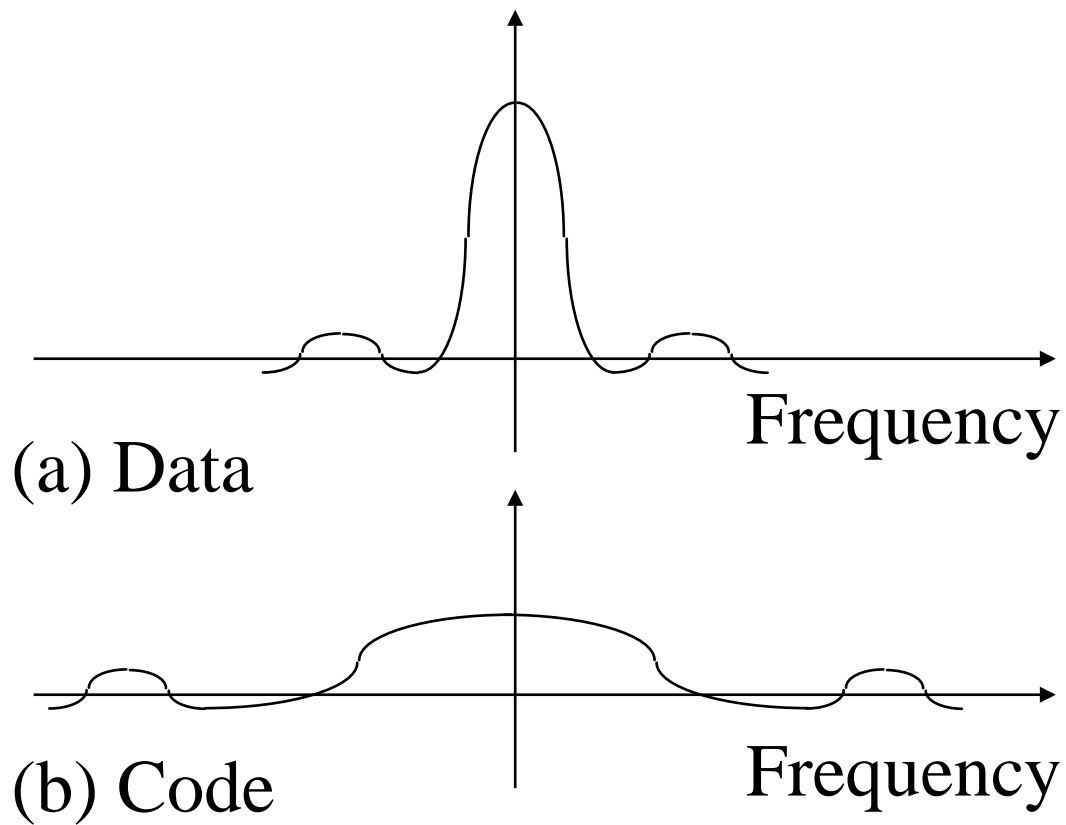

Student Questions

Doppler Shift

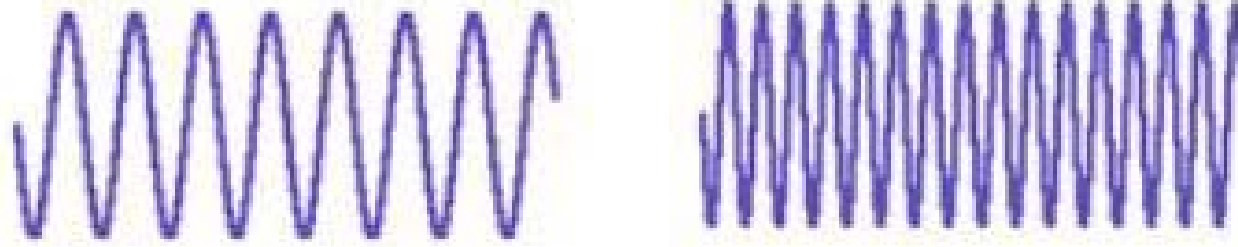

- ❑ If the transmitter or receiver or both are mobile the frequency of received signal changes
- ❑ Moving towards each other \Rightarrow Frequency increases
- ❑ Moving away from each other \Rightarrow Frequency decreases

$$\text{Frequency difference} = \text{velocity}/\text{Wavelength} = v\lambda/c$$

Example: 2.4 GHz $\Rightarrow \lambda = 3 \times 10^8 / 2.4 \times 10^9 = .125\text{m}$

$$120\text{km/hr} = 120 \times 1000 / 3600 = 33.3 \text{ m/s}$$

$$\text{Freq diff} = 33.3 / .125 = 267 \text{ Hz}$$

Student Questions

Doppler Spread and Coherence Time

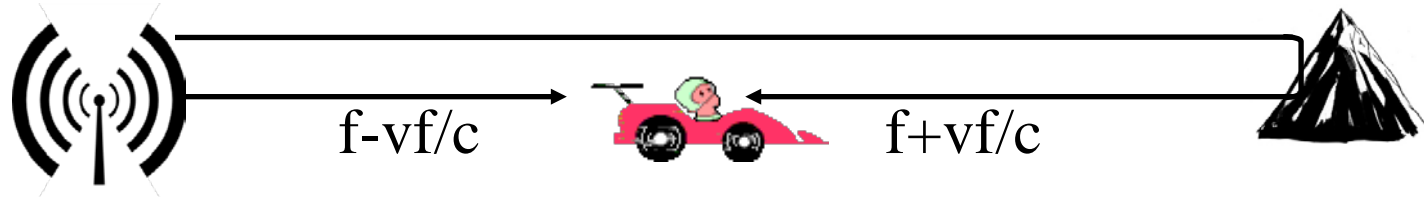

- ❑ Two rays will be received
- ❑ **Doppler Spread** = $2vf/c = 2 \times$ Doppler shift
- ❑ They will add or cancel-out each other as the receiver moves
- ❑ **Coherence time**: Time during which the channel response is constant = $1/\text{Doppler spread}$

Student Questions

Duplexing

- ❑ Duplex = Bi-Directional Communication
- ❑ Frequency division duplexing (FDD) (Full-Duplex)

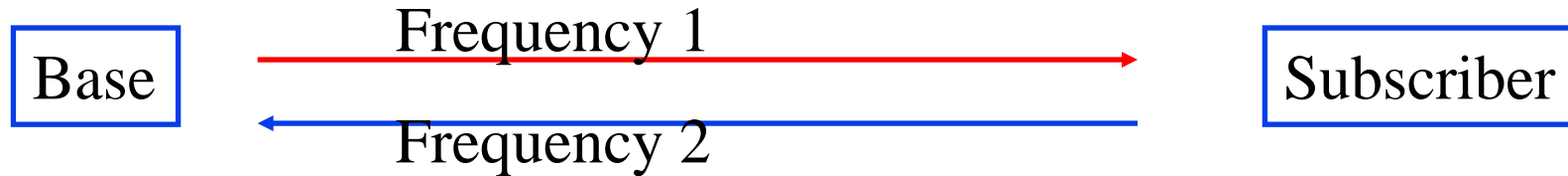

- ❑ Time division duplex (TDD): Half-duplex

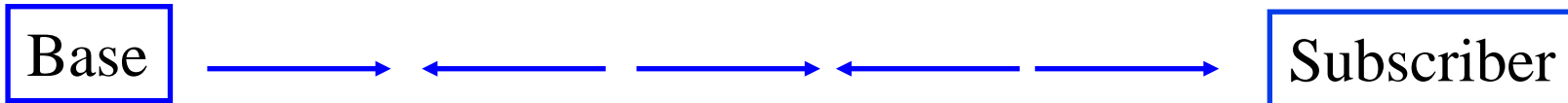

- ❑ Many LTE deployments will use TDD.
 - Allows more flexible sharing of DL/UL data rate
 - Does not require paired spectrum
 - Easy channel estimation \Rightarrow Simpler transceiver design
 - Con: All neighboring BS should time synchronize

Student Questions

Summary

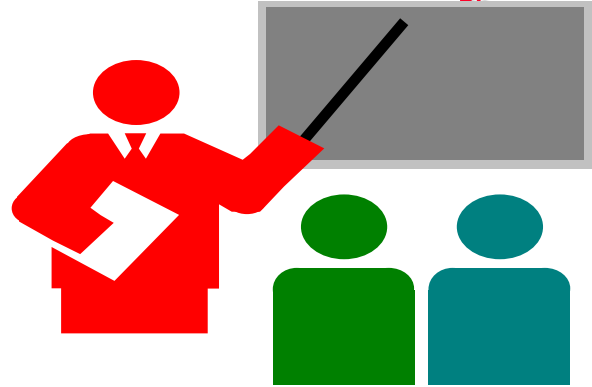

1. Electric, Radio, Light, X-Rays, are all electromagnetic waves
2. Wireless radio waves travel at the speed of light $300 \text{ m}/\mu\text{s}$
Wavelength $\lambda = c/f$
3. 16-QAM uses 16 combinations of amplitude and phase using 4 bits per symbol.
4. Hertz and Bit rate are related by Nyquist and Shannon's Theorems
5. Frequency hopping and Direct Sequence are two methods of code division multiple access (CDMA).

Student Questions

Homework 3

- A. What is wavelength of a signal at 60 GHz?
- B. How many Watts of power is 30dBm?
- C. A telephone line is known to have a loss of 20 dB. The input signal power is measured at 1 Watt, and the output signal noise level is measured at 1 mW. Using this information, calculate the output signal to noise ratio in dB.
- D. What is the maximum data rate that can be supported on a 10 MHz noise-less channel if the channel uses eight-level digital signals?
- E. What signal to noise ratio (in dB) is required to achieve 10 Mbps through a 5 MHz channel?
- F. Compute the average Doppler frequency shift at 36 km/hr using 3 GHz band? Doppler spread is twice the Doppler shift. What is the channel coherence time?

Student Questions

Reading List

- ❑ Electronic Design, “Understanding Modern Digital Modulation Techniques,”
<https://www.electronicdesign.com/communications/understanding-modern-digital-modulation-techniques>
- ❑ Jim Geier, "Designing and Deploying 802.11 Wireless Networks: A Practical Guide to Implementing 802.11n and 802.11ac Wireless Networks, Second Edition," Cisco Press, May 2015, 600 pp., ISBN:1-58714-430-1 (Safari Book), Chapter 2.
- ❑ Jim Geier, "Wireless Networks first-step," Cisco Press, August 2004, 264 pp., ISBN:1-58720-111-9 (Safari Book), Chapter 3.
- ❑ Steve Rackley, “Wireless Networking Technology," Newnes, March 2007, 416 pp., ISBN:0-7506-6788-5 (Safari Book), Chapter 4.

Student Questions

Wikipedia Links

- ❑ <https://en.wikipedia.org/wiki/Frequency>
- ❑ <https://en.wikipedia.org/wiki/Wavelength>
- ❑ [https://en.wikipedia.org/wiki/Phase_\(waves\)](https://en.wikipedia.org/wiki/Phase_(waves))
- ❑ https://en.wikipedia.org/wiki/Quadrature_phase
- ❑ https://en.wikipedia.org/wiki/Frequency_domain
- ❑ https://en.wikipedia.org/wiki/Time_domain
- ❑ https://en.wikipedia.org/wiki/Fourier_transform
- ❑ https://en.wikipedia.org/wiki/Electromagnetic_spectrum
- ❑ <https://en.wikipedia.org/wiki/Decibel>
- ❑ <https://en.wikipedia.org/wiki/DBm>
- ❑ <https://en.wikipedia.org/wiki/Modulation>
- ❑ https://en.wikipedia.org/wiki/Amplitude-shift_keying
- ❑ https://en.wikipedia.org/wiki/Phase-shift_keying
- ❑ https://en.wikipedia.org/wiki/Frequency-shift_keying
- ❑ https://en.wikipedia.org/wiki/Quadrature_phase-shift_keying

Student Questions

Wikipedia Links (Cont)

- ❑ https://en.wikipedia.org/wiki/Differential_coding
- ❑ https://en.wikipedia.org/wiki/Quadrature_amplitude_modulation
- ❑ https://en.wikipedia.org/wiki/Shannon%E2%80%93Hartley_theorem
- ❑ https://en.wikipedia.org/wiki/Channel_capacity
- ❑ https://en.wikipedia.org/wiki/Hamming_distance
- ❑ https://en.wikipedia.org/wiki/Channel_access_method
- ❑ https://en.wikipedia.org/wiki/Time_division_multiple_access
- ❑ https://en.wikipedia.org/wiki/Frequency-division_multiple_access
- ❑ <https://en.wikipedia.org/wiki/CDMA>
- ❑ https://en.wikipedia.org/wiki/Spread_spectrum
- ❑ https://en.wikipedia.org/wiki/Direct-sequence_spread_spectrum
- ❑ https://en.wikipedia.org/wiki/Frequency-hopping_spread_spectrum
- ❑ https://en.wikipedia.org/wiki/Doppler_effect
- ❑ [https://en.wikipedia.org/wiki/Duplex_\(telecommunications\)](https://en.wikipedia.org/wiki/Duplex_(telecommunications))
- ❑ https://en.wikipedia.org/wiki/Time-division_duplex
- ❑ http://en.wikipedia.org/wiki/Frequency_division_duplex

Student Questions

Optional Listening Material

Those not familiar with modulation, coding, CRC, etc may want to listen to the following lectures from CSE473S:

- ❑ Transmission Media,
http://www.cse.wustl.edu/~jain/cse473-11/i_1cni.htm
- ❑ Signal Encoding Techniques,
http://www.cse.wustl.edu/~jain/cse473-05/i_5cod.htm
- ❑ Digital Communications Techniques,
http://www.cse.wustl.edu/~jain/cse473-05/i_6com.htm

Student Questions

Acronyms

- ❑ ASK Amplitude Shift Keying
- ❑ BPSK Binary Phase Shift Keying
- ❑ BS Base Station
- ❑ CDMA Code division multiple access
- ❑ CRC Cyclic Redundancy Check
- ❑ dB Decibel
- ❑ dBm Decibel milliWatt
- ❑ DL Downlink
- ❑ DS Direct Sequence
- ❑ DSL Digital Subscriber Line
- ❑ FCC Federal Communications Commission
- ❑ FDD Frequency Division Duplexing
- ❑ FSK Frequency Shift Keying
- ❑ GHz Giga Hertz
- ❑ LAN Local Area Network
- ❑ MHz Mega Hertz

Student Questions

Acronyms (Cont)

- ❑ mW milli Watt
- ❑ OFDM Orthogonal Frequency Division Multiplexing
- ❑ PSK Phase Shift Keying
- ❑ QAM Quadrature Amplitude Modulation
- ❑ QPSK Quadrature Phase Shift Keying
- ❑ SS Subscriber Station
- ❑ TDD Time Division Duplexing
- ❑ UL Uplink

Student Questions

Scan This to Download These Slides



Raj Jain

<http://rajjain.com>

Student Questions

http://www.cse.wustl.edu/~jain/cse574-20/j_03phy.htm

Related Modules



CSE567M: Computer Systems Analysis (Spring 2013),
https://www.youtube.com/playlist?list=PLjGG94etKypJEKjNAa1n_1X0bWWNyZcof

CSE473S: Introduction to Computer Networks (Fall 2011),
https://www.youtube.com/playlist?list=PLjGG94etKypJWOSPMh8Azcg5e_10TiDw



Advances in Networking (Spring 2013),
<https://www.youtube.com/playlist?list=PLjGG94etKypLHyBN8mOgwJLHD2FFIMGq5>

CSE571S: Network Security (Fall 2011),
<https://www.youtube.com/playlist?list=PLjGG94etKypKvzfVtutHcPFJXumyyg93u>



Video Podcasts of Prof. Raj Jain's Lectures,
<https://www.youtube.com/channel/UCN4-5wzNP9-ruOzQMs-8NUw>

Student Questions