

# Introduction to 4G LTE-Advanced



**Raj Jain**

Washington University in Saint Louis

Saint Louis, MO 63130

Jain@cse.wustl.edu

Audio/Video recordings of this class lecture are available at:

<http://www.cse.wustl.edu/~jain/cse574-20/>

**Student Questions**



1. LTE-Advanced: Requirements and New Technologies
2. Carrier Aggregation
3. Coordinated Multipoint Operation
4. Small Cells
5. Inter-Cell Interference Coordination

Note: This is the 3<sup>rd</sup> lecture in a series of lectures on 1G to 5G.  
4.5G and 5G are covered in subsequent modules.

## Student Questions

# What is 4G?

- ❑ International Mobile Telecommunication (IMT) Advanced
- ❑ Requirements in ITU M.2134-2008
- ❑ IP based packet switch network
- ❑ 1.0 Gbps peak rate for fixed services with 100 MHz
- ❑ 100 Mbps for mobile services. High mobility to 500 km/hr

Feature	Cell	Cell Edge	Peak
DL Spectral Efficiency (bps/Hz)	2.2	0.06	15
UL Spectral Efficiency (bps/Hz)	1.4	0.03	6.75

- ❑ Seamless connectivity and global roaming with smooth handovers
- ❑ High-Quality Multimedia
- ❑ ITU has approved two technologies as 4G (Oct 2010)
  - LTE-Advanced
  - WiMAX Release 2 (IEEE 802.16m-2011)

## Student Questions

# LTE-Advanced Requirements

- ❑ UMTS Rel. 10, 2011H1
- ❑ **Goal:** To meet and exceed IMT-advanced requirements
- ❑ **Data Rate:** 3 Gbps downlink, 1.500 Gbps uplink (low mobility) using 100 MHz
- ❑ **Spectral Efficiency:** 30 bps/Hz using 8x8 MIMO downlink, 15 bps/Hz assuming 4x4 MIMO uplink
- ❑ **Cell Spectral Efficiency:** DL 3.7 bps/Hz/cell assuming 4x4 MIMO, 2.4 bps/Hz/cell assuming 2x2 MIMO (IMT-Adv requires 2.6 bps/Hz/cell)
- ❑ **Downlink Cell-Edge Spectral Efficiency:** 0.12 bps/Hz/User assuming 4x4 MIMO, 0.07 bps/Hz/user assuming 2x2 MIMO (IMT-Adv requires 0.075 bps/Hz/user)

Ref: 3GPP, "Requirements for Further Advancements for E-UTRA (LTE-Advanced)," 3GPP TR 36.913 v8.0.1 (03/2009),  
[http://www.3gpp.org/ftp/specs/archive/36\\_series/36.913/](http://www.3gpp.org/ftp/specs/archive/36_series/36.913/)

## Student Questions

# LTE-Advanced Requirements (Cont)

- ❑ **Latency:** Less than 10 ms from dormant to active;  
Less than 50 ms from camped to active
- ❑ **Mobility:** up to 500 kmph
- ❑ **Spectrum Flexibility:** FDD and TDD, Wider channels up to 100 MHz

## Student Questions

# LTE Advanced Techniques

- ❑ **Three Key Factors:** Spectrum (Band, Bandwidth), Spectral Efficiency, and Cell sizes
- ❑ **Bandwidth:** 100 MHz using carrier aggregation  
5 carriers allowed now. 32 in future.  
Higher UE power  $\Rightarrow$  Used if high throughput needed
- ❑ **Spectral Efficiency:**
  - Frequency Reuse Factor of 1
  - Higher order MIMO (8x8 DL, 4x4 UL)
  - New MIMO Techniques: Single-user uplink MIMO
  - Inter-Cell Interference Co-ordination and cancellation
- ❑ **Cell Sizes:**
  - Relays
  - Home eNB

## Student Questions

# Carrier Aggregation

- ❑ Aggregation = Combine multiple bands (Component Carriers)

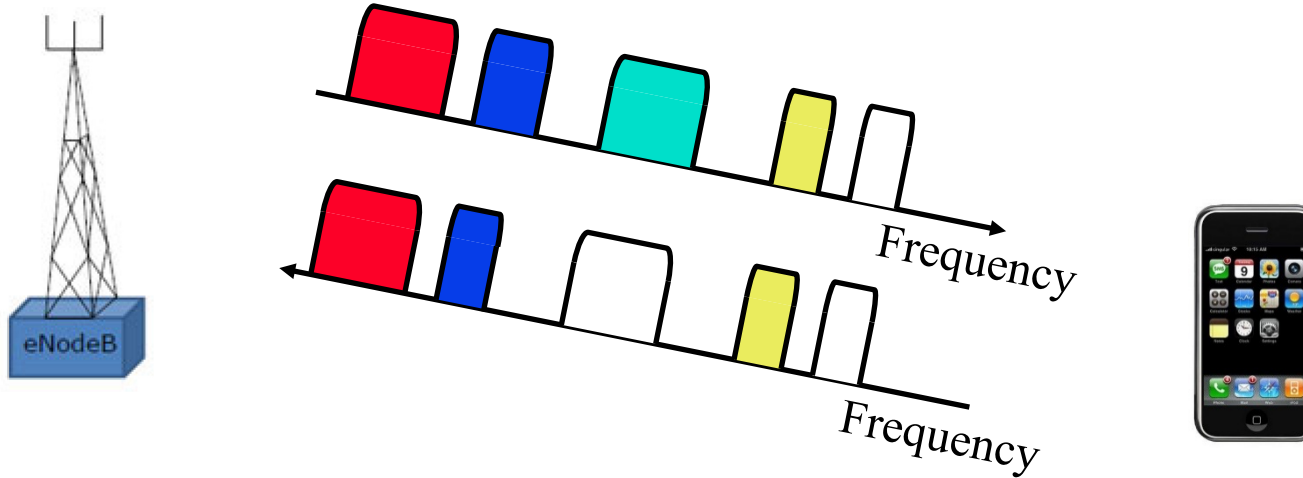

- ❑ Backward compatible with LTE (Single carrier)  
⇒ Each band can be 1.4, 3, 5, 10, or 20 MHz
- ❑ Maximum 5 component carriers ⇒ 100 MHz max
- ❑ Each component can be different width
- ❑ Number of components in DL and UL can be different, but  
Number of components in DL  $\geq$  Number of components in UL

## Student Questions

# Carrier Aggregation (Cont)

- ❑ Components can be contiguous (adjacent) or non-contiguous (inter-band or intra-band)
- ❑ Each component carrier has a serving cell.  
Size of different component carrier cells may differ
- ❑ PHY, MAC, RLC are all extended to handle varying number of components  
e.g., Larger buffers in RLC to accommodate larger data rate

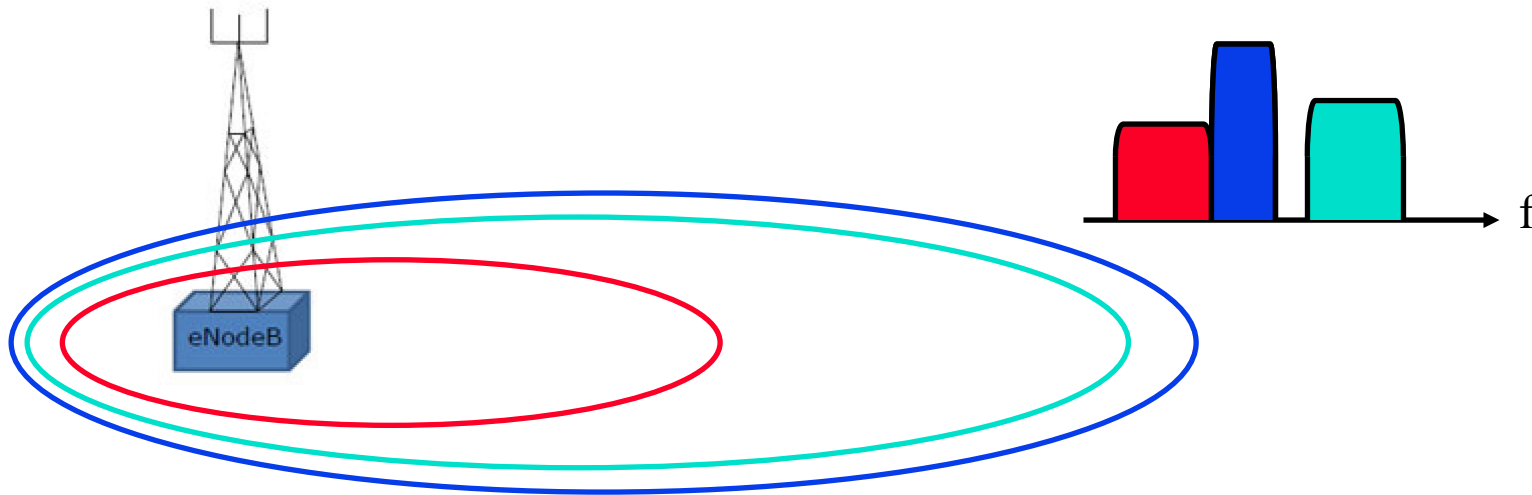

## Student Questions

Ref: <http://www.3gpp.org/technologies/keywords-acronyms/97-lte-advanced>

Washington University in St. Louis

<http://www.cse.wustl.edu/~jain/cse574-20/>

©2020 Raj Jain



# MIMO

- ❑ 8x8 MIMO in DL and 4x4 in UL
- ❑ MIMO used only when SINR is high  $\Rightarrow$  Good Channel
- ❑ If SINR is low, other spectral efficiency techniques, such as, transmit diversity, are used.
- ❑ Many different transmission modes defined.  
UE is informed about the mode to use via signaling
- ❑ Modes differ in number of antennas, antenna port, precoding type, type of reference signal
- ❑ Three new categories of UE: Category 6, 7, 8  
Category 8 supports maximum features

## Student Questions

# Precoding

- ❑ Used to map the modulation symbols to different antennas  
Depends upon the number of antennas and number of **layers**
- ❑ Reference (Pilot) signals are transmitted with the data
- ❑ **Code-Book based precoding**: Cell Reference Signals (CRS)
- ❑ **Non-Code book based precoding**: Demodulation Reference Signals (DM-RS) are added before precoding.  
Receiver can infer precoding from the pilots.

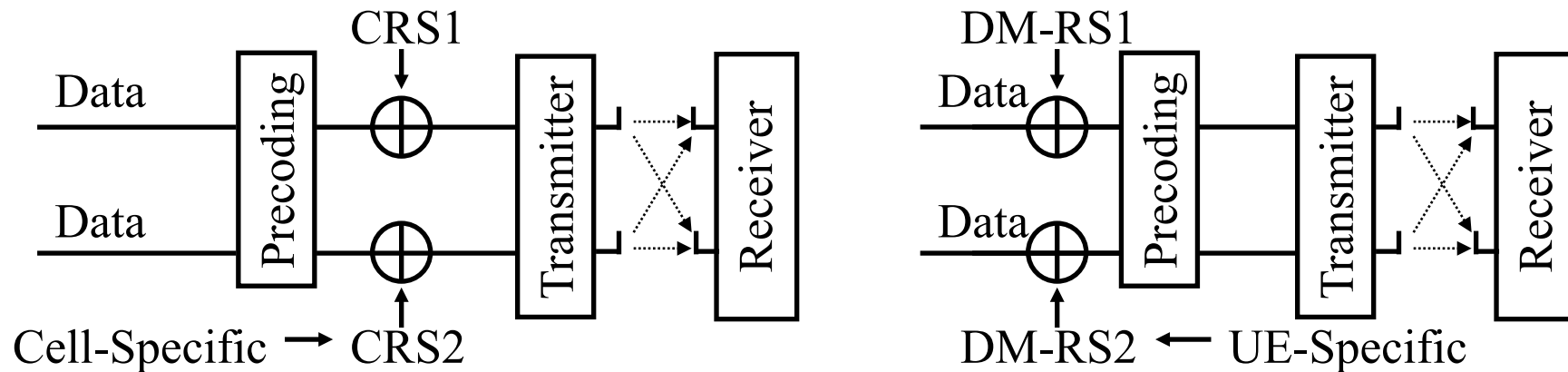

## Student Questions

# Coordinated Multipoint Operation (CoMP)

- ❑ To improve performance at cell edge
- ❑ Base stations coordinate transmissions and reception
- ❑ Joint Transmission: Multiple transmitters in the same subframe
- ❑ Dynamic Point Selection: Transmission scheduled from one BS
- ❑ Joint Reception: Multiple BS receive the signal from one UE and combine
- ❑ UE is informed about different UL/DL decisions

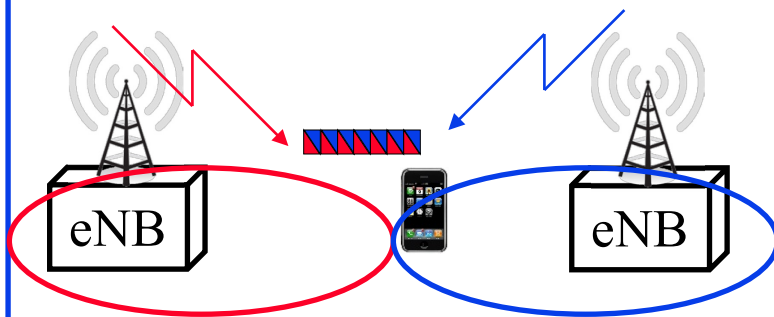

(a) Joint Transmission

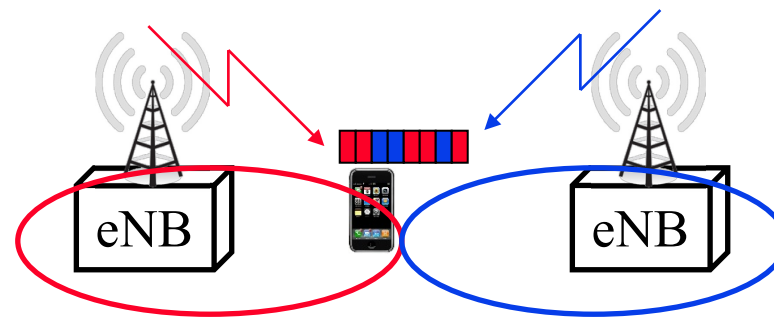

(b) Dynamic Point Selection

## Student Questions

# Relay Nodes

- ❑ **Relay Nodes:** Low-power base stations  
Used to enhance performance at cell edges, hot-spot areas, indoor coverage
- ❑ **Donor eNB (DeNB):** Primary base station
- ❑ A modified version of E-UTRAN air interface Uu is defined:  
Un
- ❑ Both Donor and Relays may use the same/different frequencies
- ❑ Self-Interference: Relay transmission may interfere with its reception on the same frequency  
⇒ Avoided using time sharing
- ❑ Donor does the mobility management

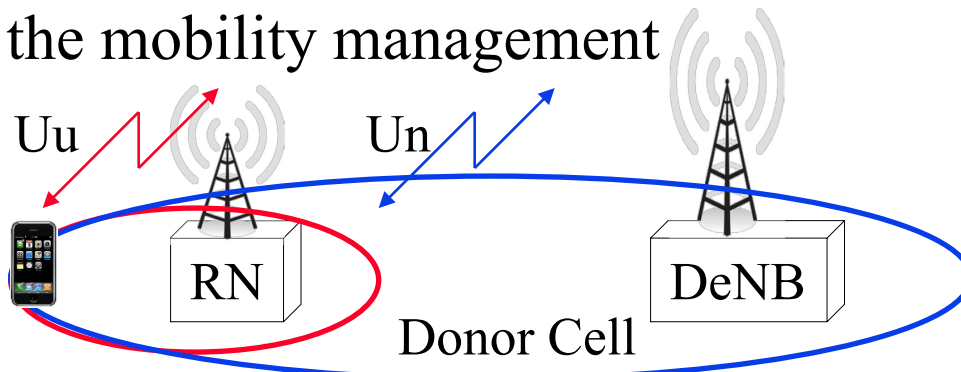

## Student Questions

# HetNet/Small Cells

- ❑ **Macro eNB:** Normal Base Station
- ❑ **Relay Node (RN):** Micro or Pico Cell.
- ❑ **HeNB:** Home eNB for indoor coverage in homes, offices, malls. Privately owned and operated. Femto Cell.
- ❑ **Remote Radio Heads (RRH):** Relay nodes connected to DeNB via fiber

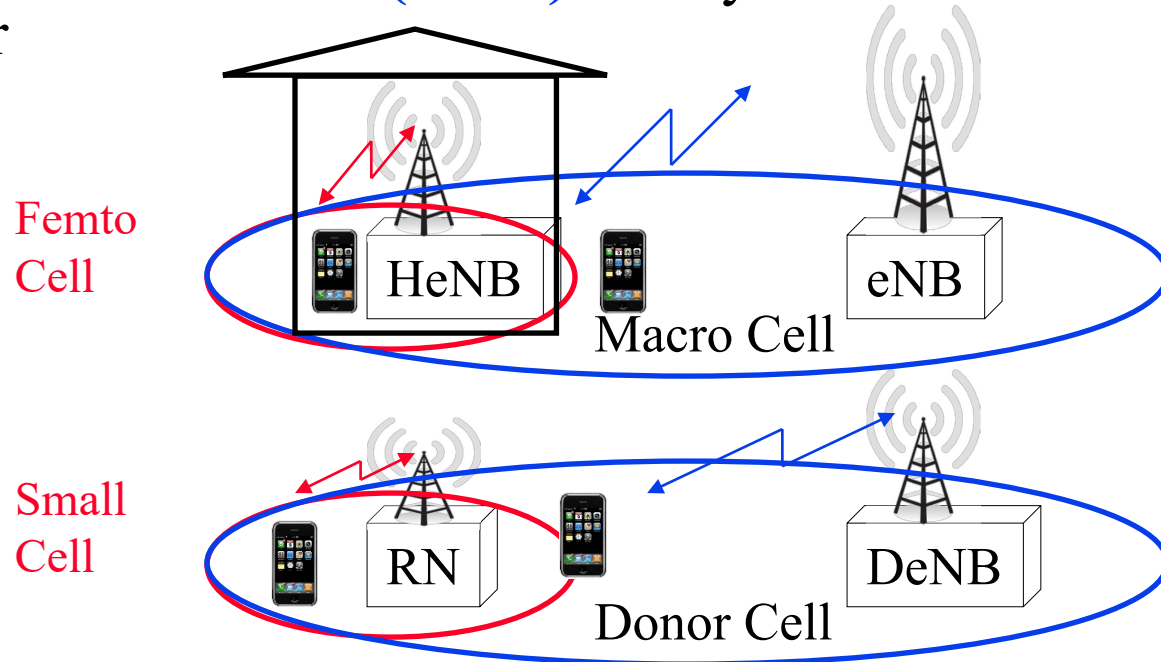

## Student Questions

Ref: 3GPP, "HetNet/Small Cells," <http://www.3gpp.org/hetnet>

Washington University in St. Louis

<http://www.cse.wustl.edu/~jain/cse574-20/>

©2020 Raj Jain

# HetNet/Small Cells (Cont)

- ❑ UE selects the BS with the strongest Signal in DL (SSDL)  
⇒ Both BS have same SSDL at the edge
- ❑ **Cell Range Extension (CRE)**: Allow small cell to serve more users by requiring UE to join small cell even if the power is slightly below the macro cell ⇒ Interference from macro is mitigated by coordination

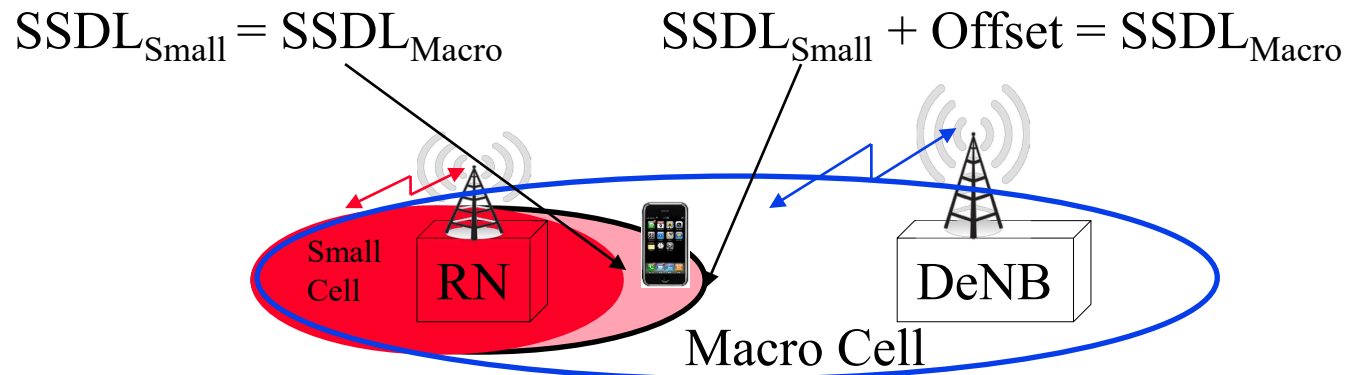

## Student Questions

# Types of Cells

- ❑ **Cell (MacroCell)**: Cover a few miles. Public Access. Open Area.
- ❑ **MicroCell** ( $10^{-6}$ ): Less than a mile wide. Public Access. Malls, Hotels, Train Stations
- ❑ **PicoCell** ( $10^{-12}$ ): in-Building with public access
- ❑ **FemtoCell** ( $10^{-15}$ ): In-Building with restricted access
- ❑ **AttoCell** ( $10^{-18}$ ): In-room
- ❑ **ZeptoCell** ( $10^{-21}$ ): On-Desk
- ❑ No milli, nano cells.

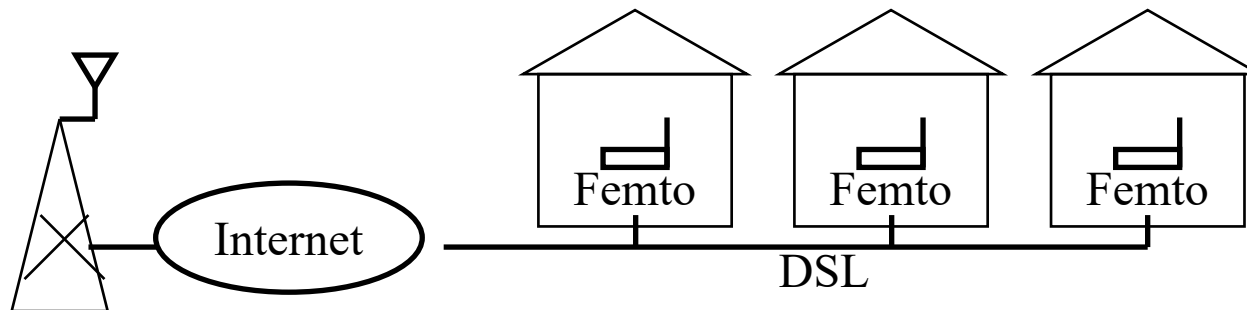

## Student Questions

# FemtoCells: Key Features

- ❑ 50-100 m cell radius
- ❑ Indoor
- ❑ Residential, Small office/home office (SOHO)
- ❑ Backhaul over DSL
- ❑ Plug and Play: *Self-Organizing*, Self optimizing
- ❑ Omni-directional antenna. No sectorization
- ❑ 10-50 users, 10-40 Mbps, Low cost
- ❑ Defined User group
- ❑ Continuation of Macro network: Handover of calls
- ❑ Regular mobile equipment work in femtocells
- ❑ Multiple FemtoCells should coexist
- ❑ New Applications: HD video streaming, LAN services

## Student Questions



# Self-Organizing Network (SON)

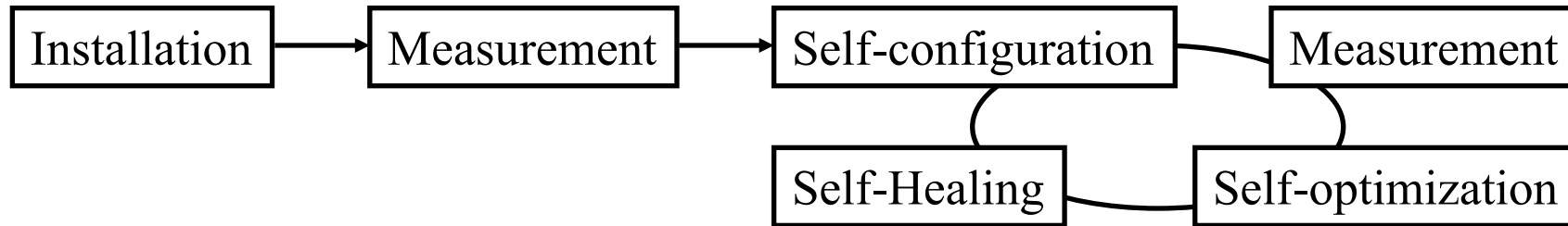

- ❑ User installable. 70M UMTS femtocells expected in 2012
- ❑ Not-physically accessible to the carrier
- ❑ Operator provides femtocell ID. Customer registers location
- ❑ Self-Configures:
  - Transmission Frequencies
  - Transmission Power
  - Preamble: Identifies the segment (IDcell). Some IDs for reserved for femtocells. Helps differentiate from macrocell.
  - Neighbor Cell list: Helps in handover
- ❑ Turned on/off by the consumer ⇒ Dynamic topology

## Student Questions

# Management and Configuration

- ❑ Self-Configuration
- ❑ Remote configuration by service provider
- ❑ Femtocell senses the channel to detect neighboring cells
- ❑ May broadcast messages for neighbors

## Student Questions

# Enhanced Inter-Cell Interference Coordination (eICIC)

- ❑ **ICIC**: A eNB sends a “load information” message to the neighbor eNB about interference level per physical resource block. The neighbor adjusts DL power levels at those blocks
- ❑ **Almost Blank Subframes (ABS)**: Only control channels and cell-specific pilots, no user data  $\Rightarrow$  Allows UEs in CRE region to mitigate macro-cell interference = eICIC

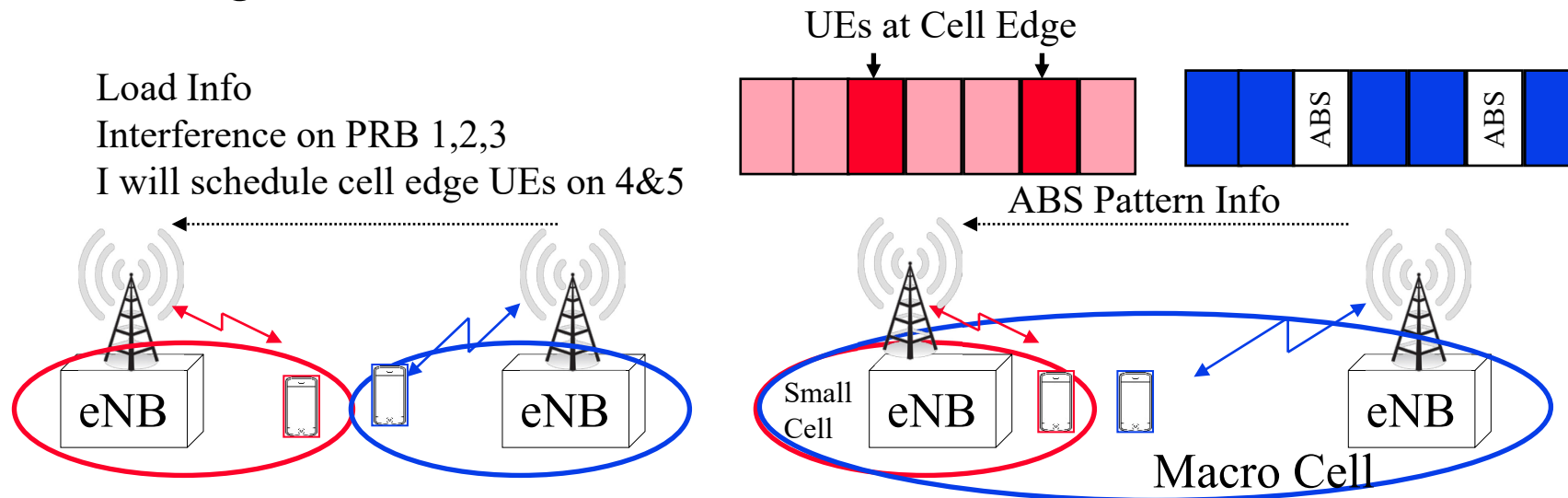

## Student Questions

# Carrier Aggregation with Cross-Carrier Scheduling

- ❑ **Physical DL Control channel (PDCCH)** in macro cell and small cell is sent on different carriers and may be at a higher power than traffic channels
- ❑ A UE can talk to both BS's using control channels on different carriers

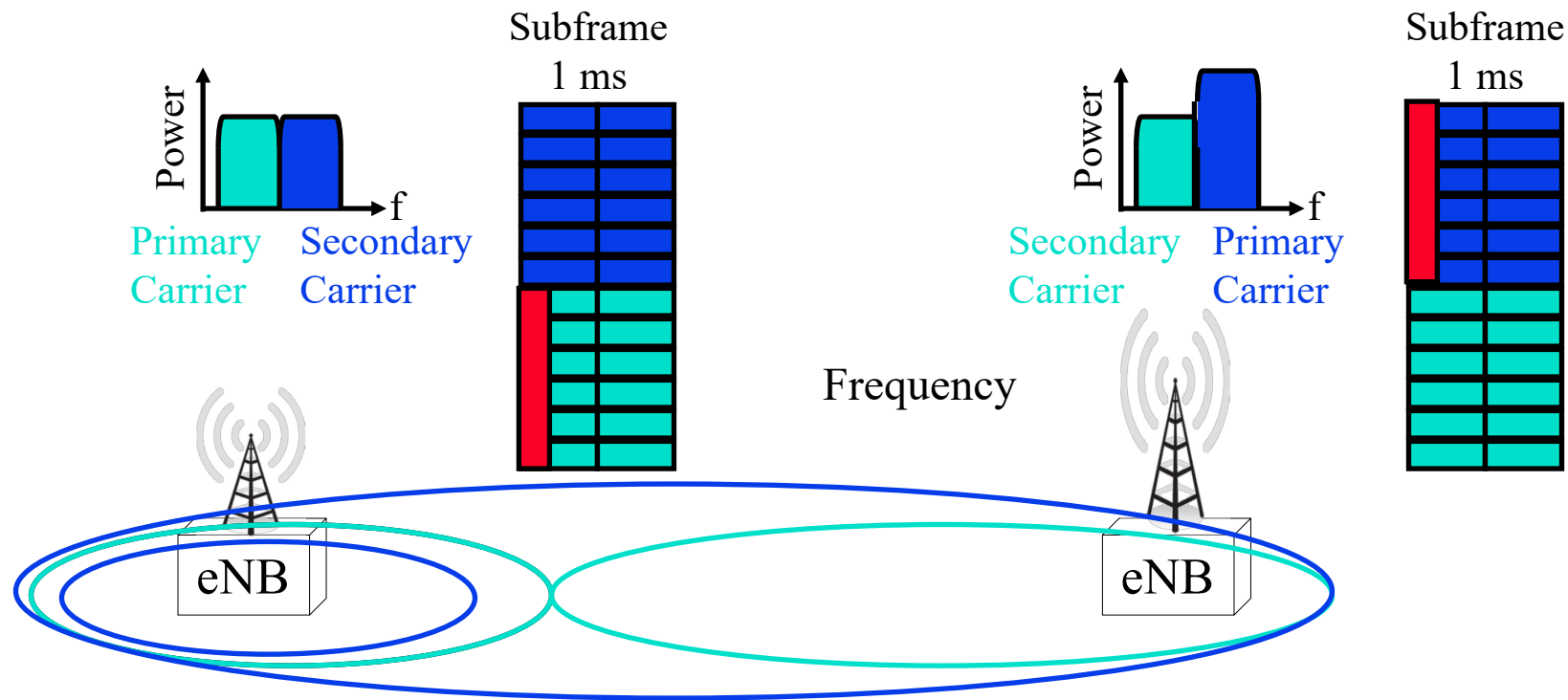

## Student Questions

# CoMP with Small Cells

- A UE can get service from multiple BSs (eNB, RN, HeNB, RRH)
  - Can get data through multiple BSs
  - Can send data through multiple BSs
  - Can send data to one BS and receive from another

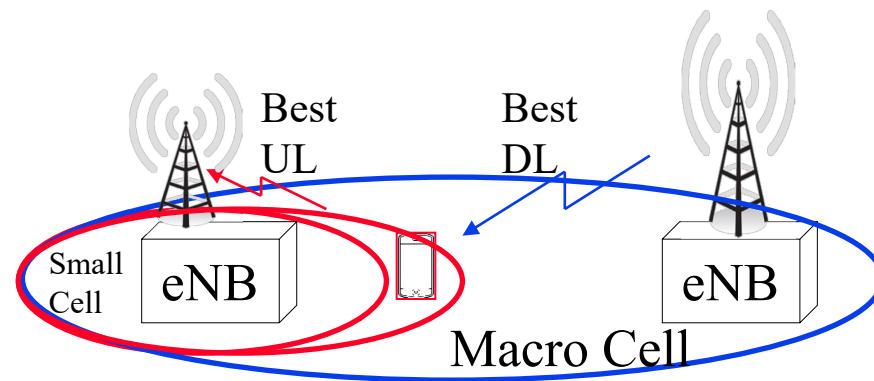

## Student Questions

# Multimedia Broadcast Multicast Service (MBMS)

- ❑ MBMS Single Frequency Network (MBSFN)
- ❑ MCE handles synchronized data delivery

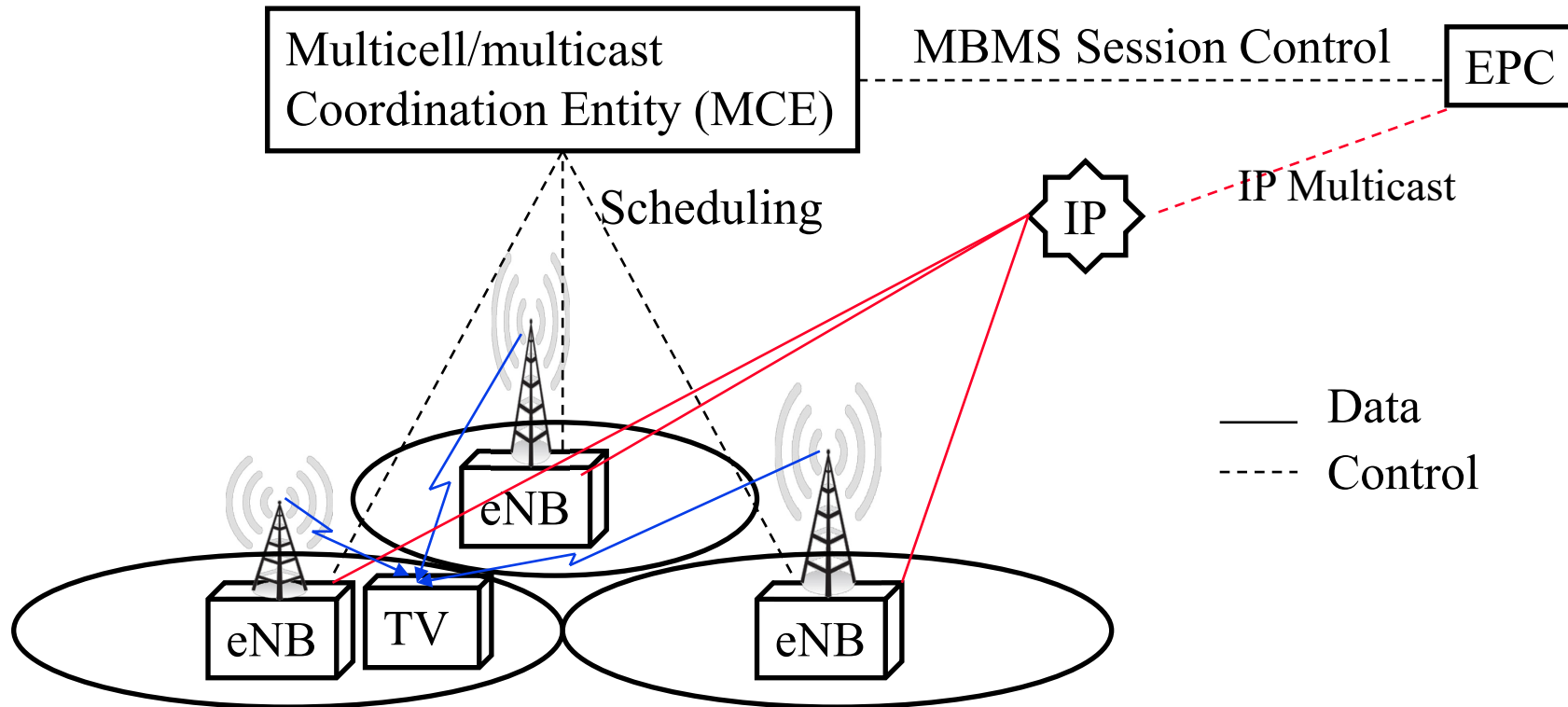

## Student Questions

# Voice over LTE (VoLTE)

- ❑ Original LTE is not circuit switched  
⇒ Voice needed to go through GSM or 3G circuits  
Called **Circuit Switch Fall Back (CSFB)** ⇒ Need dual radios
- ❑ **IP Multimedia Services (IMS)** handles the call setup signaling
- ❑ **Transmission Time Interval (TTI) bundling** allows to repeat the uplink transmission in 4 consecutive subframes ⇒ 4x power ⇒ Improves link budget by 6 dB ⇒ reduces block error rate
- ❑ **Semi-persistent scheduling** saves scheduling overhead.  
Cannot adopt continuously to changing channel conditions
- ❑ **Packet Bundling**: Send only when two voice packets

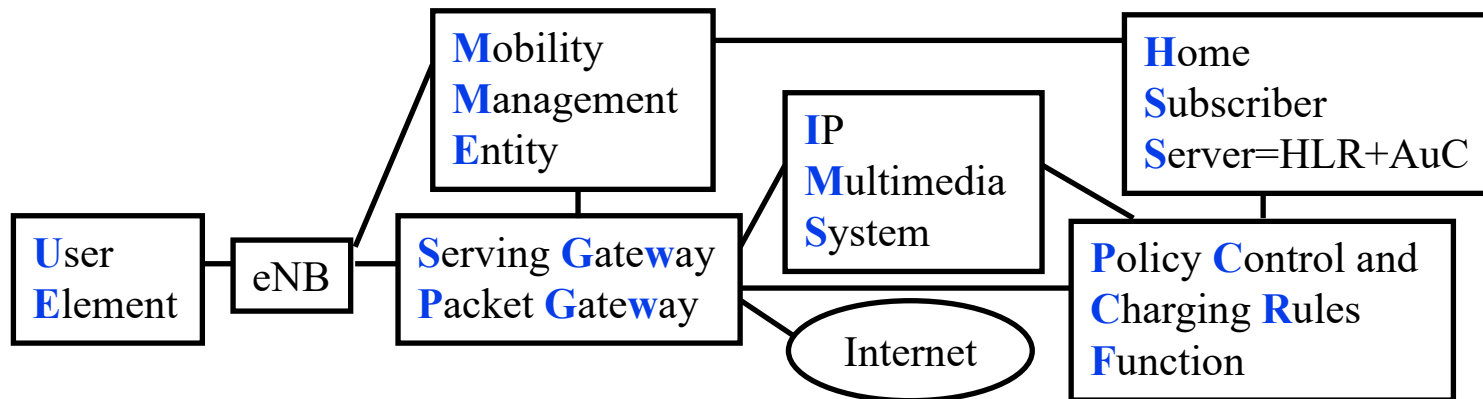

## Student Questions

# Enhancements in Release 12

1. Enhanced Small Cells
2. Device to Device Communication (D2D)
3. WLAN/3GPP Radio Interworking
4. HetNet Mobility Enhancements
5. Smart Congestion Mitigation (SCM)
6. Machine-Type Applications
7. FDD-TDD Carrier Integration
8. Dynamic TDD
9. Inter-eNB CoMP

Ref: Rohde & Schwarz GmbH & Co, "1MA252: LTE- Advanced (3GPP Rel.12) Technology Introduction White Paper,"

[https://www.rohde-schwarz.com/us/applications/lte-advanced-3gpp-rel.12-technology-introduction-white-paper-white-paper\\_230854-108294.html](https://www.rohde-schwarz.com/us/applications/lte-advanced-3gpp-rel.12-technology-introduction-white-paper-white-paper_230854-108294.html)

Washington University in St. Louis

<http://www.cse.wustl.edu/~jain/cse574-20/>

©2020 Raj Jain

## Student Questions



# Enhanced Small Cells

- **Higher order modulations:** Small cells  $\Rightarrow$  Higher SINR  
 $\Rightarrow$  Higher order modulations  $\Rightarrow$  256-QAM
- **Dual Connectivity:** Mobile can have two radios  
Mobile can connect to both macro and pico cells

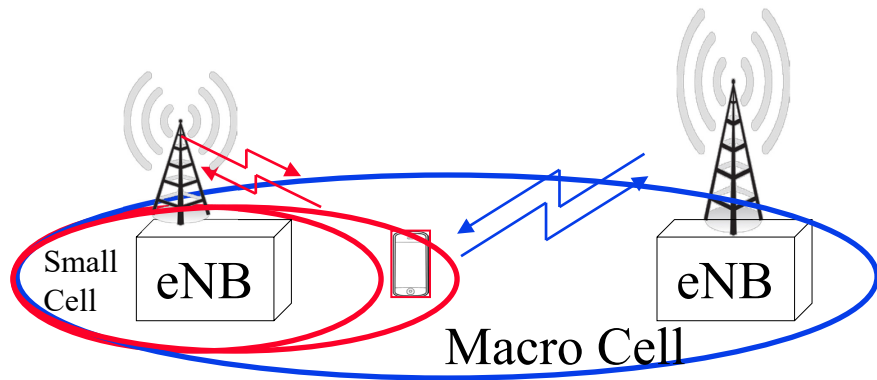

## Student Questions

# Device to Device Communication (D2D)

- ❑ In 2012, 10 MHz of paired spectrum in 700 MHz was set aside by FCC for use by first responders.
- ❑ 3GPP has extended LTE to allow direct communication between first responders even when there is no tower
- ❑ Others can also use this facility if at least one of them is connected to a tower
- ❑ Signaling to inform capability and discover other mobiles with similar capability has been developed.

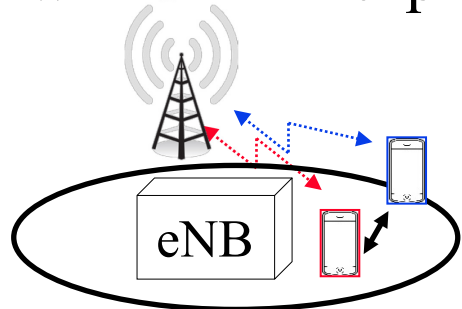

(a) Network Control

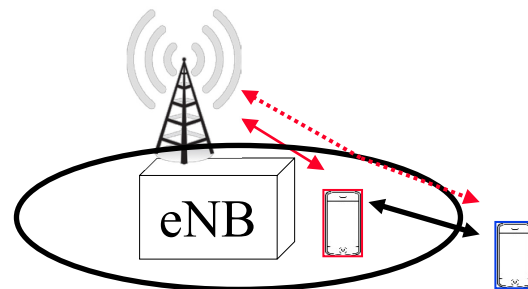

(b) D2D Relaying

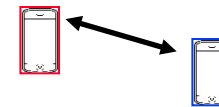

(c) Out-of-Coverage D2D  
(First Responders only)

## Student Questions

# WLAN/3GPP Radio Interworking

- ❑ If a mobile connected to LTE discovers a WLAN access point:
  - Carrier may want to move the traffic to WLAN APs that it owns
- ❑ **Access Network Discovery and Selection Function (ANDSF)** has been added in Release 12 to enable this. Helps decide which APs to join per carrier's preference and which traffic should be offloaded.
- ❑ User decides whether to turn WiFi on/off
- ❑ ANDSF function is present in both AP and eNB decides
- ❑ Mobile may have built-in rules for carriers that have not yet implemented ANDSF

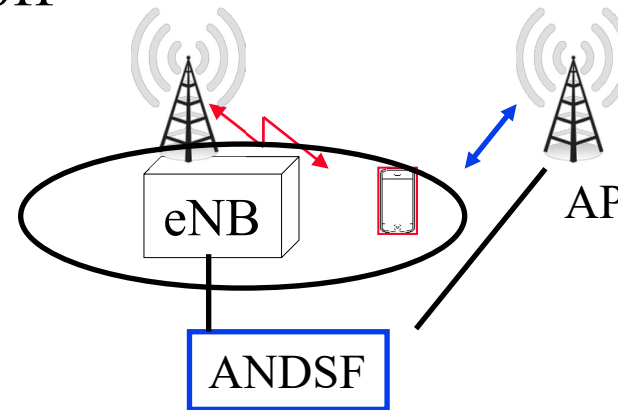

## Student Questions

# HetNet Mobility Enhancements

- ❑ Pico cells have small range  $\Rightarrow$  Mobiles may get in/out with not enough time to have seamless handover  $\Rightarrow$  Handover failures
- ❑ Depending upon the speed of the mobile and traffic type, eNB may decide not to handoff call to pico cell
- ❑ Mobile can start early recovery from handover failures using shortened recovery timers.

## Student Questions

# Smart Congestion Mitigation (SCM)

- ❑ Too many mobiles at a sport event  $\Rightarrow$  overload
- ❑ Better to prioritise traffic rather than deny all services
- ❑ Voice traffic is allowed but data traffic is not allowed for all users

## Student Questions

# Machine-Type Applications

- ❑ Three types of IoT:
  - Cameras: High UL traffic, no mobility
  - Fleet tracking: Low traffic, high mobility
  - Meter reading: Very low traffic, no mobility
- ❑ Signaling Overhead Reduction
  - Reduce signaling overhead for devices with infrequent data transfer
  - Expected UE behavior is communicated to eNB indicating expected activity time, idle time, and activity behavior
- ❑ Power consumption optimization
  - Meters may be using battery
  - Power saving mode allows them to sleep for long time

## Student Questions

# FDD-TDD Carrier Integration

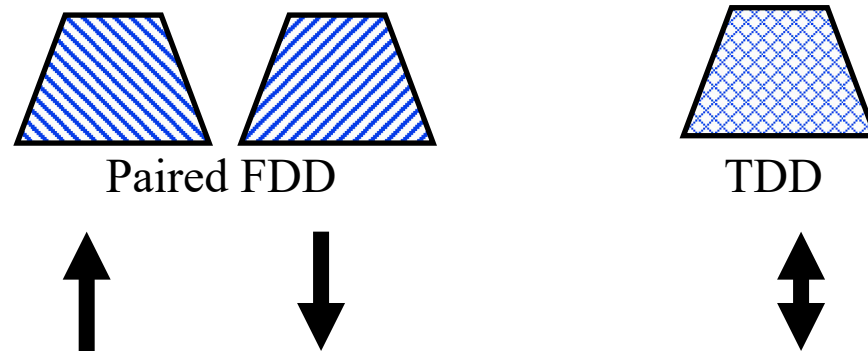

- ❑ Can aggregate Down FDD band with TDD in downlink
- ❑ Aggregate Up FDD band with TDD in uplink
- ❑ Use only FDD in Primary Cell and TDD in Small Cell or vice versa
- ❑ Generally FDD bands are lower frequency  $\Rightarrow$  Used for primary
- ❑ In future, 32 carriers could be aggregated

## Student Questions

# Dynamic TDD

- ❑ Time Division Duplexing (TDD) allows varying uplink to downlink ratio
- ❑ All cells in an area must synchronize their UL/DL subframes pattern, otherwise mobile's transmission get interference from neighboring BS
- ❑ LTE allows 7 variations of UL/DL subframe patterns.  
S=Switchover time from D to U

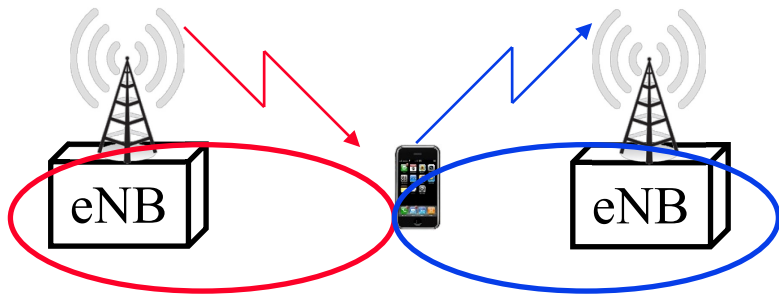

TDD Conf	TTI index									
	0	1	2	3	4	5	6	7	8	9
0	D	S	U	U	U	D	S	U	U	U
1	D	S	U	U	D	D	S	U	U	D
2	D	S	U	D	D	D	S	U	D	D
3	D	S	U	U	U	D	D	D	D	D
4	D	S	U	U	D	D	D	D	D	D
5	D	S	U	D	D	D	D	D	D	D
6	D	S	U	U	U	D	S	U	U	D

Ref: V. Pauli, Y. Li, E. Seidel, "Dynamic TDD for LTE-A and 5G," Nomor Research GmbH, Sep 2015, 8 pp.,

[http://nashville.dyndns.org:823/YourFreeLibrary/\\_lte/LTE%20advanced/WhitePaperNomor\\_LTE-A\\_5G-eIMTA\\_2015-09.pdf](http://nashville.dyndns.org:823/YourFreeLibrary/_lte/LTE%20advanced/WhitePaperNomor_LTE-A_5G-eIMTA_2015-09.pdf)

## Student Questions



# Dynamic TDD (Cont)

- ❑ Too many U's or D's in a row delay acks/nacks and affect the usefulness of HARQ.
- ❑ Release 12 added flexible "F" subframes that can be declared as S, D, or U  $\Rightarrow$  Can change every 10 ms.
- ❑ **Enhanced Interference Mitigation and Traffic Adaptation (eIMTA):** Cells can change UL/DL pattern as needed. Mobiles asked to transmit at higher power if needed.
- ❑ This will be further enhanced for 5G

TTI index									
0	1	2	3	4	5	6	7	8	9
D	S	U	F	F	D	S/D	F	F	F

## Student Questions

# Inter-eNB CoMP

- ❑ CoMP in Release 11 was restricted to eNBs connected via ideal backhaul  $\Rightarrow$  No need for network interfaces
- ❑ In Release 12, a signaling interface has been added which allows eNBs to interchange measurement and resource allocation information

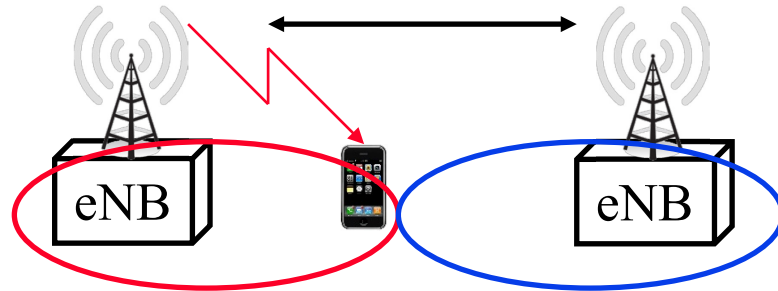

## Student Questions

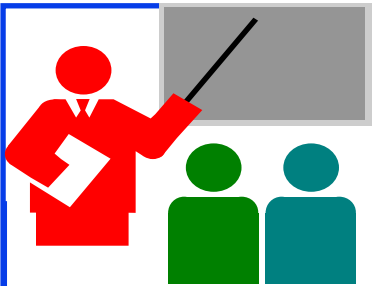

## Summary

1. LTE-A meets and exceeds all requirements for 4G as specified in IMT-Advanced.
2. Three key factors that affect data rate are: spectrum, spectral efficiency, and cell size
3. LTE-A can aggregate up to 5 carriers to make up to 100 MHz
4. LTE-A has frequency reuse factor of 1 since spectrum is expensive, uses high-order MIMO.
5. LTE-A uses relay nodes to cover remote areas and hot-spots. Also allows Home eNB (Femto cells).
6. Code-book and non-code book precoding improves MIMO
7. Coordinated Multipoint operation (CoMP) allows mitigation of interference at cell edge. CoMP can also be used with cross-carrier scheduling.

## Student Questions

# Reading List

- ❑ 3GPP, “LTE-Advanced,”  
<http://www.3gpp.org/technologies/keywords-acronyms/97-lte-advanced>
- ❑ Rohde & Schwarz GmbH & Co, “1MA252: LTE- Advanced (3GPP Rel.12) Technology Introduction White Paper,”  
[https://www.rohde-schwarz.com/us/applications/lte-advanced-3gpp-rel.12-technology-introduction-white-paper-white-paper\\_230854-108294.html](https://www.rohde-schwarz.com/us/applications/lte-advanced-3gpp-rel.12-technology-introduction-white-paper-white-paper_230854-108294.html)
- ❑ 3GPP, “HetNet/Small Cells,” <http://www.3gpp.org/hetnet>
- ❑ 3GPP, “Heterogeneous Networks in LTE,”  
<http://www.3gpp.org/technologies/keywords-acronyms/1576-hetnet>
- ❑ 3GPP, “Carrier Aggregation Explained,”  
<http://www.3gpp.org/technologies/keywords-acronyms/101-carrier-aggregation-explained>

## Student Questions

# Wikipedia Links

- ❑ [https://en.wikipedia.org/wiki/LTE\\_Advanced](https://en.wikipedia.org/wiki/LTE_Advanced)
- ❑ <https://en.wikipedia.org/wiki/Femtocell>
- ❑ [https://en.wikipedia.org/wiki/Home\\_Node\\_B](https://en.wikipedia.org/wiki/Home_Node_B)
- ❑ [https://en.wikipedia.org/wiki/Self-organizing\\_network](https://en.wikipedia.org/wiki/Self-organizing_network)
- ❑ [https://en.wikipedia.org/wiki/Voice\\_over\\_LTE](https://en.wikipedia.org/wiki/Voice_over_LTE)

## Student Questions

# LTE-Advanced Books

- ❑ S. Ahmadi, "LTE-Advanced," Academic Press, 2013, ISBN: 9780124051621, 1152 pp. Safari book.
- ❑ E. Dahlman, S. Parkvall, J. Skold, "4G: LTE/LTE-Advanced for Mobile Broadband, 2nd Edition," Academic Press, 2013, ISBN: 9780124199859, 544 pp. Safari book.
- ❑ C. Cox, "An Introduction to LTE: LTE, LTE-Advanced, SAE and 4G Mobile Communications, 2<sup>nd</sup> Edition" Wiley, 2014, ISBN: 9781118818039, 486 pp. Safari book.
- ❑ A. Ghosh, R. Ratasuk, "Essentials of LTE and LTE-A," Cambridge University Press, 2011, ISBN: 9780521768702, 264 pp. Safari book.
- ❑ A. Ghosh, J. Zhang, J. G. Andrews, R. Muhamed, "Fundamentals of LTE," Prentice Hall, 2010, ISBN: 0137033117, 464 pp. Safari book.
- ❑ H. Holma, A. Toskala, "LTE Advanced: 3GPP Solution for IMT-Advanced," Wiley, 2012, ISBN: 9781119974055, 248 pp. Safari book.
- ❑ X. Zhang, X. Zhou, "LTE-Advanced Air Interface Technology," CRC Press, 2012, ISBN: 9781466501522, 528 pp. Safari book.
- ❑ A. Taha, H. Hassanein, N. Ali, "LTE, LTE-ADVANCED AND WiMAX: TOWARDS IMT-ADVANCED NETWORKS," Wiley, 2012, ISBN: 9780470745687, 303 pp. Safari book.

## Student Questions

# Small Cells - Books

- J. Zhang and G Roche, “Femtocells: Technologies and Deployment,” Wiley, 2010, ISBN:0470742983

## Student Questions

# LTE-Advanced Specifications

- ❑ TR 36.806 E-UTRA Relay architectures for E-UTRA (LTE-Advanced)
- ❑ TR 36.808 E-UTRA Carrier Aggregation; Base Station (BS) radio transmission and reception
- ❑ TR 36.814 E-UTRA Further advancements for E-UTRA physical layer aspects
- ❑ TR 36.815 Further Advancements for E-UTRA; LTE-Advanced feasibility studies in RAN WG4
- ❑ TR 36.817 E-UTRA Uplink multiple antenna transmission; Base Station (BS) radio transmission and reception
- ❑ TR 36.819 Coordinated multi-point operation for LTE physical layer aspects
- ❑ TR 36.823 E-UTRA Carrier Aggregation Enhancements; UE and BS radio transmission and reception
- ❑ TR 36.826 E-UTRA Relay radio transmission and reception
- ❑ TR 36.871 E-UTRA Downlink Multiple Input Multiple Output (MIMO) enhancement for LTE-Advanced
- ❑ TR 36.912 Feasibility study for Further Advancements for E-UTRA (LTE-Advanced)

## Student Questions



# LTE-Advanced Specifications (Cont)

- ❑ TR 36.913 Requirements for further advancements for E-UTRA (LTE-Advanced)
- ❑ TR 36.932 Scenarios and requirements for Small Cell Enhancements for E-UTRA and E-UTRAN
- ❑ TS 36.101 E-UTRA User Equipment (UE) radio transmission and reception
- ❑ TS 36.211 E-UTRA Physical channels and modulation
- ❑ TS 36.212 E-UTRA Multiplexing and channel coding
- ❑ TS 36.213 E-UTRA Physical layer procedures
- ❑ TS 36.216 E-UTRA Physical layer for relaying operation
- ❑ TS 36.221 E-UTRA Medium Access Control (MAC) protocol specification
- ❑ TS 36.300 Evolved Universal Terrestrial Radio Access (E-UTRA) and Evolved Universal Terrestrial Radio Access Network (E-UTRAN); Overall description; Stage 2
- ❑ TS 36.306 E-UTRA User Equipment (UE) radio access capabilities
- ❑ TS 36.331 E-UTRA Radio resource Control (RRC) protocol specification
- ❑ TS 36.423 Evolved Universal Terrestrial Radio Access Network (E-UTRAN); X2 Application Protocol (X2AP)

All available at <http://www.3gpp.org/>

## Student Questions

# Femtocell Specifications

- ❑ 3GPP Rel 8 specifies HNB (Home Node B) and HeNB (22.\*)
- ❑ Rel 9 includes an IMS (IP Multimedia Subsystem) capable HNB (23.\*)
- ❑ TS 22.220: Service Requirements for HNB and HeNB
- ❑ TR 23.830: Architecture aspects of HNB and H3NB
- ❑ TR 23.832: IMS aspects of architecture for HNB
- ❑ TR 25.820: 3G HNB study item
- ❑ TR 25.967: FDD HNB RF Requirements
- ❑ TR 32.821: Study of self-organizing networks related OAM interfaces for HNB  
TR33.820: Security of HNB/HeNB
- ❑ TS 25.467: Mobility procedures for HNB
- ❑ TS 25.468: UTRAN Iuh Interface RANAP (Radio Access Network Application Part)  
User adaptation signaling
- ❑ TS 25.469: UTRAN Iuh Interface HNB application part signaling
- ❑ TS 32.581: HNB OAM&P (Operation, Administration, Management and Provisioning) concepts and requirements for Type 1 interface HNT to HNT  
Management system

## Student Questions

# Femtocell Specifications (Cont)

- ❑ TS 32.582: HNB OAM&P information model for Type 1 interface HNT to HNT Management system
- ❑ TS 32.583: HNB OAM&P procedure flows for Type 1 interface HNT to HNT Management system
- ❑ Broadband Forum TR-069 management protocol has been adopted to include femtocells.

## Student Questions

# LTE-Advanced References

- ❑ ITU-R Report M.2134, “Requirements Related to Technical Performance for IMT-Advanced Radio Interface(s),” November 2008.
- ❑ 4G LTE News, 4G LTE Forum, LTE-Advanced and more, <http://www.lteportal.com/MediaChannel/Articles/>
- ❑ Rohde & Schwarz, “1MA232: LTE-Advanced (3GPP Rel. 11) Technology Introduction,” [https://www.rohde-schwarz.com/en/applications/lte-advanced-3gpp-rel.11-technology-introduction-application-note\\_56280-42753.html](https://www.rohde-schwarz.com/en/applications/lte-advanced-3gpp-rel.11-technology-introduction-application-note_56280-42753.html)

## Student Questions

# Acronyms

- ❑ 3GPP      3rd Generation Partnership Project
- ❑ ABS      Almost Blank Subframes
- ❑ ANDSF    Access Network Discovery and Selection Function
- ❑ AP        Access Point
- ❑ BS        Base Station
- ❑ CoMP     Coordinated Multipoint Operation
- ❑ CRE      Cell Range Extension
- ❑ CRS      Cell Reference Signals
- ❑ CSFB     Circuit Switch Fall Back
- ❑ dBm      deciBel miliwatt
- ❑ DeNB     Donor eNB
- ❑ DFT      Discrete Fourier Transform
- ❑ DL        Down Link
- ❑ DM-RS    Demodulation Reference Signal
- ❑ DSL      Digital Subscriber Line
- ❑ eICIC     Enhanced Inter-Cell Interference Cancellation

## Student Questions

# Acronyms (Cont)

- ❑ eNode-B      Enhanced Node Basestation
- ❑ eNB          eNode B
- ❑ EPC          Evolved Packet Core
- ❑ FDD          Frequency Division Duplexing
- ❑ FCC          Federal Communications Commission
- ❑ FDMA        Frequency Division Multiple Access
- ❑ GPS          Global Positioning System
- ❑ GSM          Global System for Mobile Communication
- ❑ HARQ        Hybrid Automatic Repeat Request
- ❑ HD          High Definition
- ❑ HeNB        Home eNB
- ❑ HetNet      Heterogeneous Network
- ❑ HSS          Home Subscriber System
- ❑ ID          Identifier
- ❑ IDFT        Inverse Discrete Fourier Transform
- ❑ IEEE        Institution of Electrical and Electronic Engineers

## Student Questions

# Acronyms (Cont)

- ❑ IMS Internet Multimedia System
- ❑ IMT-Advanced International Mobile Telecommunications Advanced
- ❑ IP Internet Protocol
- ❑ ITU International Telecommunications Union
- ❑ LAN Local Area Network
- ❑ LTE-Advanced Long-Term Evolution Advanced
- ❑ LTE Long-Term Evolution
- ❑ MAC Media Access Control
- ❑ MBMS Multimedia Broadcast Multicast Service
- ❑ MBSFN MBMS Single Frequency Network
- ❑ MCE Multicast Coordination Entity
- ❑ MHz Mega Hertz
- ❑ MIMO Multiple Input Multiple Output
- ❑ MU-MIMO Multi-User MIMO
- ❑ NTP Network Time Protocol
- ❑ OAM Operation, Administration, and Management

## Student Questions

## Acronyms (Cont)

- ❑ PDCCH Packet Data Control Channel
- ❑ PHY Physical Layer
- ❑ PRB Physical Resource Block
- ❑ RAN Radio Access Network
- ❑ RANAP Radio Access Network Application
- ❑ RF Radio Frequency
- ❑ RLC Radio Link Control
- ❑ RN Relay Node
- ❑ RRC Radio Resource Control
- ❑ RRH Remote Radio Heads
- ❑ RS Reference Signal
- ❑ SAE Service Access Gateway
- ❑ SC-FDMA Single Carrier Frequency Division Multiple Access
- ❑ SFBC Space-Frequency Block Code
- ❑ SINR Signal to Interference and Noise Ratio
- ❑ SOHO Small Office Home Office

## Student Questions



# Acronyms (Cont)

- ❑ SON Self-Organizing Network
- ❑ SSDL Strongest Signal in Downlink
- ❑ SU-MIMO Single User MIMO
- ❑ TDD Time Division Duplexing
- ❑ TTI Transmission Time Interval
- ❑ TV Television
- ❑ UE User Element
- ❑ UL Uplink
- ❑ UMTS Universal Mobile Telecommunications System
- ❑ UTRA UMTS Terrestrial Radio Access
- ❑ UTRAN UMTS Terrestrial Radio Access Network
- ❑ VoLTE Voice over LTE
- ❑ WG Working Group
- ❑ WiFi Wireless Fidelity
- ❑ WiMAX Worldwide Interoperability for Microwave Access

## Student Questions

# LTE Cat-0 Devices

- ❑ Simple device category for IoT in Release 12.
  - Single Antenna
  - Reduced peak rate up to 1 Mbps
  - Half-Duplex  $\Rightarrow$  No duplex filter
- ❑ **Power Save Mode (PSM):**
  - Previously a device could be active or idle and keep its IP address
  - eNB sends paging message if data is received for devices not connected
  - PSM allows devices to keep IP address but stop listening to incoming paging requests for long durations

## Student Questions

# Cell On/Off Switching

- ❑ Under low load a cell or small cell can be turned off
- ❑ Off cells broadcast “Discovery reference signals (DRS)” periodically so that they can be turned on if necessary
- ❑ Takes a few hundred ms
- ❑ Used for energy consumption during nights

## Student Questions

**Scan This to Download These Slides**



Raj Jain

<http://rajjain.com>

[http://www.cse.wustl.edu/~jain/cse574-20/j\\_18lta.htm](http://www.cse.wustl.edu/~jain/cse574-20/j_18lta.htm)

**Student Questions**

# Related Modules



CSE567M: Computer Systems Analysis (Spring 2013),  
[https://www.youtube.com/playlist?list=PLjGG94etKypJEKjNAa1n\\_1X0bWWNyZcof](https://www.youtube.com/playlist?list=PLjGG94etKypJEKjNAa1n_1X0bWWNyZcof)

CSE473S: Introduction to Computer Networks (Fall 2011),  
[https://www.youtube.com/playlist?list=PLjGG94etKypJWOSPMh8Azcg5e\\_10TiDw](https://www.youtube.com/playlist?list=PLjGG94etKypJWOSPMh8Azcg5e_10TiDw)



Recent Advances in Networking (Spring 2013),  
<https://www.youtube.com/playlist?list=PLjGG94etKypLHyBN8mOgwJLHD2FFIMGq5>

CSE571S: Network Security (Fall 2011),  
<https://www.youtube.com/playlist?list=PLjGG94etKypKvzfVtutHcPFJXumyyg93u>



Video Podcasts of Prof. Raj Jain's Lectures,  
<https://www.youtube.com/channel/UCN4-5wzNP9-ruOzQMs-8NUw>

## Student Questions