

Wireless LANs

Part II: 802.11a/b/g/n/ac



Raj Jain

Professor of Computer Science and Engineering
Washington University in Saint Louis
Saint Louis, MO 63130
Jain@cse.wustl.edu

Audio/Video recordings of this class lecture are available at:

<http://www.cse.wustl.edu/~jain/cse574-20/>

Student Questions



1. IEEE 802.11 Amendments
2. Protocol Data Units (PDUs)
3. IEEE 802.11abgn
4. 802.11e: Enhanced DCF, Frame Bursting, Direct Link
5. IEEE 802.11n: STBC, Bonding, Aggregation
6. IEEE 802.11ac: Beamforming, Multi-User MIMO

Note: This is 2nd in a series of class lectures on Wireless LANs.

Student Questions

IEEE 802.11 Amendments

- ❑ **802.11a-1999**: Higher Speed PHY Extension in the 5 GHz Band
- ❑ **802.11b-1999**: Higher Speed PHY Extension in the 2.5 GHz Band
- ❑ **802.11c**: Bridge Operation (Added to IEEE 802.1D)
- ❑ **802.11d-2001**: Global Harmonization (PHYs for other countries.)
- ❑ **802.11e-2005**: Quality of Service.
- ❑ **802.11F**: Inter-Access Point Protocol (Withdrawn)
- ❑ **802.11g-2003**: Higher data rate extension in 2.4GHz band
- ❑ **802.11h-2003**: Dynamic Frequency Selection and transmit power control to satisfy 5GHz band operation in Europe.

Student Questions

IEEE 802.11 Amendments (Cont)

- ❑ **802.11i-2004**: MAC Enhancements for Enhanced Security.
- ❑ **802.11j-2004**: 4.9-5 GHz operation in Japan.
- ❑ **802.11k-2008**: Radio Resource Measurement interface to higher layers.
- ❑ **802.11m**: Maintenance. Correct editorial and technical issues in 802.11a/b/d/g/h.
- ❑ **802.11n-2009**: Enhancements for higher throughput (100+ Mbps)
- ❑ **802.11p-2010**: Inter-vehicle and vehicle-road side communication at 5.8GHz.
- ❑ **802.11r-2008**: Fast Roaming
- ❑ **802.11s-2011**: Extended Service Set (ESS) Mesh Networks.

Student Questions

IEEE 802.11 Amendments (Cont)

- ❑ 802.11T: Performance Metrics
- ❑ 802.11u-2011: Inter-working with External Networks.
- ❑ 802.11v-2011: Wireless Network Management enhancements for interface to upper layers. Extension to 802.11k.
- ❑ 802.11w-2009: Protected Management Frames
- ❑ 802.11y-2008: 2650-3700 MHz operation in USA
- ❑ 802.11z-2010: Direct Datalink Setup (DLS) mechanism w Power Save.
- ❑ 802.11aa-2012: Video Transport Streams
- ❑ 802.11ac-2013: Very High Throughput <6GHz
- ❑ 802.11ad-2012: Very High Throughput 60 GHz
- ❑ 802.11ae-2012: Prioritization of Management Frames

Ref: http://grouper.ieee.org/groups/802/11/Reports/802.11_Timelines.htm

Washington University in St. Louis

<http://www.cse.wustl.edu/~jain/cse574-20/>

©2020 Raj Jain

Student Questions

IEEE 802.11 Amendments (Cont)

- ❑ [802.11af-2013](#): TV Whitespaces.
- ❑ [IEEE Std P802.11-2016](#): Includes all amendments until 2015.
- ❑ [802.11ah-2017](#): Sub 1 GHz for IoT. OFDM PHY in license-exempt bands below 1 GHz, e.g., 868-868.6 MHz (Europe), 950 MHz -958 MHz (Japan), 314-316 MHz, 430-434 MHz, 470-510 MHz, and 779-787 MHz (China), 917 - 923.5 MHz (Korea) and 902-928 MHz (USA). Coexistence with IEEE 802.15.4 and IEEE P802.15.4g. Transmission range up to 1 km. Data rates > 100 kb/s.
- ❑ [P802.11ai-2016](#): Fast initial link set up. Fast AP detection, network discovery, association, authentication, and IP address assignment.

Student Questions

IEEE 802.11 Amendments (Cont)

- ❑ P802.11aj-2018: China millimeter wave. 59-64 GHz and 45 GHz.
- ❑ P802.11aq-2018: Pre-association discovery of services
- ❑ P802.11ak-2018: Enhancements for transit links within bridged networks. High-speed 802.11 links can be used as internal links just like Ethernet in addition to access.
- ❑ **P802.11ax**: High Efficiency WLAN. Extension of 802.11ac. Expected Dec 2019.
- ❑ **P802.11ay**: Next Generation 60 GHz. Extension of 802.11ad. Expected Dec 2019.
- ❑ P802.11az: Next generation positioning. Expected Mar 2021.
- ❑ P802.11ba: Wake Up Radio, Expected Sep 2020
- ❑ P802.11bb: Light Communications. 300 nm-5000nm band. 10 Mbps to 5 Gbps. Expected Jul 2021

Student Questions

ISO/OSI: Service Data Unit (SDU)

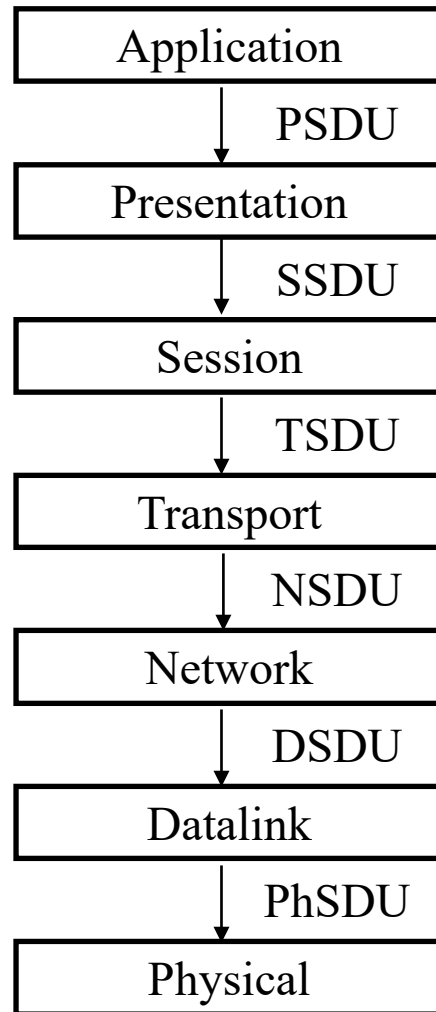

Student Questions

Protocol Data Unit (PDU)

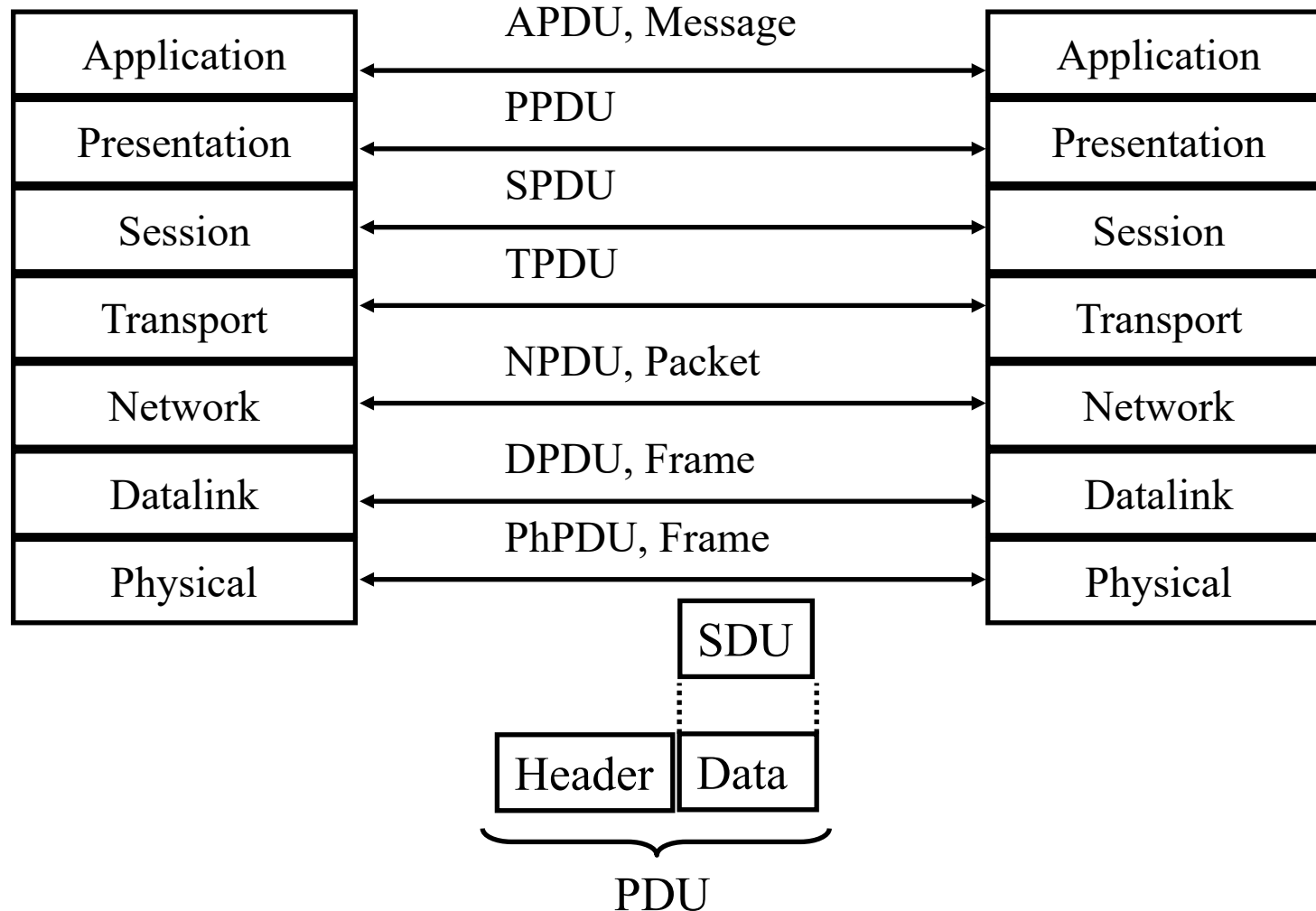

Student Questions

802.11 Protocol Layers

- ❑ **Logical Link Control (LLC)**: Bridging
- ❑ **Media Access Control (MAC)**: CSMA/CA, Ack
- ❑ **Physical Layer Convergence Procedure (PLCP)**: Framing
- ❑ **Physical Medium Dependent (PMD)**: Modulation

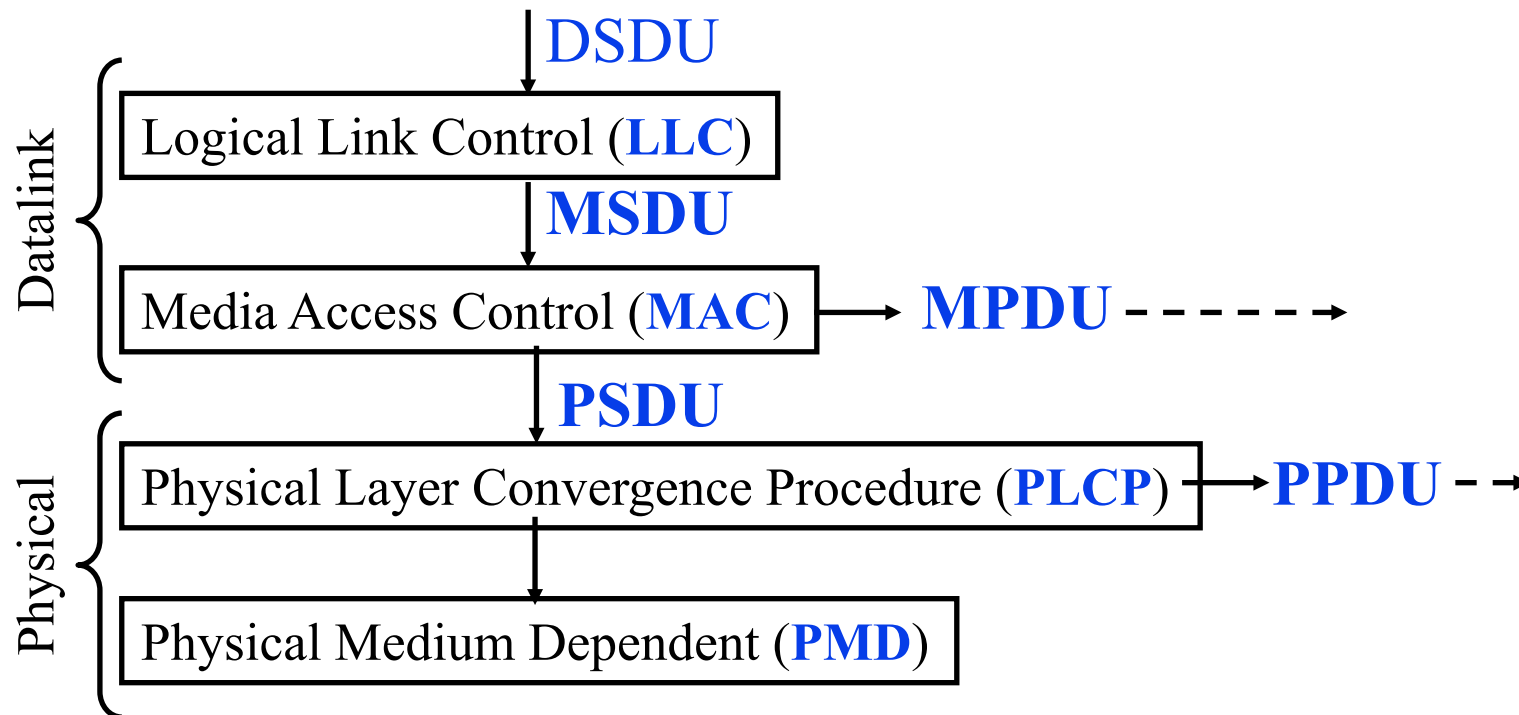

Student Questions

PLCP PDUs

- ❑ PMD includes scrambling (Randomization), coding (FEC), Interleaving, symbol mapping and modulation. For Example:

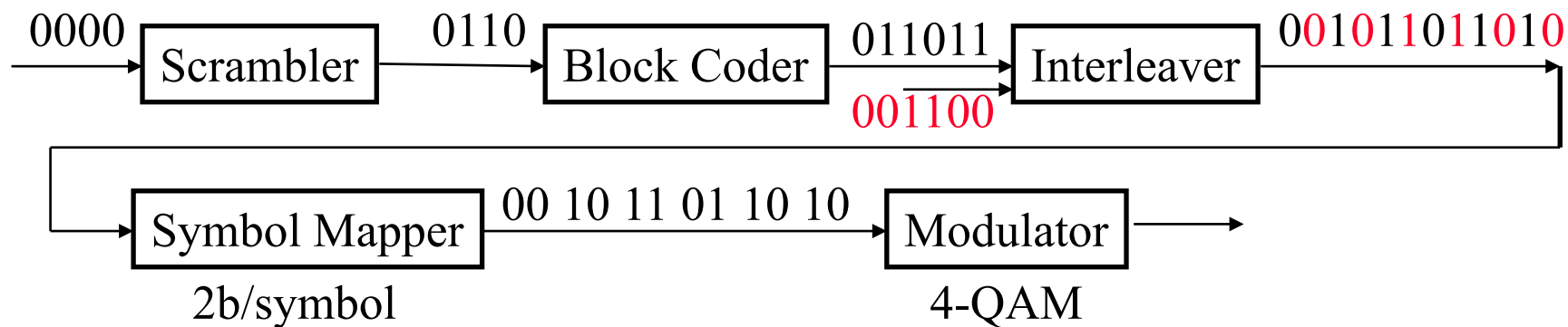

- ❑ PLCP adds a preamble and a header that helps receiving Phy to correctly decode the stream. For example:

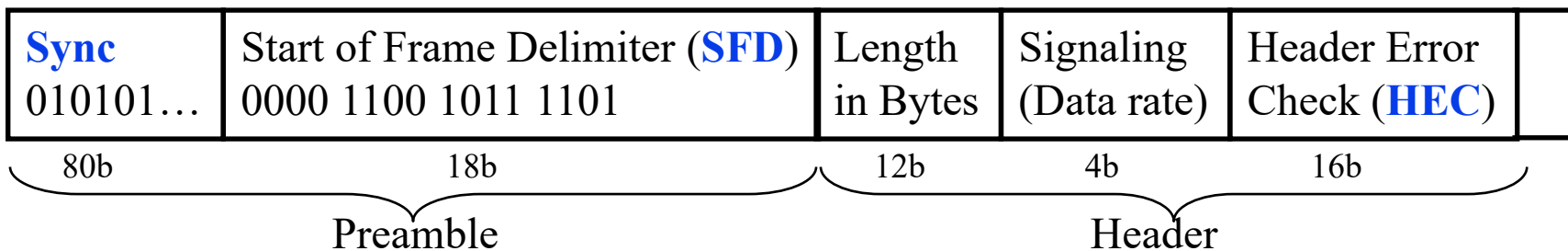

Ref: P. Roshan and J. Leary, "802.11 Wireless LAN Fundamentals," Cisco Press, 2003, ISBN:1587050773, Safari book

Washington University in St. Louis

<http://www.cse.wustl.edu/~jain/cse574-20/>

©2020 Raj Jain

Student Questions

IEEE 802.11b-1999

- ❑ Direct Sequence Spread Spectrum:

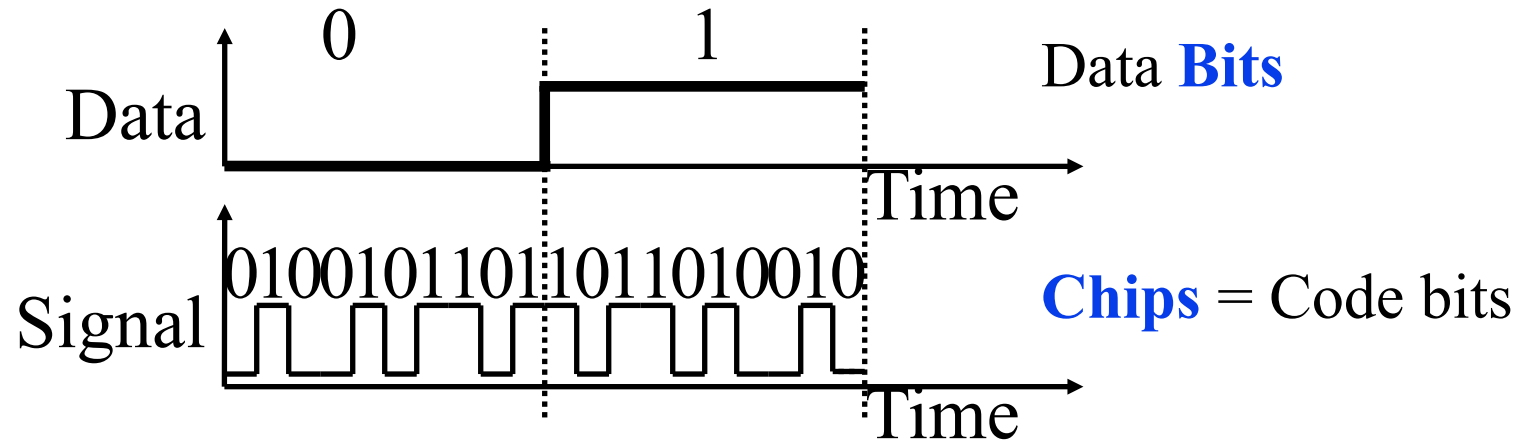

- ❑ **Complementary Code Keying (CCK):**
Multi-bit symbols with appropriate code to minimize errors
- ❑ IEEE 802.11-1997: $\frac{1}{2}$ rate binary convolution encoder, 1 bit/symbol, 11 chips/symbol, DQPSK (2 b/Hz) = $\frac{1}{2} \times 1 \times \frac{1}{11} \times 2 \times 22 = 2$ Mb/s using 22 MHz
- ❑ IEEE 802.11b-1999: $\frac{1}{2}$ rate binary convolution encoder, 8 bit/symbol, 8 chips/symbol, CCK (1 b/Hz) = $\frac{1}{2} \times 8 \times \frac{1}{8} \times 1 \times 22 = 11$ Mb/s using 22 MHz

Student Questions

IEEE802.11a-1999

- OFDM: 64 subcarriers in 20 MHz. 6 subcarriers at each end are used as guard (i.e., not used), 4 as pilots, leaving 48 for data \Rightarrow 12 MHz for data

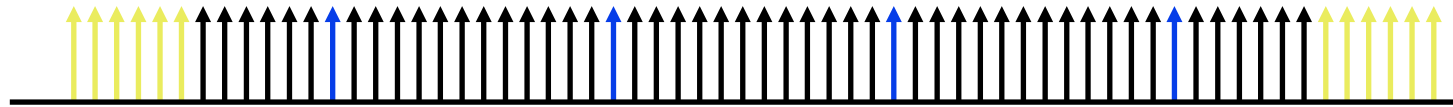

Coding	b/Hz	Mb/s	FEC	Net
BPSK	1	12	1/2	6 Mb/s
BPSK	1	12	3/4	9 Mb/s
QPSK	2	24	1/2	12 Mb/s
QPSK	2	24	3/4	18 Mb/s
16-QAM	4	48	1/2	24 Mb/s
16-QAM	4	48	3/4	36 Mb/s
64-QAM	6	72	2/3	48 Mb/s
64-QAM	6	72	3/4	54 Mb/s

- 5.4 GHz band \Rightarrow Expensive at that time

Student Questions

IEEE 802.11g-2003

- ❑ OFDM – Same as 802.11a \Rightarrow 54 Mbps
- ❑ 2.4 GHz band \Rightarrow Cheaper than 802.11a
- ❑ Fall back to 802.11b CCK

Student Questions

IEEE 802.11e-2005 (Enhanced QoS)

- ❑ Backward compatible:
 - ⇒ Non-802.11e terminals can receive QoS enabled streams
- 1. Hybrid Coordination Function (**HCF**) w two components
 - a. Contention Free Access: Hybrid Polling
 - b. Contention-based Access: Enhanced DCF (**EDCF**)
- 2. **Direct Link**: Traffic sent directly between two stations
- 3. **Frame bursting** and Group Acknowledge
- 4. Multiple **Priority** levels
- 5. Automatic Power Save Delivery

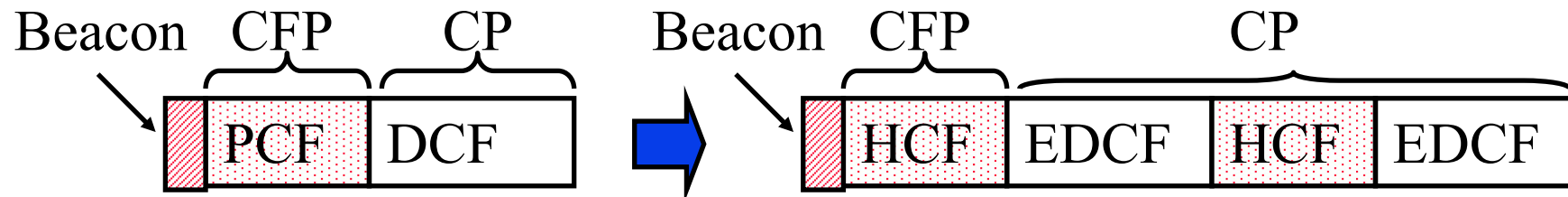

Student Questions

Enhanced DCF

- Up to 4 queues. Each Q gets a different set of four Parameters:
 - CW_{\min}/CW_{\max}
 - Arbitrated Inter-Frame Spacing (**AIFS**) = DIFS
 - Transmit Opportunity (**TXOP**) duration
- DIFS replaced by Arbitrated Inter-frame Spacing (AIFS)

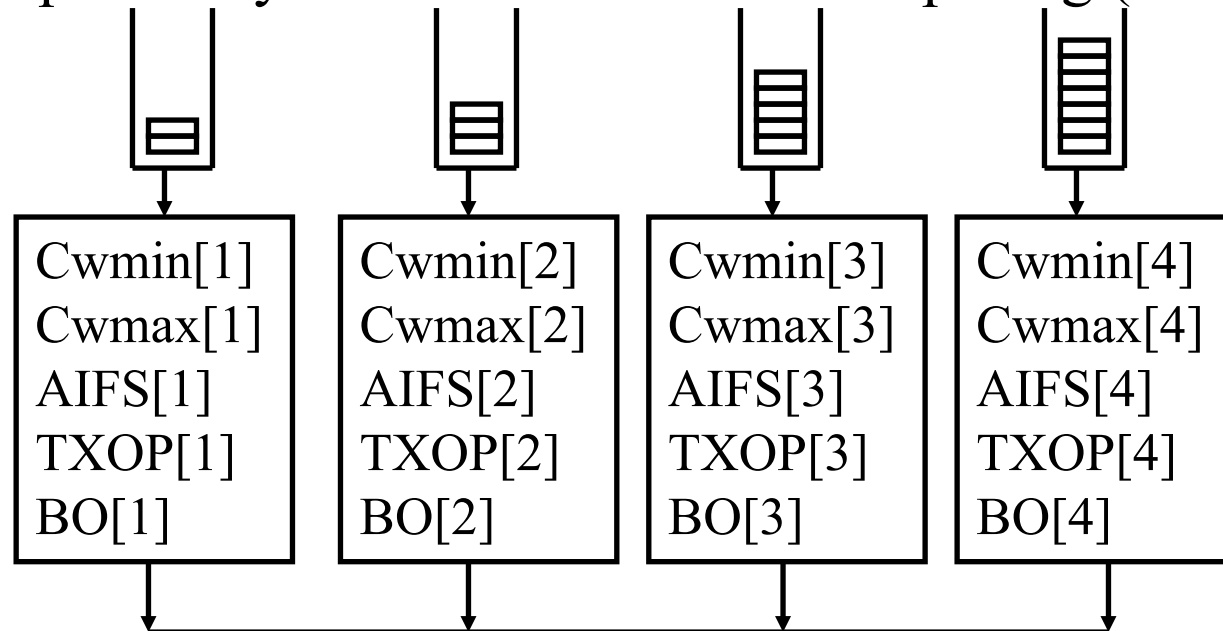

Student Questions

Frame Bursting

- ❑ EDCF parameters announced by access point in beacon frames
- ❑ Can not overbook higher priorities \Rightarrow Need admission control
- ❑ EDCF allows multiple frame transmission
- ❑ Max time = Transmission Opportunity (TXOP)
- ❑ Voice/gaming has high priority but small burst size
- ❑ Video/audio has lower priority but large burst size

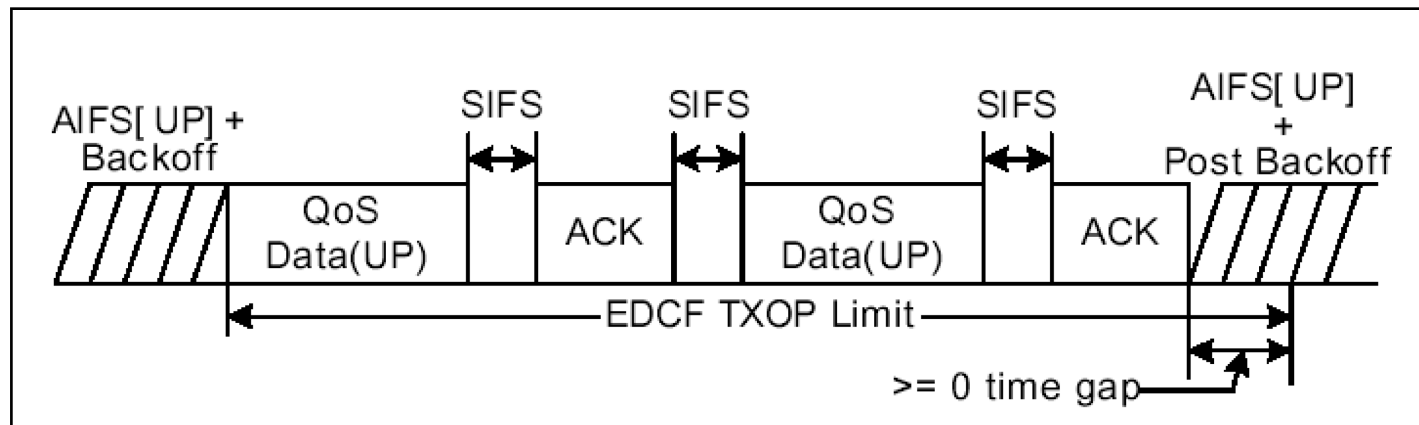

Student Questions

Direct Link

- Any station can transmit to any other station in the same BSS \Rightarrow No need to go through AP

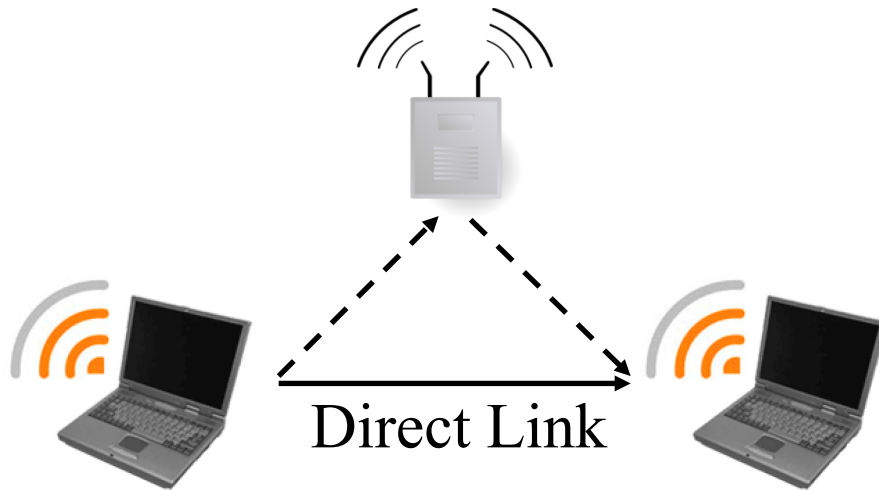

Student Questions

Automatic Power Save Delivery (APSD)

- ❑ Unscheduled APSD (U-APSD):
 - AP announces waiting frames in the beacon
 - When stations wake-up they listen to beacon.
 - Send a polling frame to AP.
 - AP sends frames.
- ❑ Scheduled APSD (S-APSD):
 - Station tells AP its wakeup schedule
 - AP sends frame on schedule. No need for polling.
- ❑ Pre-802.11e: AP announces in Beacon. STA polls. AP sends one frame with more bit. STA polls. AP sends next frame...

Student Questions

Homework 6A

Fill in the blanks:

1. 802.11a uses _____ in _____ GHz band.
2. 802.11b uses _____ in _____ GHz band.
3. 802.11g uses _____ in _____ GHz band.
4. 802.11n is a _____ band technology.
5. _____ specification deals with quality of service in 802.11 networks.
6. The key new concept that 802.11ac introduced is that of _____.
7. IP packets constitute _____ for 802.11 MAC layer without LLC.
8. MPDUs from MAC layer are used to form _____ and _____ in the PHY layer.
9. _____ is used to randomize bit stream before ECC coding.
10. _____ combines the bits from several symbols to overcome burst errors.
11. The code bits obtained by Direct Sequence Spread Spectrum are called _____.
12. IEEE 802.11e replaced DCF with _____ and PCF with _____.

Student Questions



IEEE 802.11n-2009

- MIMO** (Multi-input Multi-Output):
 $n \times m : k \Rightarrow n$ transmitters, m receivers, k streams
 k is the number parallel radio chains inside \leq # of Antennas
 $\Rightarrow k$ times more throughput
E.g., $2 \times 2 : 2$, $2 \times 3 : 2$, $3 \times 2 : 2$, $4 \times 4 : 4$
- Diversity**: More receive antennas than the number of streams.
Select the best subset of antennas.
- Beam Forming**: Focus the beam directly on the target antenna
- MIMO Power Save**: Use multiple antennas only when needed

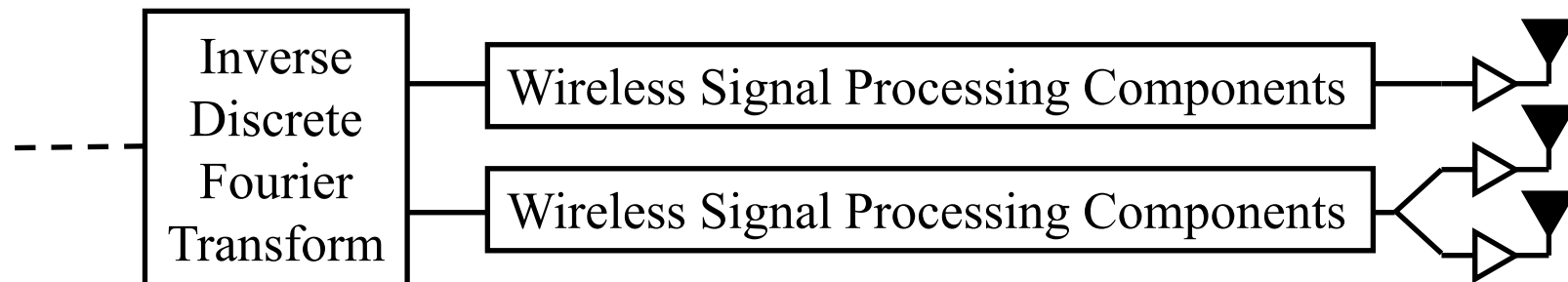

Student Questions

IEEE 802.11n-2009 (Cont)

5. **Frame Aggregation:** Pack multiple input frames in side a frame \Rightarrow Less overhead \Rightarrow More throughput
 6. **Lower FEC Overhead:** 5/6 instead of $\frac{3}{4}$
 7. **Reduced Guard Interval:** 400 ns instead of 800 ns
 8. **Reduced Inter-Frame Spacing** (SIFS=2 us, instead of 10 us)
 9. **Greenfield Mode:** Optionally eliminate support for a/b/g (shorter and higher rate preamble)
 10. **Dual Band:** 2.4 and 5.8 GHz
 11. **Space-Time Block Code**
 12. **Channel Bonding:** Use two adjacent 20 MHz channels
 13. **More subcarriers:** 52+4 instead of 48+4 with 20 MHz, 108+6 with 40MHz
- 54 Mbps with 64-QAM $\frac{3}{4}$ for 3200 Data+800 GI for a/g
- 4 Streams \times 64-QAM \times 5/6 FEC \times 40 MHz w 400 ns \Rightarrow 600 Mbps
- $$4 \times (6/6) \times [(5/6)/(3/4)] \times (108/48) \times [(3200+800)/(3200+400)] \times 54$$

Student Questions

Guard Interval

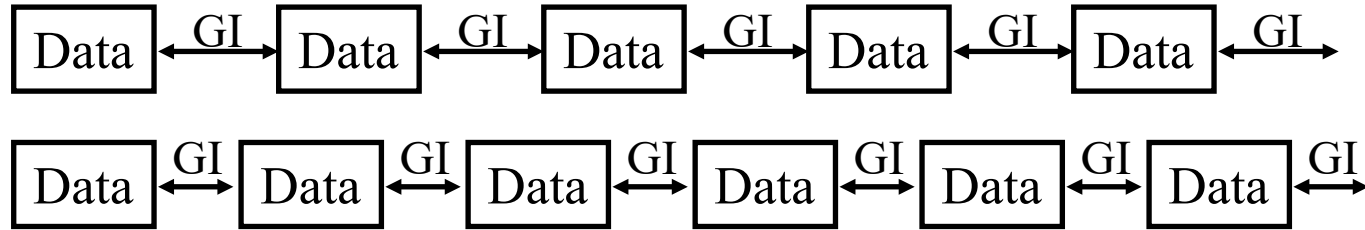

- ❑ Rule of Thumb: Guard Interval = $4 \times$ Multi-path delay spread
- ❑ Initial 802.11a design assumed 200ns delay spread
 $\Rightarrow 800$ ns GI + 3200 ns data $\Rightarrow 20\%$ overhead
- ❑ Most indoor environment have smaller 50-75 ns
- ❑ So if both sides agree, 400 ns can be used in 802.11n
 $\Rightarrow 400$ ns GI + 3200 ns data $\Rightarrow 11\%$ overhead

Student Questions

Space Time Block Codes (STBC)

- ❑ Invented 1998 by Vahid Tarokh.
- ❑ Transmit multiple redundant copies from multiple antennas
- ❑ Precisely coordinate distribution of symbols in space and time.
- ❑ Receiver combines multiple copies of the received signals optimally to overcome multipath.
- ❑ Example: Two antennas: Two symbols in two slots \Rightarrow Rate 1

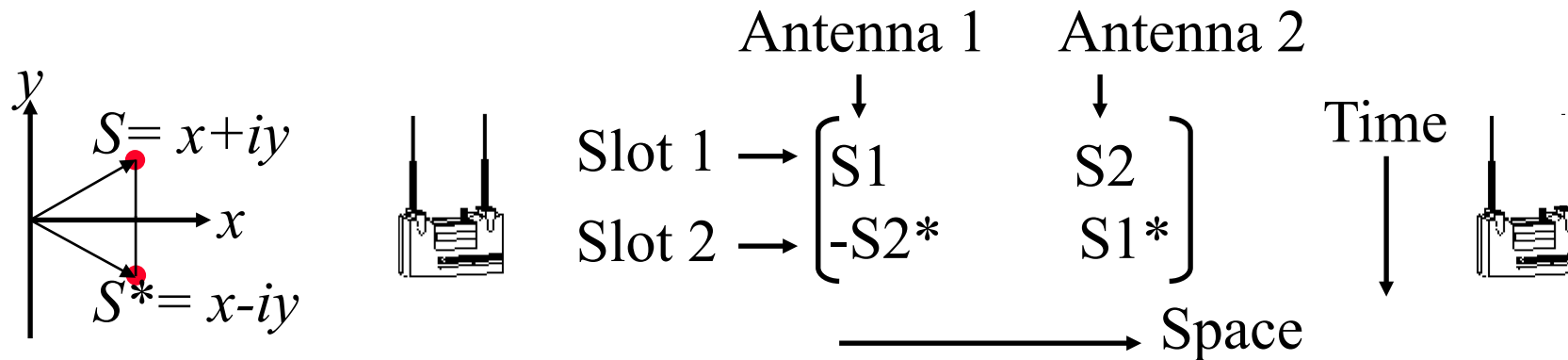

$S1^*$ is complex conjugate of $S1 \Rightarrow$ columns are orthogonal

Student Questions

802.11n Channel Bonding

- ❑ Two adjacent 20 MHz channels used
- ❑ OFDM: 52+4 instead of 48+4 with 20 MHz, 108+6 with 40MHz (No guard subcarriers between two bands)
- ❑ **Primary 20 MHz channel:** Used with stations not capable of channel bonding
- ❑ **Secondary 20 MHz channel:** Just below or just above primary.

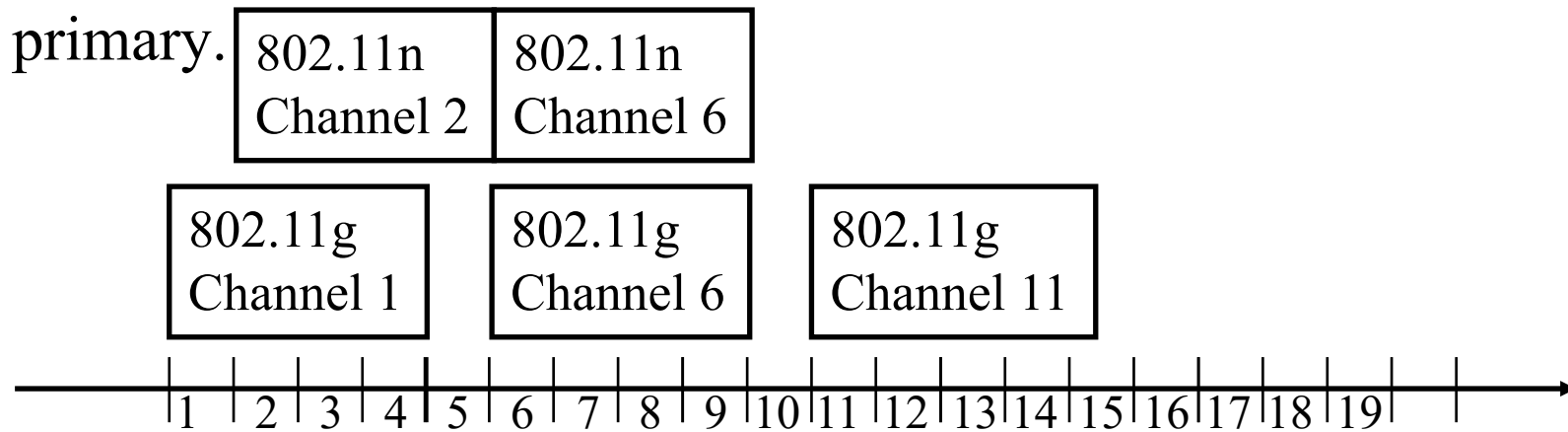

Student Questions

Ref: M. Gast, "802.11n: A Survival Guide," O'Reilly, 2012, ISBN:978-1449312046, Safari Book

Washington University in St. Louis

<http://www.cse.wustl.edu/~jain/cse574-20/>

©2020 Raj Jain

Frame Aggregation

- ❑ **Frame Bursting:** Transmit multiple PDUs together

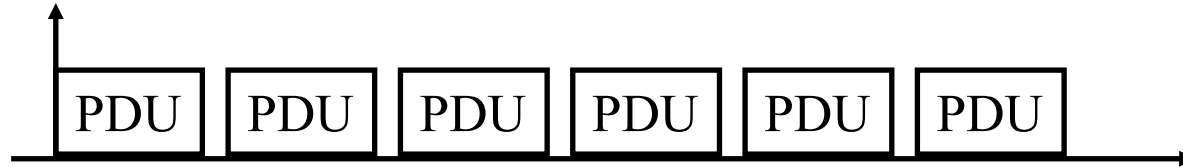

- ❑ **Frame Fragmentation:** SDU fragment in a PDU



- ❑ **Frame Aggregation:** Multiple SDUs in one PDU
All SDUs must have the same transmitter and receiver address

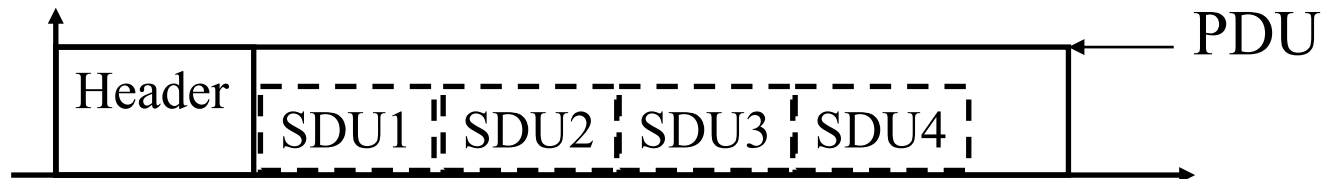

- ❑ Can combine any 2 or all of the above

Student Questions

802.11n Frame Aggregation

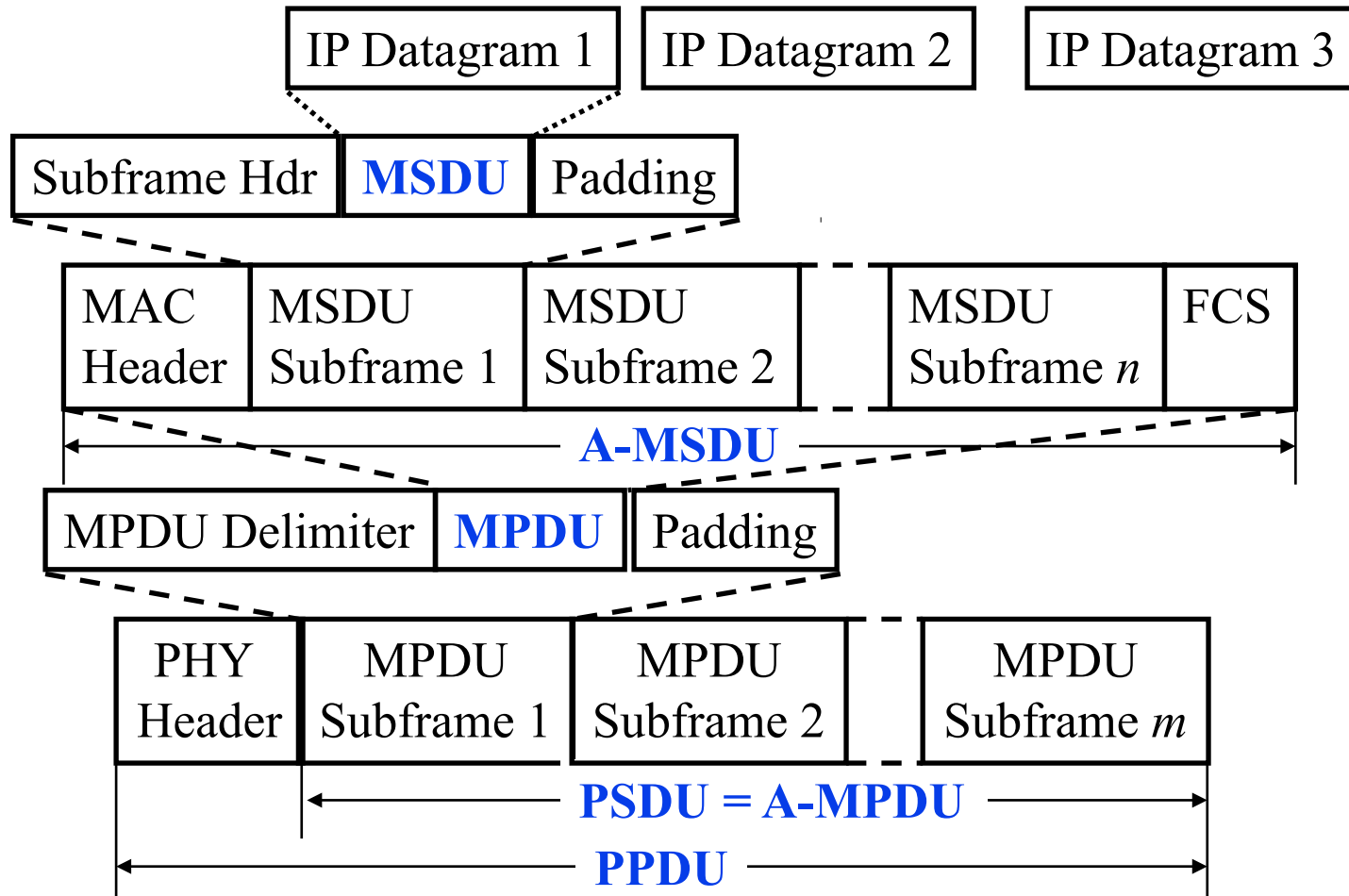

Student Questions

Ref: D. Skordoulis, et al., "IEEE 802.11n MAC Frame Aggregation Mechanisms for Next-Generation High-Throughput WLANs,"
IEEE Wireless Magazine, February 2008, <http://tinyurl.com/k2gv12g>

802.11n MAC Frame

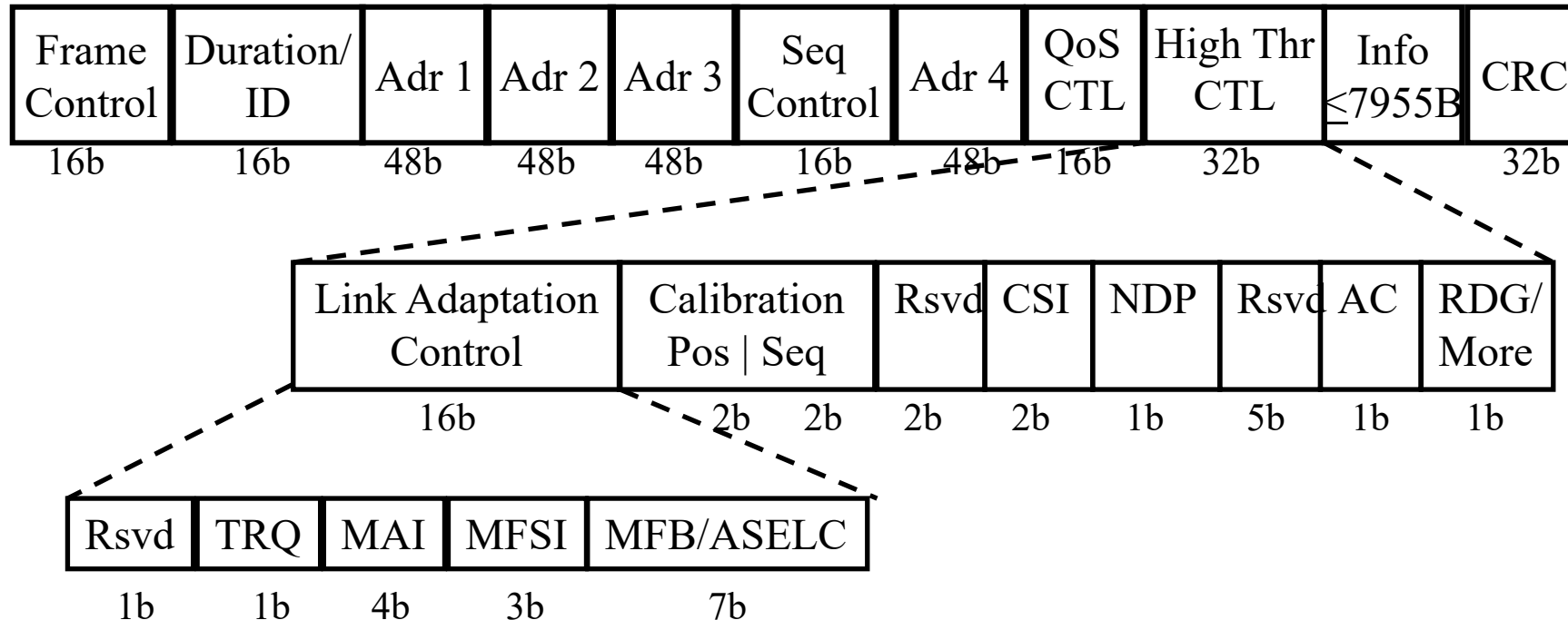

Student Questions

- ❑ For first RTS, SIFS is used in stead of DIFS.
Thus 11n stations have priority over 11abg
- ❑ 802.11n introduced a “High Throughput Control” field to exchange channel state information

IEEE 802.11ac

- ❑ Supports 80 MHz and 80+80 MHz channels
- ❑ 5 GHz only. No 2.4 GHz.
- ❑ 256-QAM 3/4 and 5/6: 8/6 times 64-QAM \Rightarrow 1.33X
- ❑ 8 Spatial streams: 2X
- ❑ **Multi-User MIMO**
- ❑ Null Data Packet (NDP) explicit beamforming only
- ❑ Less pilots: 52+4 (20 MHz), 108+6 (40 MHz), 234+8 (80 MHz), 468+16 (160 MHz). Note $468/52 = 9X$
- ❑ MAC enhancements for high-speed. HT Control field redefined
- ❑ 96.3 Mbps for 1 stream, 20 MHz, 256-QAM, 5/6, Short GI
- ❑ 8 streams and 160 MHz = $8 \times 9 \times 96.3 \text{ Mbps} = 6.9333 \text{ Gbps}$

Student Questions

Ref: M. Gast, "802.11ac: A Survival Guide," O'Reilly, July 2013, ISBN:978-1449343149, Safari Book

Beamforming

- ❑ Direct energy towards the receiver
- ❑ Requires an antenna array to alter direction per frame
⇒ A.k.a. Smart Antenna
- ❑ Implicit: Channel estimation using packet loss
- ❑ Explicit: Transmitter and receiver collaborate for channel estimation

Student Questions

Multi-User MIMO

- ❑ **MIMO**: Multiple uncorrelated spatial beams

Multiple antenna's separated by $\lambda/4$

Cannot put too many antennas on a small device

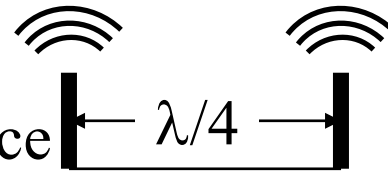

- ❑ **MU-MIMO**: Two single-antenna users can act as one multi-antenna device. The users do not really need to know each other.

- ❑ Simultaneous communication with two users on the same frequency at the same time.

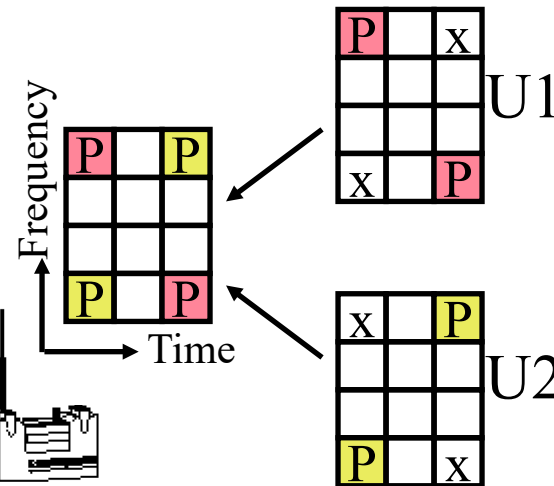
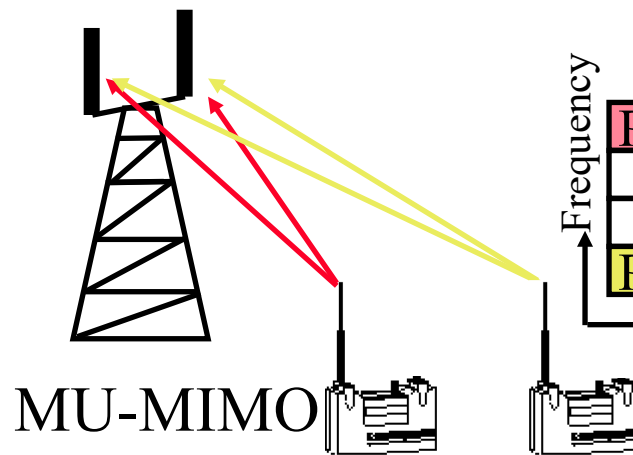
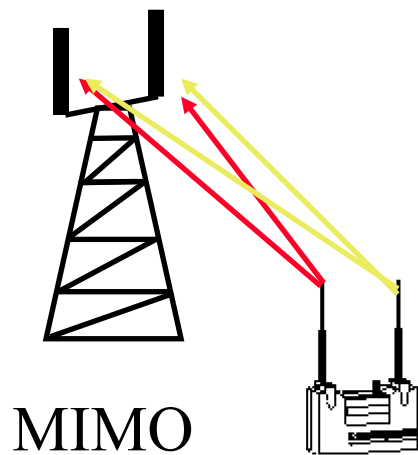

Student Questions

Beamforming with Multi-User MIMO

- ❑ **Single User MIMO:** Colors represent transmission signals not frequency.

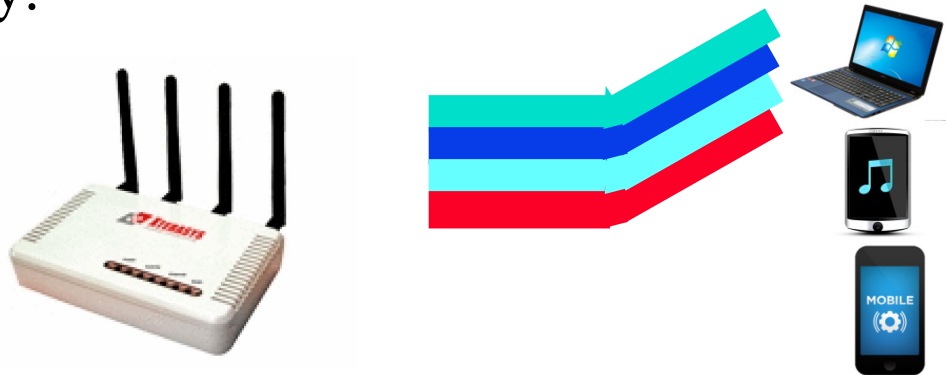

- ❑ **Multi User MIMO:**

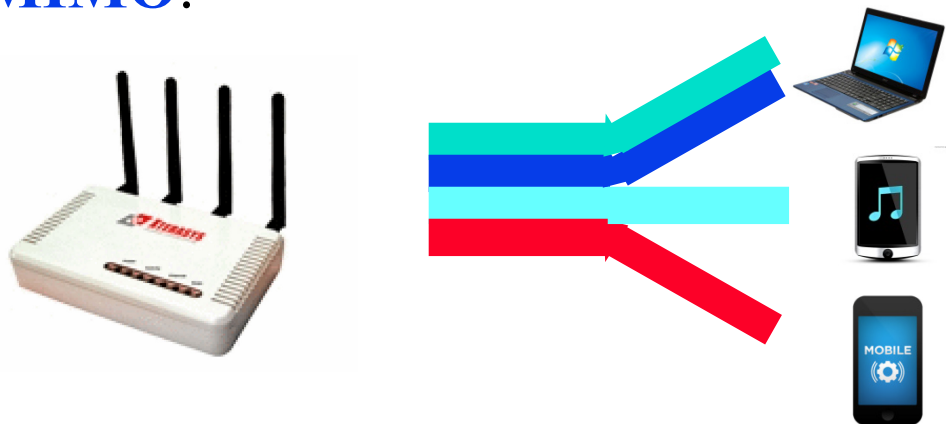

Student Questions

Primary and Non-Primary Channels

- ❑ Beacons on primary channel
- ❑ AP supports a mixture of single-band and multi-band stations
 ⇒ AP can change channel width on a frame by frame basis
- ❑ Stations need 160 MHz only some time
 ⇒ Two networks can share the same 160 MHz (e.g., AP2 and AP3 below)
- ❑ Stations check that entire bandwidth is available before using it

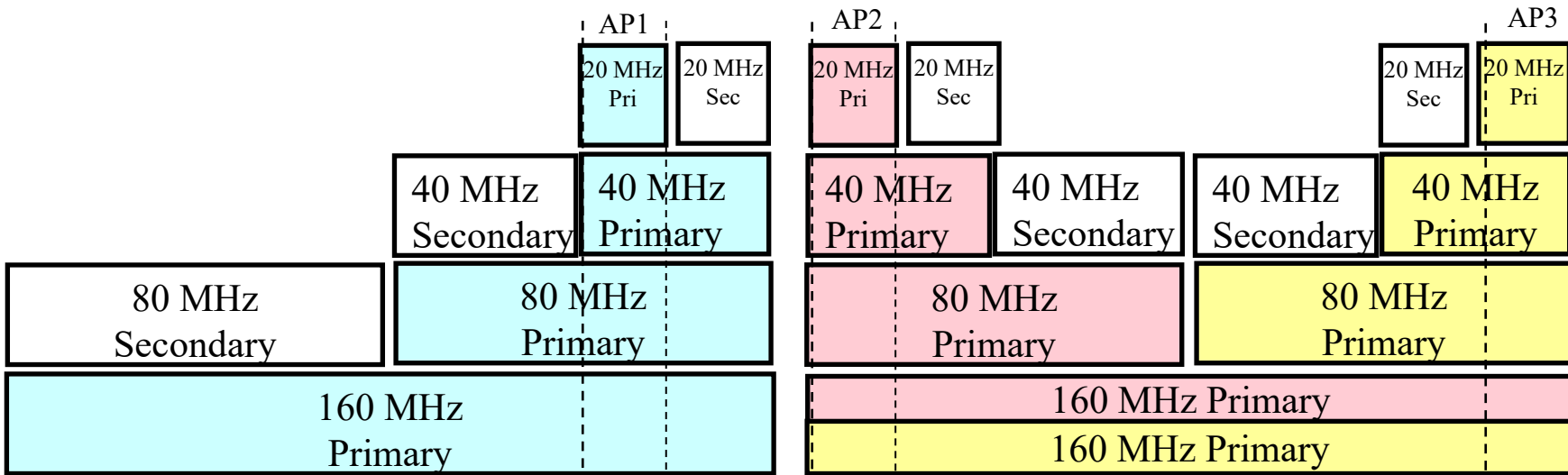

Student Questions

Summary

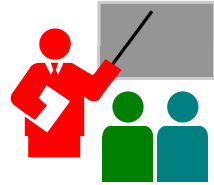

1. Each layer has SDU, PDU which can be Aggregated, Fragmented or transmitted in Burst.
2. 802.11a/g use OFDM with 64 subcarriers in 20 MHz. 48 Data, 4 Pilot, 12 guard.
3. 802.11e adds frame bursting, direct link, APSD, and 4 queues with different AIFS and TXOP durations. QoS field in frames.
4. 802.11n adds MIMO, aggregation, dual band, STBC, and channel bonding. HT Control field in frames.
5. IEEE 802.11ac supports multi-user MIMO with 80+80 MHz channels with 256-QAM and 8 streams to give 6.9 Gbps
6. Multi-User MIMO allows several users to be combined in a MIMO pool.

Student Questions

Homework 6B

- A. Given that 802.11ac Phy rate for 20MHz BPSK 1/2 channel with short GI is 7.22 Mbps, compute what would be the rate for 160 MHz 256-QAM $\frac{3}{4}$ with short GI? In both cases the number of streams is 8.

Student Questions

Reading List

1. M. Gast, "802.11n: A Survival Guide," O'Reilly, 2012, ISBN:978-1449312046, Safari Book
2. M. Gast, "802.11ac: A Survival Guide," O'Reilly, July 2013, ISBN:978-1449343149, Safari Book
3. P. Roshan and J. Leary, "802.11 Wireless LAN Fundamentals," Cisco Press, 2003, ISBN:1587050773, Safari book

Student Questions

Wikipedia Links

- ❑ http://en.wikipedia.org/wiki/IEEE_802.11
- ❑ http://en.wikipedia.org/wiki/IEEE_802.11a-1999
- ❑ http://en.wikipedia.org/wiki/IEEE_802.11b-1999
- ❑ http://en.wikipedia.org/wiki/IEEE_802.11e-2005
- ❑ http://en.wikipedia.org/wiki/IEEE_802.11g-2003
- ❑ http://en.wikipedia.org/wiki/IEEE_802.11n-2009
- ❑ http://en.wikipedia.org/wiki/Adaptive_beamformer
- ❑ <http://en.wikipedia.org/wiki/Beamforming>
- ❑ http://en.wikipedia.org/wiki/Channel_bonding
- ❑ http://en.wikipedia.org/wiki/Complementary_code_keying
- ❑ http://en.wikipedia.org/wiki/Cyclic_prefix
- ❑ http://en.wikipedia.org/wiki/DCF_Interframe_Space
- ❑ http://en.wikipedia.org/wiki/Forward_error_correction
- ❑ <http://en.wikipedia.org/wiki/Frame-bursting>
- ❑ http://en.wikipedia.org/wiki/Frame_aggregation

Student Questions

Wikipedia Links (Cont)

- ❑ http://en.wikipedia.org/wiki/Greenfield_project
- ❑ http://en.wikipedia.org/wiki/Guard_interval
- ❑ [http://en.wikipedia.org/wiki/IEEE_802.11_\(legacy_mode\)](http://en.wikipedia.org/wiki/IEEE_802.11_(legacy_mode))
- ❑ http://en.wikipedia.org/wiki/Low-density_parity-check_code
- ❑ <http://en.wikipedia.org/wiki/MIMO>
- ❑ <http://en.wikipedia.org/wiki/Precoding>
- ❑ http://en.wikipedia.org/wiki/Short_Interframe_Space
- ❑ http://en.wikipedia.org/wiki/Smart_antenna
- ❑ http://en.wikipedia.org/wiki/IEEE_802.11ac
- ❑ http://en.wikipedia.org/wiki/Spatial_multiplexing
- ❑ http://en.wikipedia.org/wiki/Multi-user_MIMO
- ❑ <http://en.wikipedia.org/wiki/STBC>

Student Questions

References

- ❑ D. Skordoulis, et al., "IEEE 802.11n MAC Frame Aggregation Mechanisms for Next-Generation High-Throughput WLANs," IEEE Wireless Magazine, February 2008, <http://tinyurl.com/k2gvl2g>
- ❑ http://grouper.ieee.org/groups/802/11/Reports/802.11_Timelines.htm
- ❑ Yang Xiao, "IEEE 802.11e QoS provisioning at the MAC layer", Volume: 11 Issue: 3, Pages: 72-79, IEEE Wireless Communications, 2004, <http://ieeexplore.ieee.org/iel5/7742/29047/01308952.pdf>
- ❑ Yang Xiao, "IEEE 802.11n enhancements for higher throughput in wireless LANs", Volume: 12, Issue: 6, Pages: 82-91, IEEE Wireless Communications, 2005, http://www.cs.mun.ca/~yzchen/papers/papers/mac/80211n_intro_xiao_j2005.pdf
- ❑ J. M. Gilbert, Won-Joon Choi and Qinfang Sun, "MIMO technology for advanced wireless local area networks", 42nd Design Automation Conference, 2005, pp. 413-415, <https://ieeexplore.ieee.org/document/1510364/>

Student Questions

References (Cont)

- ❑ IEEE 802.11e, “Medium Access Control Enhancements for Quality of Service”,
<http://people.cs.nctu.edu.tw/~yctseng/WirelessNet2010-02-nctu/ieee802-11e.ppt>
- ❑ Rohde & Schwarz, “IEEE 802.11n/IEEE 802.11ac Digital Standard for R&S Signal Generators: Operating Manual,”
http://www.rohde-schwarz.de/file/RS_SigGen_IEEE80211n_ac_Operating_en_16.pdf

Student Questions

Acronyms

- ❑ AC Access Point Constraint
- ❑ AIFS Arbitrated Inter-Frame Spacing
- ❑ AP Access Point
- ❑ AP Access Point
- ❑ APSD Automatic Power Save Delivery
- ❑ ASELC Antenna Selection Command/Data
- ❑ BCC Binary Convolution Code
- ❑ BO Backoff
- ❑ BPSK Binary Phase Shift Keying
- ❑ BSS Basic Service Set
- ❑ CCK Complementary Code Keying
- ❑ CFP Contention Free Period
- ❑ CP Contention Period
- ❑ CRC Cyclic Redundancy Check
- ❑ CSD Cyclic Shift Diversity
- ❑ CSI Channel State Information

Student Questions

Acronyms (Cont)

- ❑ CTL Control
- ❑ CTS Clear to send
- ❑ CW Contention Window
- ❑ CWmax Maximum Contention Window
- ❑ CWmin Minimum Contention Window
- ❑ DCF Distributed Coordination Function
- ❑ DIFS DCF Interframe Spacing
- ❑ DLS Direct Datalink Setup
- ❑ DQPSK Differential Quadrature Phase Shift Keying
- ❑ EDCA Enhanced Distributed Coordination Access
- ❑ EDCF Enhanced Distributed Coordination Function
- ❑ EOSP End of Service Period
- ❑ ESS Extended Service Set
- ❑ FCS Frame Check Sequence
- ❑ GHz Giga Hertz
- ❑ GI Guard Interval

Student Questions

Acronyms (Cont)

- ❑ HCF Hybrid Coordination Function
- ❑ HEC Header Error Check
- ❑ HT High Throughput
- ❑ ID Identifier
- ❑ IDFT Inverse Discrete Fourier Transform
- ❑ IEEE Institution of Electrical and Electronic Engineers
- ❑ IP Internet Protocol
- ❑ LAN Local Area Network
- ❑ LDPC Low Density Parity Check Code
- ❑ LLC Logical Link Control
- ❑ MAC Media Access Control
- ❑ MAI MCS Request/Antenna Selection Indication
- ❑ MCS Modulation and Coding Scheme
- ❑ MFB MCS Feedback
- ❑ MFS MFB Sequence Identifier
- ❑ MFSI MFB Sequence Identifier

Student Questions

Acronyms (Cont)

- ❑ MHz Mega Hertz
- ❑ MIMO Multiple Input Multiple Output
- ❑ MPDU MAC Protocol Data Unit
- ❑ MRQ MCS feedback request
- ❑ MRS MRQ Sequence Identifier
- ❑ MSDU MAC Service Data Unit
- ❑ MU-MIMO Multi-User MIMO
- ❑ NDP Null Data Packet
- ❑ OFDM Orthogonal Frequency Division Multiplexing
- ❑ PCF Point Coordination Function
- ❑ PDU Protocol Data Unit
- ❑ PHY Physical Layer
- ❑ PLCP Physical Layer Convergence Procedure
- ❑ PMD Physical Medium Dependent
- ❑ PPDU PLCP Protocol Data Unit
- ❑ PSDU PLCP Service Data Unit

Student Questions

Acronyms (Cont)

- ❑ QAM Quadrature Amplitude Modulation
- ❑ QoS Quality of Service
- ❑ QPSK Quadrature Phase Shift Keying
- ❑ RDG Reverse Direction Grant
- ❑ RIFS Reduced Inter-Frame Spacing
- ❑ S-APSD Scheduled Automatic Power Save Delivery
- ❑ SDU Service Data Unit
- ❑ SFD Start of Frame Delimiter
- ❑ SIFS Short Interframe Spacing
- ❑ STA Station
- ❑ STBC Space Time Block Code
- ❑ STBC Space Time Block Codes
- ❑ TID Traffic Identifier
- ❑ TRQ Training Request
- ❑ TV Television
- ❑ TXOP Transmission Opportunity

Student Questions

Acronyms (Cont)

- ❑ U-APSD Unscheduled Automatic Power Save Delivery
- ❑ VHT Very High Throughput
- ❑ WLANs Wireless Local Area Network

Student Questions

Scan This to Download These Slides



Raj Jain

rajjain.com/cse574-18

http://www.cse.wustl.edu/~jain/cse574-20/j_06lan.htm

Student Questions

Related Modules



CSE567M: Computer Systems Analysis (Spring 2013),
https://www.youtube.com/playlist?list=PLjGG94etKypJEKjNAa1n_1X0bWWNyZcof

CSE473S: Introduction to Computer Networks (Fall 2011),
https://www.youtube.com/playlist?list=PLjGG94etKypJWOSPMh8Azcg5e_10TiDw



Recent Advances in Networking (Spring 2013),

<https://www.youtube.com/playlist?list=PLjGG94etKypLHyBN8mOgwJLHD2FFIMGq5>

CSE571S: Network Security (Fall 2011),
<https://www.youtube.com/playlist?list=PLjGG94etKypKvzfVtutHcPFJXumyyg93u>



Video Podcasts of Prof. Raj Jain's Lectures,
<https://www.youtube.com/channel/UCN4-5wzNP9-ruOzQMs-8NUw>

Student Questions