

Introduction to Network Function Virtualization (NFV)

Raj Jain

Washington University in Saint Louis

Saint Louis, MO 63130

Jain@cse.wustl.edu

These slides and audio/video recordings of this class lecture are at:

<http://www.cse.wustl.edu/~jain/cse570-21/>

Student Questions



1. What is NFV?
2. NFV and SDN Relationship
3. ETSI NFV ISG Specifications
4. Concepts, Architecture, Requirements, Use cases
5. Proof-of-Concepts and Timeline

Note: This module is the 3rd in a series of modules on OpenFlow, SDN and NFV in this course.

Student Questions

Four Innovations of NFV

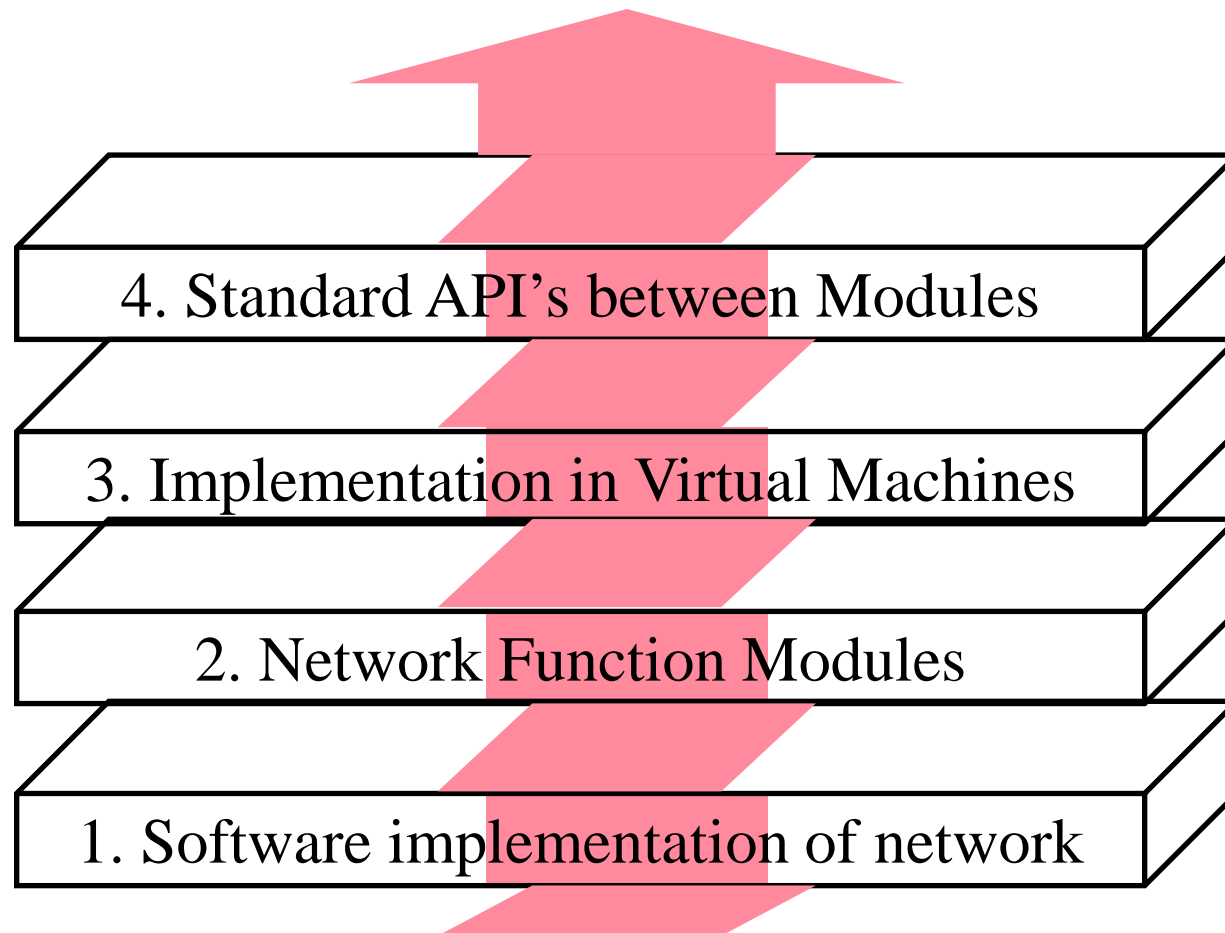

Student Questions

Network Function Virtualization (NFV)

1. Fast standard hardware \Rightarrow **Software based devices**

Routers, Firewalls, Broadband Remote Access Server (BRAS)
 \Rightarrow A.k.a. *white box* implementation

2. **Function Modules** (Both data plane and control plane)

\Rightarrow DHCP (Dynamic Host control Protocol), NAT (Network Address Translation), Rate Limiting,

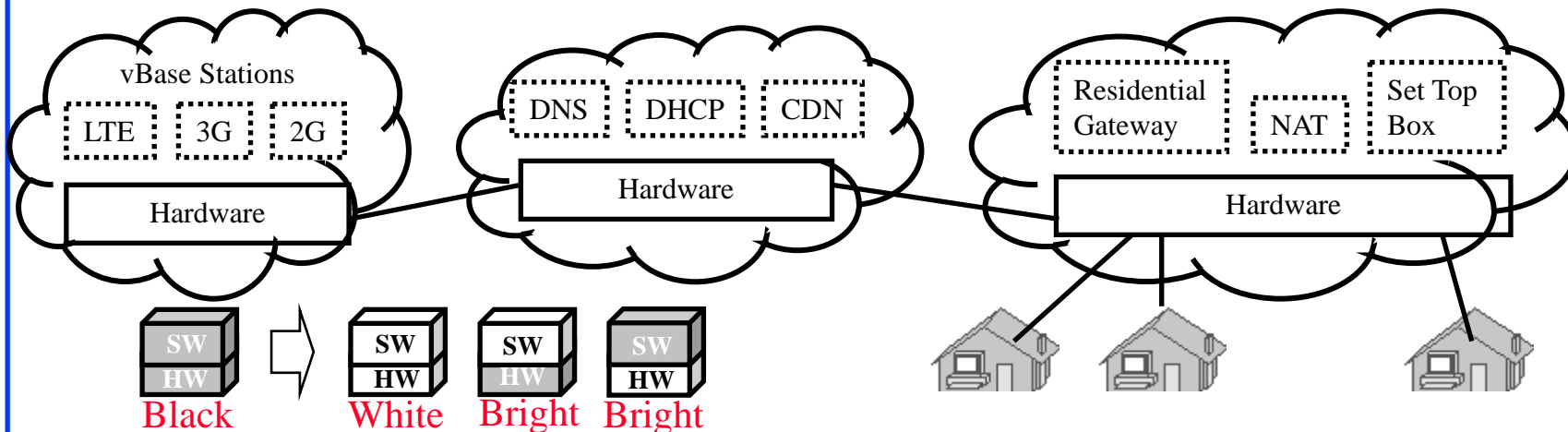

Ref: ETSI, "NFV – Update White Paper V3," Oct 2014, http://portal.etsi.org/NFV/NFV_White_Paper3.pdf (Must read)
Washington University in St. Louis <http://www.cse.wustl.edu/~jain/cse570-21/>

©2021 Raj Jain

Student Questions

- What do you mean by white box implementation?

White Box = Open source software and open source hardware. See Bright box too.

- What is the difference between SDN and NFV?

See Slide 16-7

NFV (Cont)

3. Virtual Machine implementation

⇒ Virtual appliances

⇒ All advantages of virtualization (quick provisioning, scalability, mobility, Reduced CapEx, Reduced OpEx, ...)

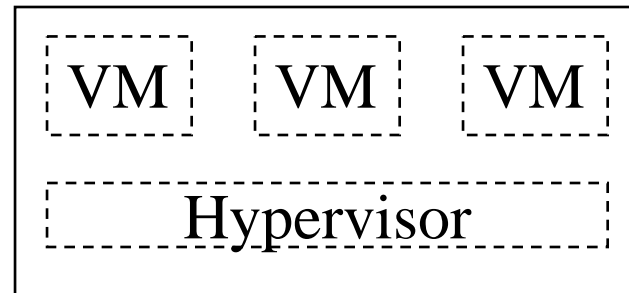

Partitioning

4. **Standard APIs:** New ISG (Industry Specification Group) in ETSI (European Telecom Standards Institute) set up in November 2012

Student Questions

Why We need NFV?

- 1. Virtualization:** Use network resource without worrying about where it is physically located, how much it is, how it is organized, etc.
- 2. Orchestration:** Manage thousands of devices
- 3. Programmable:** Should be able to change behavior on the fly.
- 4. Dynamic Scaling:** Should be able to change size, quantity
- 5. Automation**
- 6. Visibility:** Monitor resources, connectivity
- 7. Performance:** Optimize network device utilization
- 8. Multi-tenancy**
- 9. Service Integration**
- 10. Openness:** Full choice of Modular plug-ins

Note: These are exactly the same reasons why we need SDN.

Student Questions

NFV and SDN Relationship

- ❑ Concept of NFV originated from SDN
 - ⇒ First ETSI white paper showed overlapping Venn diagram
 - ⇒ It was removed in the second version of the white paper
- ❑ NFV and SDN are complementary. One does not strictly depend upon the other. You can do SDN only, NFV only, or SDN and NFV.
- ❑ Both have similar goals but approaches are very different.
- ❑ Management/virtualization of large networks becomes easier with SDN
- ❑ SDN needs new interfaces, control modules, applications. NFV requires moving network applications from dedicated hardware to virtual containers on commercial-off-the-shelf (COTS) hardware.
- ❑ NFV is present. SDN is the future.
- ❑ Multiple flavors of SDN resulting in a debate. Not much debate about NFV.

Student Questions

- ❑ What challenges will telecom operators face in deploying NFV?
What to do with their current expensive equipment and people?
- ❑ So compared to SDN, NFV is also software-based (to do virtualization of hardware), but does not necessarily have the disaggregation feature?
It is an application and superset of SDN. Disaggregation of HW and SW is a part of NFV too.
- ❖ It says that FDV originated from SDN. So why NFV is present. SDN is the future, not the other way around?
The statement was made in 2013. At that time SDN was there but not final.

Mobile Network Functions

- ❑ Switches, e.g., Open vSwitch
- ❑ Routers, e.g., Click
- ❑ Home Location Register (HLR),
- ❑ Serving GPRS Support Node (SGSN),
- ❑ Gateway GPRS Support Node (GGSN),
- ❑ Combined GPRS Support Node (CGSN),
- ❑ Radio Network Controller (RNC),
- ❑ Serving Gateway (SGW),
- ❑ Packet Data Network Gateway (PGW),
- ❑ Residential Gateway (RGW),
- ❑ Broadband Remote Access Server (BRAS),
- ❑ Carrier Grade Network Address Translator (CGNAT),
- ❑ Deep Packet Inspection (DPI),
- ❑ Provider Edge (PE) Router,
- ❑ Mobility Management Entity (MME),
- ❑ Element Management System (EMS)

Student Questions

VNF

- ❑ **NFV Infrastructure (NFVI):** Hardware and software required to deploy, manage and execute VNFs
- ❑ **Network Function (NF):** Functional building block with a well defined interfaces and well defined functional behavior
- ❑ **Virtualized Network Function (VNF):** Software implementation of NF that can be deployed in a virtualized infrastructure
- ❑ **Container:** VNF is independent of NFVI but needs a container software on NFVI to be able to run on different hardware

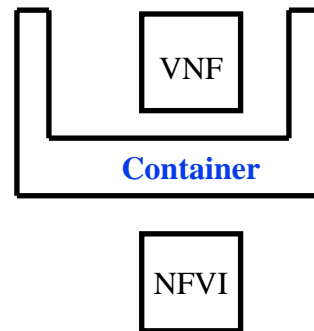

Student Questions

- ❑ Is container a kind of hypervisor?
Kind of. It is a complete virtual machine. Taught in latest software classes.
- ❑ If we want to deploy the same VNF to different machines, such as from mac to windows, do we only need to deploy the container without modifying the VNF?
Container mainly specify the interfaces/requirements and if hardware does not satisfy those requirements, it may not run.

NFV Concepts

- ❑ **Containers Types:** Related to Computation, Networking, Storage
- ❑ **VNF Components (VNFC):** A VNF may have one or more components
- ❑ **VNF Set:** Connectivity between VNFs is not specified, e.g., residential gateways
- ❑ **VNF Forwarding Graph:** Service chain when network connectivity order is important, e.g., firewall, NAT, load balancer

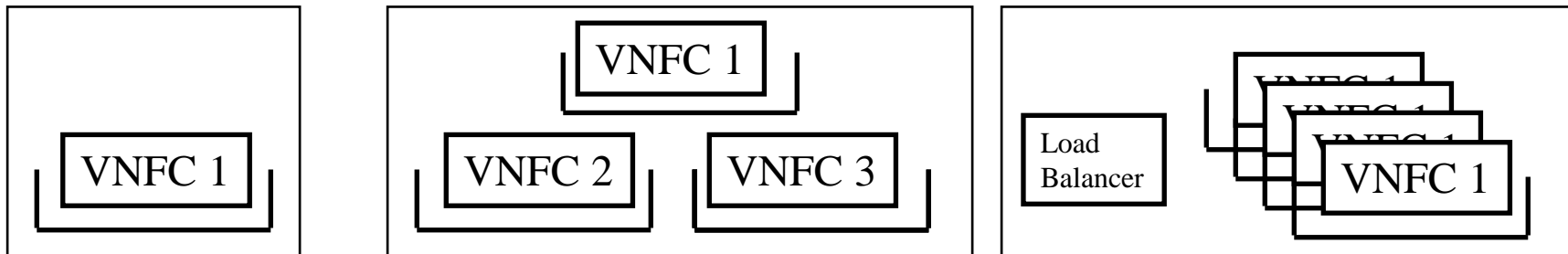

Ref: ETSI, “Architectural Framework,” 2015 , http://www.etsi.org/deliver/etsi_gs/NFV/001_099/002/01.02.01_60/gs_NFV002v010201p.pdf

Ref: ETSI, “NFV Terminology for Main Concepts in NFV,” 2015,

http://www.etsi.org/deliver/etsi_gs/NFV/001_099/003/01.02.01_60/gs_NFV003v010201p.pdf

Student Questions

Network Forwarding Graph

- An end-to-end service may include nested forwarding graphs

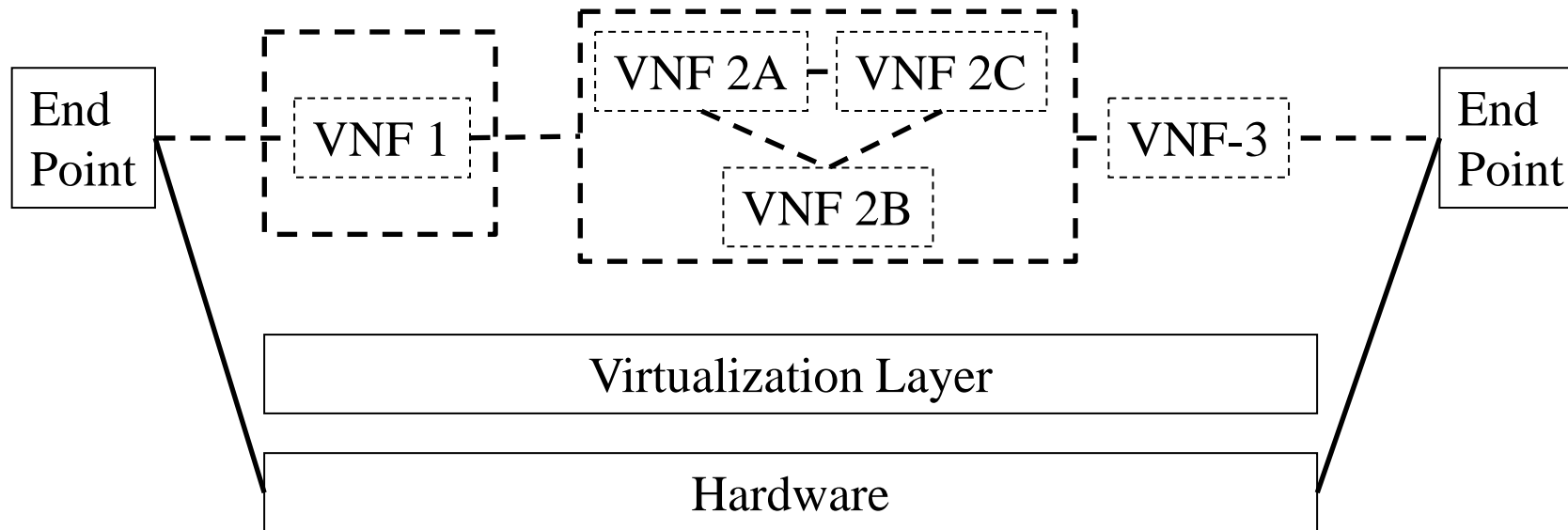

Student Questions

Ref: ETSI, "Architectural Framework," 2015, |

http://www.etsi.org/deliver/etsi_gs/NFV/001_099/002/01.02.01_60/gs_NFV002v010201p.pdf

Washington University in St. Louis

<http://www.cse.wustl.edu/~jain/cse570-21/>

©2021 Raj Jain

NFV Concepts (Cont)

- ❑ **NFVI Point of Presence (PoP):** Location of NFVI
- ❑ **NFVI-PoP Network:** Internal network
- ❑ **Transport Network:** Network connecting a PoP to other PoPs or external networks
- ❑ **VNF Manager:** VNF lifecycle management e.g., instantiation, update, scaling, query, monitoring, fault diagnosis, healing, termination
- ❑ **Virtualized Infrastructure Manager:** Management of computing, storage, network, software resources
- ❑ **Network Service:** A composition of network functions and defined by its functional and behavioral specification
- ❑ **NFV Service:** A network services using NFs with at least one VNF.

Student Questions

Is PoP a physical location?

Infrastructure is physical. Virtual infrastructure is virtual.

❑ Does it have to be permanent?

Physical infrastructure can be relocated with some difficulty. Virtual infrastructure can be moved easily.

NFV Concepts (Cont)

- ❑ **User Service:** Services offered to end users/customers/subscribers.
- ❑ **Deployment Behavior:** NFVI resources that a VNF requires, e.g., Number of VMs, memory, disk, images, bandwidth, latency
- ❑ **Operational Behavior:** VNF instance topology and lifecycle operations, e.g., start, stop, pause, migration, ...
- ❑ **VNF Descriptor:** Deployment behavior + Operational behavior
- ❑ **NFV Orchestrator:** Automates the deployment, operation, management, coordination of VNFs and NFVI.
- ❑ **VNF Forwarding Graph:** Connection topology of various NFs of which at least one is a VNF

Student Questions

NFV Reference Points

Reference Point: Points for inter-module specification

1. Virtualization Layer-Hardware Resources (**VI-Ha**)
2. VNF – NFVI (**Vn-Nf**)
3. Orchestrator – VNF Manager (**Or-Vnfm**)
4. Virtualized Infrastructure Manager – VNF Manager (**Vi-Vnfm**)
5. Orchestrator – Virtualized Infrastructure Manager (**Or-Vi**)
6. NFVI-Virtualized Infrastructure Manager (**Nf-Vi**)
7. Operation Support System (OSS)/Business Support Systems (BSS) – NFV Management and Orchestration (**Os-Ma**)
8. VNF/ Element Management System (EMS) – VNF Manager (**Ve-Vnfm**)
9. Service, VNF and Infrastructure Description – NFV Management and Orchestration (**Se-Ma**): VNF Deployment template, VNF Forwarding Graph, service-related information, NFV infrastructure information

Ref: ETSI, “Architectural Framework,” 2015, http://www.etsi.org/deliver/etsi_gs/NFV/001_099/002/01.02.01_60/gs_NFV002v010201p.pdf

Washington University in St. Louis

<http://www.cse.wustl.edu/~jain/cse570-21/>

©2021 Raj Jain

Student Questions

NFV Architecture

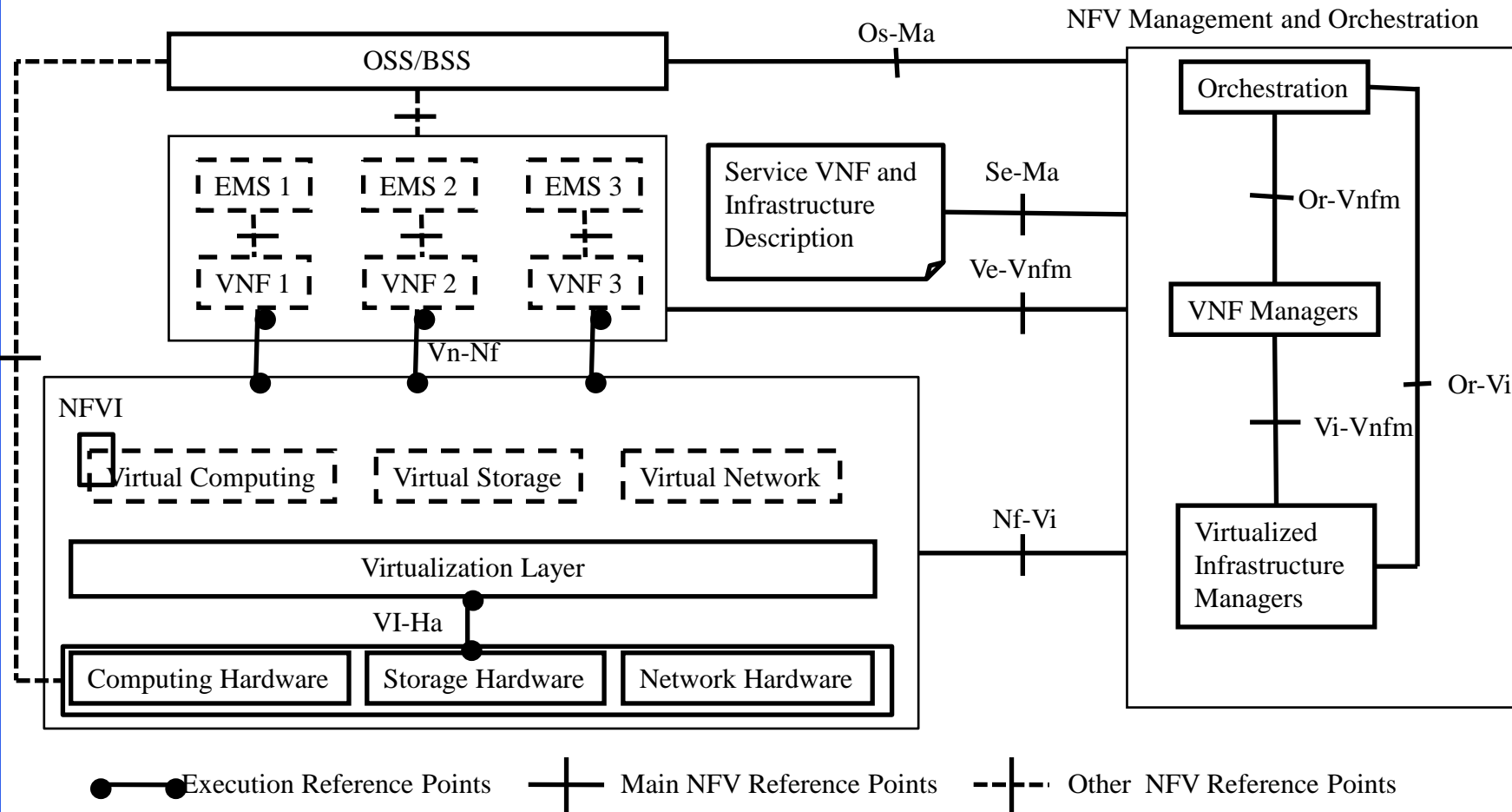

Student Questions

- ❑ Could you explain this architecture again in detail please?

Sure.

Ref: ETSI, "Architectural Framework," 2015,

http://www.etsi.org/deliver/etsi_gs/NFV/001_099/002/01.02.01_60/gs_NFV002v010201p.pdf

Washington University in St. Louis

<http://www.cse.wustl.edu/~jain/cse570-21/>

©2021 Raj Jain

NFV Framework Requirements

1. **General**: Partial or full Virtualization, Predictable performance
2. **Portability**: Decoupled from underlying infrastructure
3. **Performance**: as described and facilities to monitor
4. **Elasticity**: Scalable to meet SLAs. Movable to other servers.
5. **Resiliency**: Be able to recreate after failure.
Specified packet loss rate, calls drops, time to recover, etc.
6. **Security**: Role-based authorization, authentication
7. **Service Continuity**: Seamless or non-seamless continuity after failures or migration

Ref: ETSI, “NFV Virtualization Requirements,” 2015,

http://www.etsi.org/deliver/etsi_gs/NFV/001_099/004/01.01.01_60/gs_NFV004v010101p.pdf

Washington University in St. Louis

<http://www.cse.wustl.edu/~jain/cse570-21/>

©2021 Raj Jain

Student Questions

NFV Framework Requirements (Cont)

8. **Service Assurance:** Time stamp and forward copies of packets for Fault detection
9. **Energy Efficiency Requirements:** Should be possible to put a subset of VNF in a power conserving sleep state
10. **Transition:** Coexistence with Legacy and Interoperability among multi-vendor implementations
11. **Service Models:** Operators may use NFV infrastructure operated by other operators

Student Questions

- If a fault is detected, what will NFV do to correct this fault?

Ring an alarm. Recovery can be automated but that will be standardized slowly.

Researchers are working on intelligent (AI-Based) network management.

- Please can you explain the difference between Transition and Service Models?

Transition=Moving from one to another

Service model = who serves whom

NFV Use Cases

- ❑ **Home Environment:** Virtualization of the Home environment
- ❑ **CDNS:** Virtualization of Content Distribution Networks
- ❑ **Fixed Access Network:** Fixed Access NFV
- ❑ **NFVIaaS:** NFVI as a service like IaaS
- ❑ **VNFaaS:** VNFs as a service like SaaS
- ❑ **VNPaaS:** Virtual Network Platform as a Service like PaaS
- ❑ **VNF Forwarding Graph:** VNF forwarding graphs (Service Chains)
- ❑ **Mobile Core and IMS:** Virtualization of the Mobile Core Network and IP Multimedia System
- ❑ **Mobile Base Station:** Virtualization of Mobile Base Station

Student Questions

- ❑ Can you explain what is the IaaS.

Infrastructure as a Service = provide resources

ETSI NFV ISG

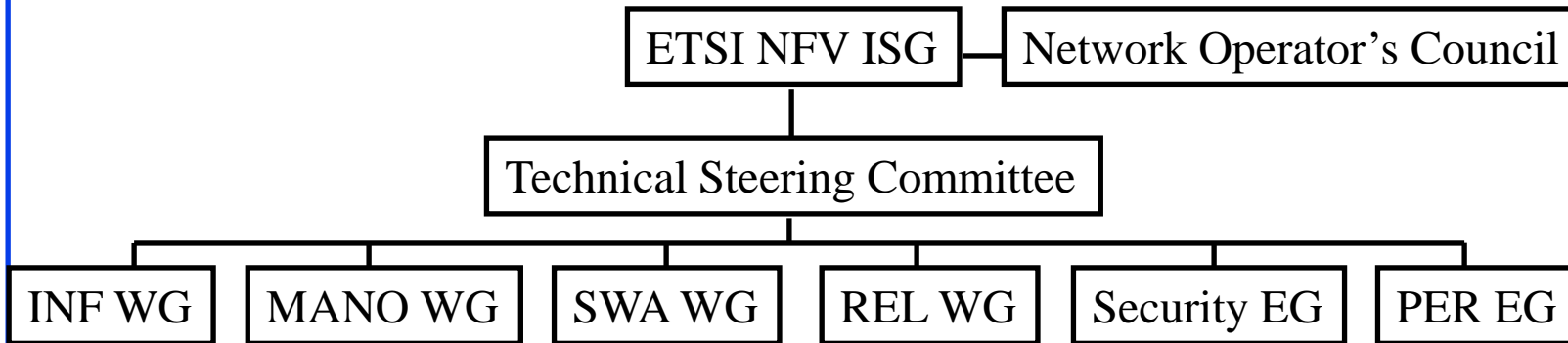

- ❑ Industry Specification Group (ISG)'s goal is to define the requirements.
- ❑ Four Working Groups:
 - **INF**: Architecture for the virtualization Infrastructure
 - **MANO**: Management and orchestration
 - **SWA**: Software architecture
 - **REL**: Reliability and Availability, resilience and fault tolerance

Ref: M. Cohn, "NFV, An Insider's Perspective: Part 1: Goals, History, and Promise," Sep 2013,

<http://www.sdncentral.com/education/nfv-insiders-perspective-part-1-goals-history-promise/2013/09/>

Washington University in St. Louis

<http://www.cse.wustl.edu/~jain/cse570-21/>

©2021 Raj Jain

Student Questions

ETSI NFV ISG (Cont)

- Two Expert Groups:
 - **Security** Expert Group: Security
 - **Performance and Portability** Expert Group: Scalability, efficiency, and performance VNFs relative to current dedicated hardware

Student Questions

ETSI NFV Release 2.0

- ❑ 2015-2016. INF, SWA disbanded. Several new groups.
- ❑ IFA: Interfaces and Architecture
 - Fault, performance, and lifecycle management of virtualized resources, VNFs, and network services
 - Package and software image management
 - Capacity management, Policy Management
 - Information models
- ❑ REL: Reliability and Availability, resilience and fault tolerance
- ❑ SEC: Security analysis and management
- ❑ EVE: Evolution and Ecosystem working group
 - Charging, Billing, and Accounting, License Management
- ❑ TST: Testing, DevOps, Continuous Integration

Ref: <http://www.etsi.org/technologies-clusters/technologies/689-network-functions-virtualisation>

Washington University in St. Louis

<http://www.cse.wustl.edu/~jain/cse570-21/>

©2021 Raj Jain

Student Questions

- ❖ This slide is marked as "release 2.0", should we consider slides 16-19 and 16-20 as release 1.0?

Yes.

ETSI NFV Release 3

- ❑ 2017-2018
- ❑ IFA, EVE, REL, SEC, and TST continue

Student Questions

NFV Proof of Concepts (PoCs)

ETSI has formed and NFV ISG PoC Forum.

Following modules have been demoed:

1. Virtual Broadband Remote Access Server (BRAS) by British Telecom
2. Virtual IP Multimedia System (IMS) by Deutsche Telekom
3. Virtual Evolved Packet Core (vEPC) by Orange Silicon Valley
4. Carrier-Grade Network Address Translator (CGNAT) and Deep Packet Inspection (DPI), Home Gateway by Telefonica
5. Perimeta Session Border Controller (SBC) from Metaswitch
6. Deep packet inspection from Procera

Most of these are based on Cloud technologies, e.g., OpenStack

Ref: M. Cohn, "NFV Group Flocks to Proof-of-Concept Demos," Aug 2013,

<http://www.sdncentral.com/technology/nfv-group-flocks-to-proof-of-concept-models/2013/08/>

Student Questions

OPNFV

- ❑ Open Source NFV implementation project under Linux Foundation (Similar to OpenDaylight)
- ❑ Founded September 2014
- ❑ Initial goal to integrate KVM, OpenStack, and OpenDaylight
- ❑ Integrated project will be run through software testing labs at service providers

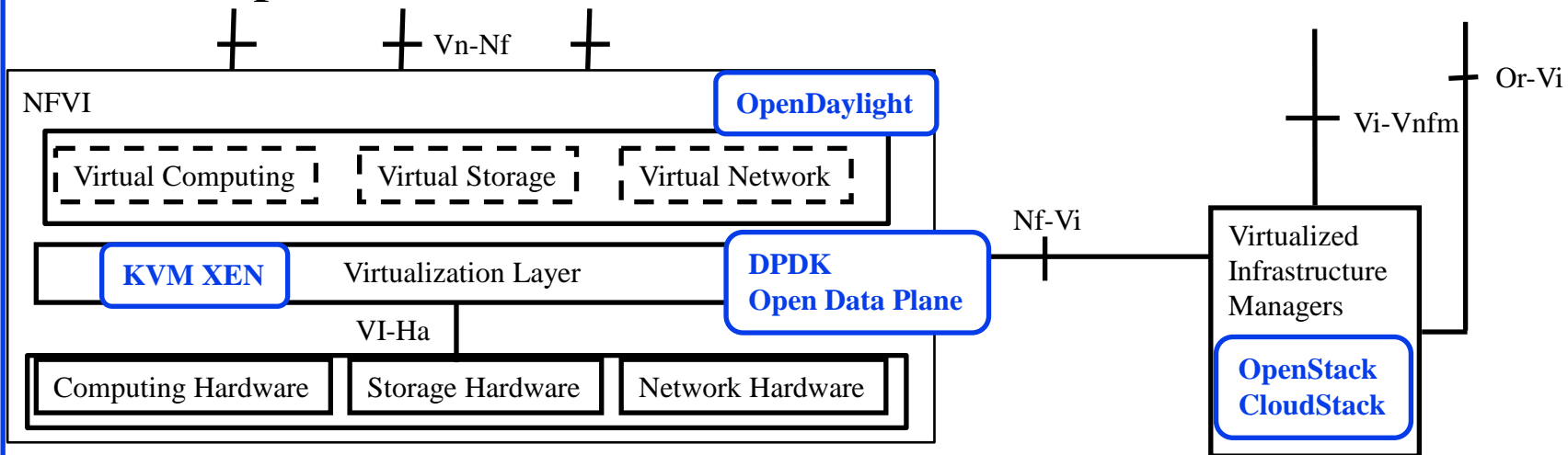

Student Questions

- ❑ Was this move to Open Source inspired by the same transition in SDN? Or were they both natural progressions on their own?

NFV was inspired by SDN. While SDN was being debated, carriers got together and thought of an interim solution and called it NFV.

Service Chaining in a Multi-Cloud Multi-Tenant Environment

- ❑ VNFs (Virtual network fns) belong to tenants. Multiple tenants.
- ❑ Each Cloud belongs to a different Cloud Service Provider (CSP)
- ❑ Internet infrastructure belongs to an NFVI service provider (NSP)
- ❑ Service chain = Workflow

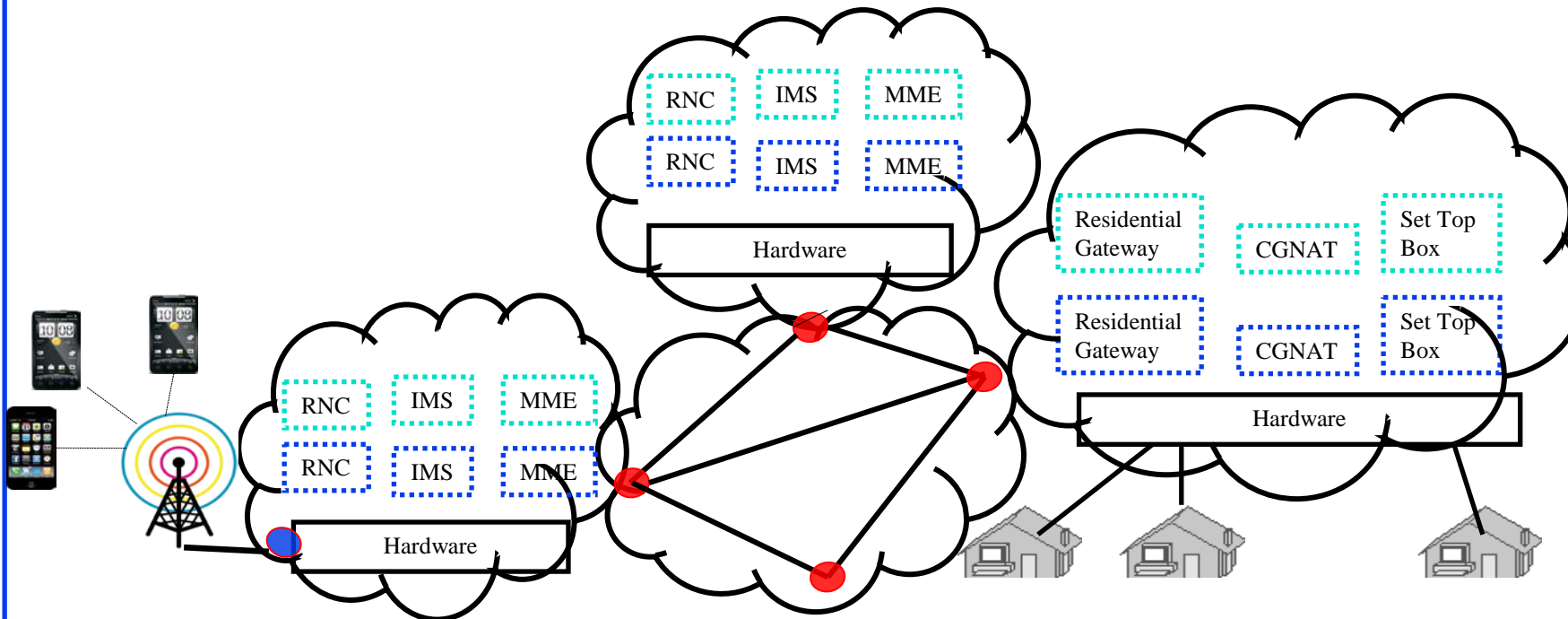

Student Questions

Challenges in Service Chaining

❑ **Dynamic:**

- Forwarding changes with state of the servers, links, ...
- Independent of physical topology

❑ **Content sensitive:**

- Different for different types of videos, read-writes, ...

❑ **Distributed Control:**

- Equipment belongs to infrastructure provider
- Data belongs to Tenants

❑ **Massive Scale:**

- Billions of users with different user context

❑ **Stateful Services:**

- All packets of a flow should be sent to the same replica
 - ❑ Message level services (firewalls),
 - ❑ Packet level services (intrusion detection)

Student Questions

Service Function Chaining Terminology

- ❑ Defined by IETF SFC Working group
- ❑ **Service**: E.g., Video streaming. Consists of a number of functions.
- ❑ **Service Function**: E.g., Firewall, Compression, Video Translation

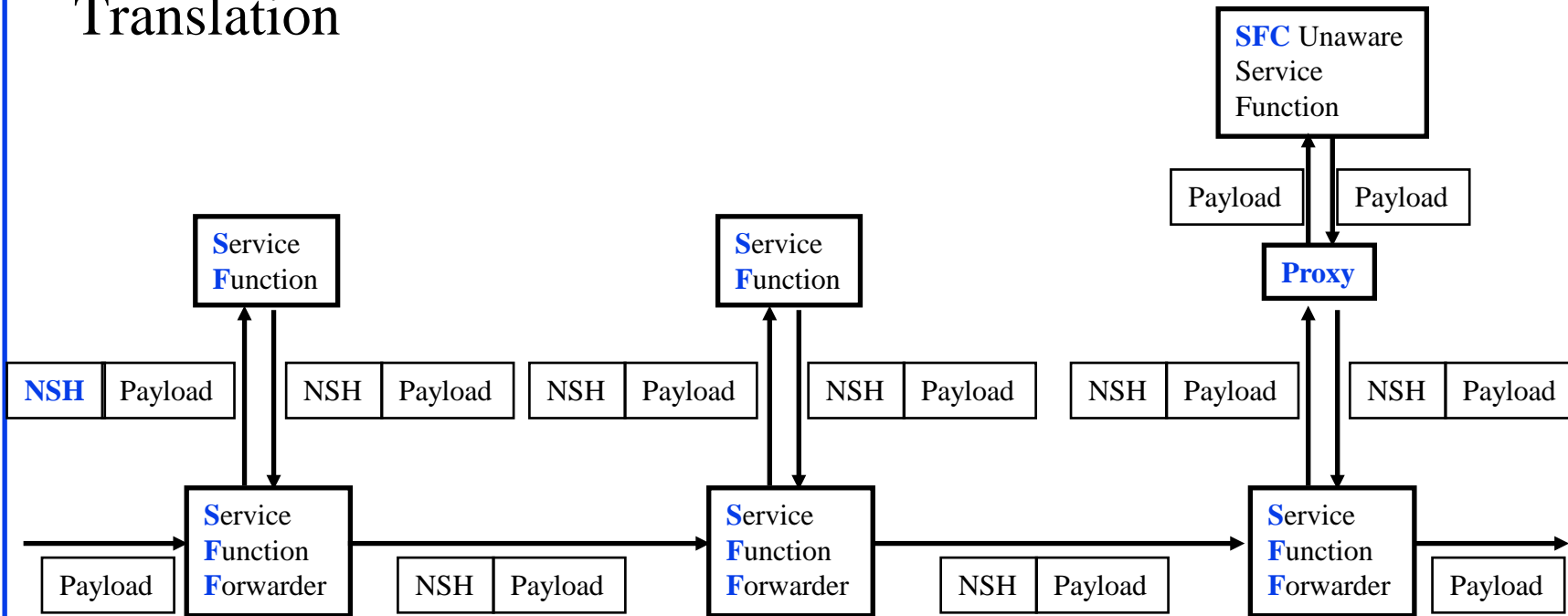

Ref: RFC 7498, "Problem Statement for Service Function Chaining," Nov. 2015, <https://www.rfc-editor.org/rfc/pdf/rfc7498.txt.pdf>
 Washington University in St. Louis <http://www.cse.wustl.edu/~jain/cse570-21/> ©2021 Raj Jain

Student Questions

- ❑ Could you explain the picture again in detail please?

Sure.

- ❑ Can you please show where is SFP in this figure? Is the "proxy" a connection or translation btw brownfield(old) and greenfield(new)?

Proxy, here, is legacy to SFC adapter.

- ❑ Is the service function meant to be a piece of software or specialized hardware intergrated to a router, or a separate centralized controller that the service function forwarder send packets to?

Service function is a "function" that can be implemented in s/w or h/w. Examples of SF are routing, firewall, load balancer, etc.

- ❑ What about SFF? Is it a specialized router or a software running in a router?....

SFF is a "service function switch" that sends packets to the correct service function.

SFC Terminology (Cont)

- ❑ **Service Function Chain:** A forwarding graph
- ❑ A service function may have more than one instance.
- ❑ Number and location of instances changes with time
- ❑ All packets of a flow should be forwarded to the same instance
- ❑ **Service Function Path (SFP):** A sequence of service functions for a particular service
- ❑ **Network Service Header (NSH):** Added to forward packets dynamically to correct instances of the service function
- ❑ **Service Function Forwarder (SFF):** Forwards the packets to correct instance using NSH. May add/delete NSH if needed.
- ❑ **Proxy:** Helps use legacy functions. Removes/Adds NSH header before sending the packet to SFC unaware functions.

Student Questions

- ❑ Can an SFC have a loop?
No SFCs are manually designed.

SFC Terminology (Cont)

- ❑ Transport: Between the SFFs, SFs, and Proxies. E.g., Ethernet, GRE, VXLAN, TCP, ...
- ❑ NSH encapsulated packet is sent using the transport header to the next SFC element.



- ❑ **Metadata:** Data passed between SFC elements. Part of the NSH
- ❑ **Service Path Identifier (SPI):** A service function path may have many instances. Each instance has a SPI.
- ❑ **Service Index:** Each function on the SFP has a service index.

Student Questions

- ❑ I didn't see SPI in the figure in slide 27, could you please show me where SPI works?

SPI is a field in the header. It serves as a "Service function ID" (i.e., "Address")

Network Service Header

- Consists of “*base header*”, “*service path header*”, and zero or more “*context headers*.”

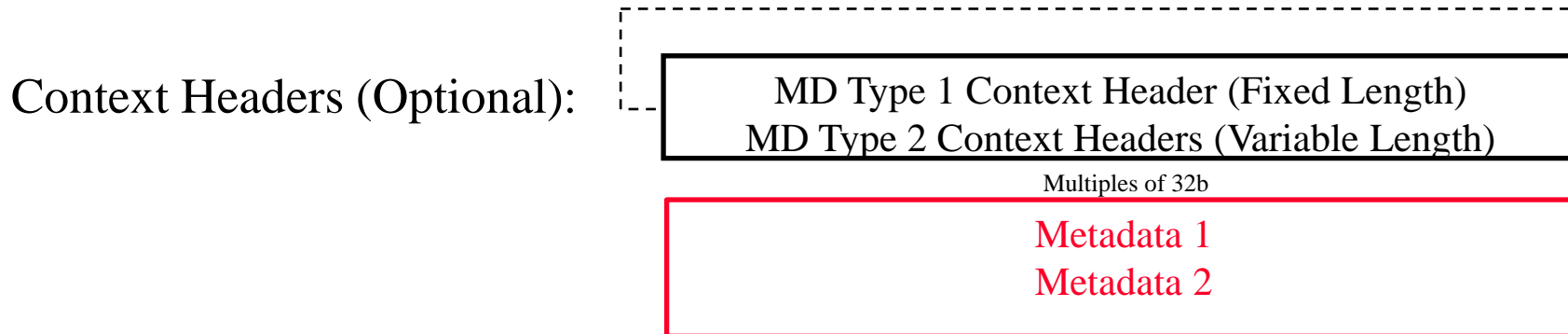
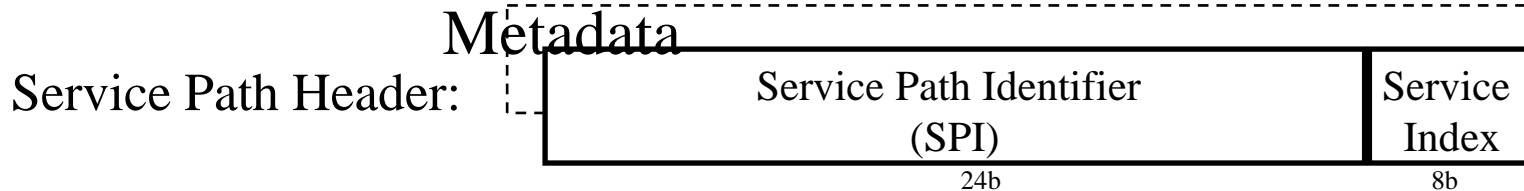
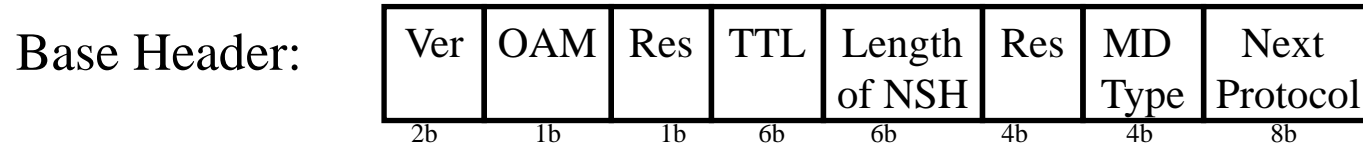

Student Questions

- Can you please show the metadata field? Metadata type is already shown. is it part of the payload?
Metadata follows the MD type.
- ❖ The service index field is 8b, yet the SPI field is 24b, in other words, how many services can be chained? 2 to the power of?

2^8

NSH (Cont)

- ❑ TTL: # of SFC hops to live
- ❑ Length: Total length of NSH header including base, service path, and context headers in bytes
- ❑ MD Type: Type of the metadata (context header)
 - 1 = Fixed length
 - 2 = Variable length

Student Questions

- ❑ Why do we have two Res fields in the base header?
These bits were left-over due to byte alignment of the next field.
- ❑ Since the context header is optional, does this mean the metadata is optional? If so and we don't have metadata, what to put in the MD type field?

Service index = 0

⇒ No metadata

SPRING

- ❑ Source Packet Routing in Networking – An IETF working group
- ❑ NSH requires maintaining state in all SFFs
- ❑ Source routing is an alternative in which no state is maintained in the intermediate nodes. The packet header contains the route.
- ❑ Source routing is limited to IP addresses
- ❑ Segment Routing = Generalization of source routing
 - MPLS Label = Segment
 - IP address = Segment
- ❑ Differentiate between elephant storage flows and mice compute flows
- ❑ Although SPRING working group is not for NFV, Segment routing can be used for Service Function Chaining

Student Questions

Management and Orchestration (MANO)

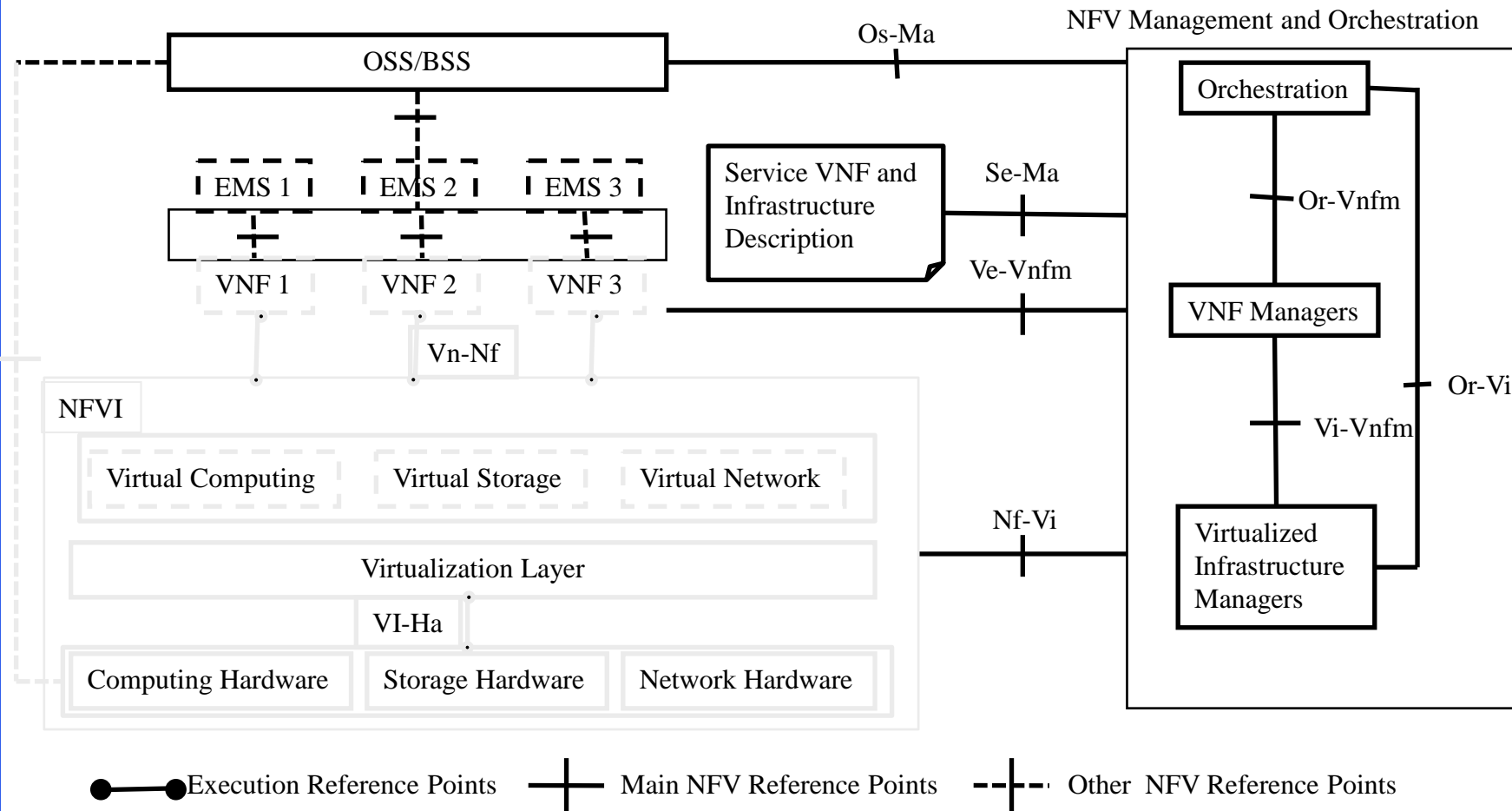

Student Questions

Ref: ETSI, "Architectural Framework," 2015,

http://www.etsi.org/deliver/etsi_gs/NFV/001_099/002/01.02.01_60/gs_NFV002v010201p.pdf

Washington University in St. Louis

<http://www.cse.wustl.edu/~jain/cse570-21/>

©2021 Raj Jain

MANO (Cont)

- ❑ Operation Support System (OSS)
- ❑ Business Support System (BSS)
- ❑ Element Management System, VNF Management, Infrastructure Management, Orchestration

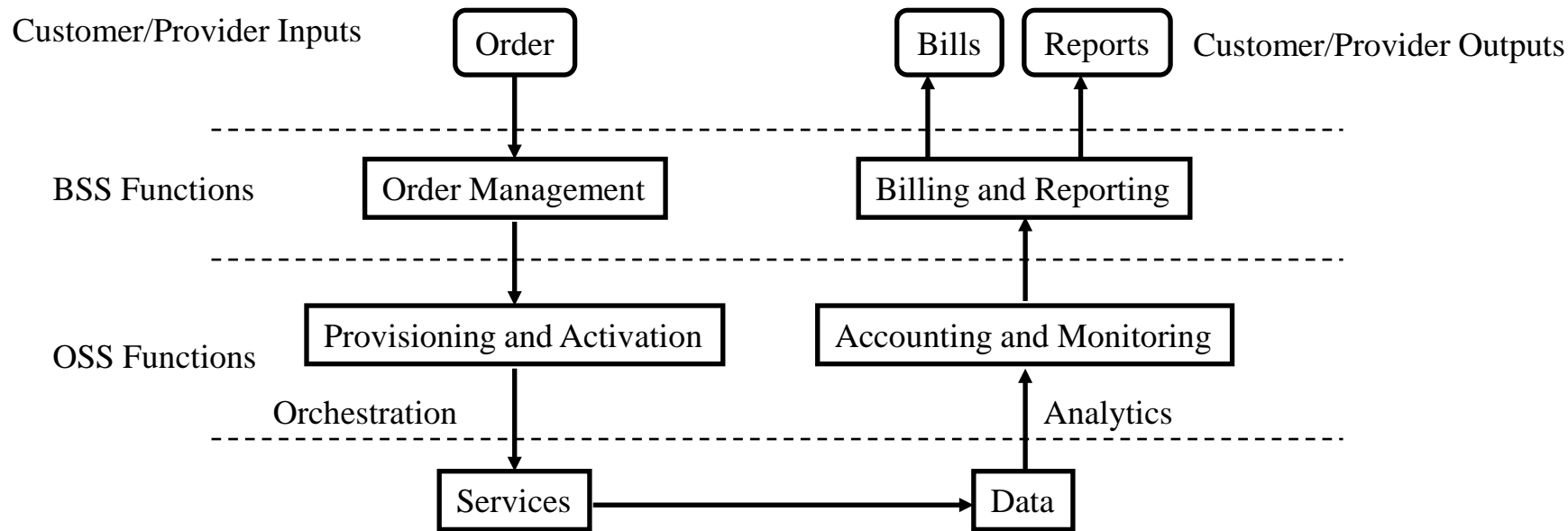

Ref: Ken Gray and Thomas Nadeau, "Network Function Virtualization," Morgan Kaufmann, July 2016, 238 pp., ISBN: 978-0-12-802119-4, (Safari Book) Washington University in St. Louis

<http://www.cse.wustl.edu/~jain/cse570-21/>

©2021 Raj Jain

Student Questions

- ❑ Could you explain briefly again those concepts NFC, Service chaining? It's quite confusing.

NFC=Network Function Components

SFC=Service Function Chaining

SFC may consist of many SFs.

Each SF may have many NFCs.

- ❑ Could you explain again how does MANO fit in the NFV architecture?

MANO is the management plane for NFV.

- ❑ Are OSS and BSS exclusive to each other? Can they be used together?

Each system needs both OSS and BSS.

OSS is used for operating the system

(Boot, run, fault detection, shutdown).

BSS is used for business (billing, etc.)

- ❑ Could you please explain this figure again?

Sure.

NGOSS

- ❑ Next Generation OSS
- ❑ Service providers have many different OSSs
 - Mostly using polling/event monitoring
 - All proprietary and often incompatible ⇒ High OpEx
- ❑ Next Generation OSS (NGOSS) being discussed in TeleManagement Forum (TM Forum)
- ❑ Enhanced Telecom Operations Map (eTOM): Common language for service providers to describe business processes
- ❑ Shared Information/Data Model (SID): Common language for vendors to describe management information
- ❑ Technology Neutral Architecture (TNA) and Contract Interface
- ❑ NGOSS Compliance: A Suite of tests

Ref: “NGOSS (New Generation Operations Systems and Software),” <http://dpm.postech.ac.kr/NGOSS/NGOSS.html>

Student Questions

Open Source MANO Implementations

- ❑ **Open-O**: Linux Foundation project for open orchestration
- ❑ **ECOMP**: Linux Foundation project for Enhanced Control, Orchestration, Management, and Policy (Led by AT&T)
- ❑ **ONAP**: Open Network Automation Platform
Open-O and ECOMP merged at Linux Foundation
- ❑ **TACKER**: OpenStack project for NFV orchestration
- ❑ **Open Source MANO (OSM)**: ETSI effort started by Telefonica in 2015
- ❑ **Open Baton**: Closely follows ETSI MANO
- ❑ Most of these use TOSCA templates

Ref: <https://wiki.open-o.org/>, <https://about.att.com/content/dam/snrdocs/ecomp.pdf>, <https://www.onap.org/>,
<https://wiki.openstack.org/wiki/Tacker>, <http://www.etsi.org/technologies-clusters/technologies/nfv/open-source-mano>,
<https://openbaton.github.io/>

Student Questions

- ❖ Should we remember all these Implementations?
Yes, just until the exam.

TOSCA

- ❑ Topology and Orchestration Specification for Cloud Applications
- ❑ TOSCA template for an application describes the resources required to run the application on a cloud
- ❑ Resources can be compute, network, storage, databases, etc.
- ❑ TOSCA template includes a graph modeling the relationships between various components and operations on them
- ❑ Orchestration engines can use the TOSCA template to create an instance of the application. Resources required are also created in correct order. For example, a database will be created before the program that needs it, etc.

Ref: OASIS, "TOSCA Simple Profile in YAML Version 1.1," Jan 2018, 282 pp.,

<http://docs.oasis-open.org/tosca/TOSCA-Simple-Profile-YAML/v1.1/os/TOSCA-Simple-Profile-YAML-v1.1-os.pdf>

Washington University in St. Louis

<http://www.cse.wustl.edu/~jain/cse570-21/>

©2021 Raj Jain

Student Questions

- ❑ What does "Orchestration engines can create an instance of the application" mean?

Orchestration includes creating a new instance and then controlling it along with the rest of the group.

- ❑ How is TOSCA similar (if at all) and different compared to Terraform/Ansible?

I don't know Terraform/Ansible.

Any Function Virtualization (FV)

- ❑ Network function virtualization of interest to Network service providers
- ❑ But the same concept can be used by any other industry, e.g., financial industry, banks, stock brokers, retailers, mobile games, ...
- ❑ Everyone can benefit from:
 - Functional decomposition of there industry
 - Virtualization of those functions
 - Service chaining those virtual functions (VFs)
⇒ A service provided by the next gen ISPs

Student Questions

- ❑ For the bank application, Is the framework of each bank different? Is the NFV framework a universal framework for banks?

If there were a “Banking Function Virtualization (BFV)” then it will consist of protocols and functions used in banking, e.g., loan, payments, deposits, etc.

- ❖ In the last line, what service do you mean? SFC?

Yes, any service composed by SFCs.

Enterprise App Market: Lower CapEx

Virtual IP
Multimedia
System

Available on the
App Store



Student Questions

Summary

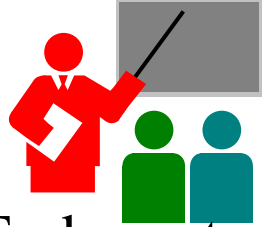

1. NFV aims to reduce OpEx by automation and scalability provided by implementing network functions as virtual appliances
2. NFV allows all benefits of virtualization and cloud computing including orchestration, scaling, automation, hardware independence, pay-per-use, fault-tolerance, ...
3. NFV and SDN are independent and complementary. You can do either or both.
4. NFV requires standardization of reference points and interfaces to be able to mix and match VNFs from different sources
5. NFV can be done now. Several of virtual functions have already been demonstrated by carriers.

Student Questions

Reading List

- ❑ Ken Gray and Thomas Nadeau, “Network Function Virtualization,” Morgan Kaufmann, July 2016, 238 pp., ISBN: 978-0-12-802119-4, (Safari Book) – **Recommended Reading**
- ❑ Jim Doherty, "SDN and NFV Simplified: A Visual Guide to Understanding Software Defined Networks and Network Function Virtualization," Addison-Wesley Professional, March 2, 2016, 320 pp., ISBN:978-0-13-430739-8 (Safari Book).
- ❑ Ying Zhang, "Network Function Virtualization," Wiley-IEEE Press, January 2018, 192 pp., ISBN:978-1-119-39060-2 (Safari Book).
- ❑ Rajendra Chayapathi, Syed Farrukh Hassan, Paresh Shah, "Network Functions Virtualization (NFV) with a Touch of SDN," Addison-Wesley Professional, November 2016, 368 pp., ISBN:978-0-13-446431-2 (Safari Book).
- ❑ Russ White, Jeff Tantsura, "Navigating Network Complexity: Next-generation Routing with SDN, Service Virtualization, and Service Chaining," Addison-Wesley Professional, November 2015, 320 pp., ISBN:0-13-398792-2 (Safari Book).

Student Questions

References

- ❑ ETSI, "Architectural Framework," 2015 ,
http://www.etsi.org/deliver/etsi_gs/NFV/001_099/002/01.02.01_60/gs_NFV002v010201p.pdf
- ❑ ETSI, "NFV - Update White Paper V3," Oct 2014,
http://portal.etsi.org/NFV/NFV_White_Paper3.pdf (Must read)
- ❑ ETSI, "White Paper on NFV priorities for 5G," Feb 2017, 15 pp.,
http://portal.etsi.org/NFV/NFV_White_Paper_5G.pdf
- ❑ ETSI, "NFV Terminology for Main Concepts in NFV," 2015,
http://www.etsi.org/deliver/etsi_gs/NFV/001_099/003/01.02.01_60/gs_NFV003v010201p.pdf
- ❑ ETSI Specifications, see the public download directory at
https://docbox.etsi.org/ISG/NFV/Open/Publications_pdf/Specs-Reports

Student Questions

Acronyms

- ❑ API Application Programming Interface
- ❑ BRAS Broadband Remote Access Server
- ❑ BSS Business Support Systems
- ❑ CapEx Capital Expenditure
- ❑ CDN Content Distribution Network
- ❑ CGNAT Carrier-Grade Network Address Translator
- ❑ CGSN Combined GPRS Support Node
- ❑ COTS Commercial-off-the-shelf
- ❑ DDIO Data Direct I/O Technology
- ❑ DHCP Dynamic Host control Protocol
- ❑ DPI Deep Packet Inspection
- ❑ EMS Element Management System
- ❑ ETSI European Telecom Standards Institute
- ❑ GGSN Gateway GPRS Support Node
- ❑ GPRS General Packet Radio Service
- ❑ HLR Home Location Register
- ❑ IaaS Infrastructure as a Service

Student Questions

Acronyms (Cont)

- ❑ IETF Internet Engineering Task Force
- ❑ IMS IP Multimedia System
- ❑ INF Architecture for the virtualization Infrastructure
- ❑ IP Internet Protocol
- ❑ ISG Industry Specification Group
- ❑ LSP Label Switched Path
- ❑ MANO Management and orchestration
- ❑ MME Mobility Management Entity
- ❑ NAT Network Address Translation
- ❑ NF Network Function
- ❑ NFV Network Function Virtualization
- ❑ NFVI Network Function Virtualization Infrastructure
- ❑ NFVIaaS NFVI as a Service
- ❑ NIC Network Interface Card
- ❑ OpEx Operational Expenses
- ❑ OS Operating System

Student Questions

Acronyms (Cont)

- ❑ OSS Operation Support System
- ❑ PaaS Platform as a Service
- ❑ PE Provider Edge
- ❑ PGW Packet Data Network Gateway
- ❑ PoC Proof-of-Concept
- ❑ PoP Point of Presence
- ❑ PSTN Public Switched Telephone Network
- ❑ QoS Quality of Service
- ❑ REL Reliability, Availability, resilience and fault tolerance group
- ❑ RGW Residential Gateway
- ❑ RNC Radio Network Controller
- ❑ SaaS Software as a Service
- ❑ SBC Session Border Controller
- ❑ SDN Software Defined Networking
- ❑ SGSN Serving GPRS Support Node
- ❑ SGW Serving Gateway

Student Questions

Acronyms (Cont)

- ❑ SIP Session Initiation Protocol
- ❑ SLA Service Level Agreement
- ❑ SWA Software architecture
- ❑ TAS Telephony Application Server
- ❑ TMF TM Forum
- ❑ vEPC Virtual Evolved Packet Core
- ❑ VM Virtual Machine
- ❑ VNF Virtual Network Function
- ❑ VNFaaS VNF as a Service
- ❑ vSwitch Virtual Switch
- ❑ VT-d Virtualization Technology for Direct IO
- ❑ VT-x Virtualization Technology

Student Questions

Scan This to Download These Slides



Raj Jain

<http://rajjain.com>

Student Questions

http://www.cse.wustl.edu/~jain/cse570-21/m_16sdn.htm

Washington University in St. Louis

<http://www.cse.wustl.edu/~jain/cse570-21/>

©2021 Raj Jain

Related Modules



CSE567M: Computer Systems Analysis (Spring 2013),

https://www.youtube.com/playlist?list=PLjGG94etKypJEKjNAa1n_1X0bWWNyZcof

CSE473S: Introduction to Computer Networks (Fall 2011),

https://www.youtube.com/playlist?list=PLjGG94etKypJWOSPMh8Azcg5e_10TiDw



Wireless and Mobile Networking (Spring 2016),

https://www.youtube.com/playlist?list=PLjGG94etKypKeb0nzyN9tSs_HCd5c4wXF

CSE571S: Network Security (Fall 2011),

<https://www.youtube.com/playlist?list=PLjGG94etKypKvzfVtutHcPFJXumyyg93u>



Video Podcasts of Prof. Raj Jain's Lectures,

<https://www.youtube.com/channel/UCN4-5wzNP9-ruOzQMs-8NUw>

Student Questions