

Introduction to Queueing Theory

Raj Jain
Washington University in Saint Louis
Saint Louis, MO 63130
Jain@cse.wustl.edu

Audio/Video recordings of this lecture are available at:

<http://www.cse.wustl.edu/~jain/cse567-17/>



- ❑ Queueing Notation
- ❑ Rules for All Queues
- ❑ Little's Law
- ❑ Types of Stochastic Processes

Basic Components of a Queue

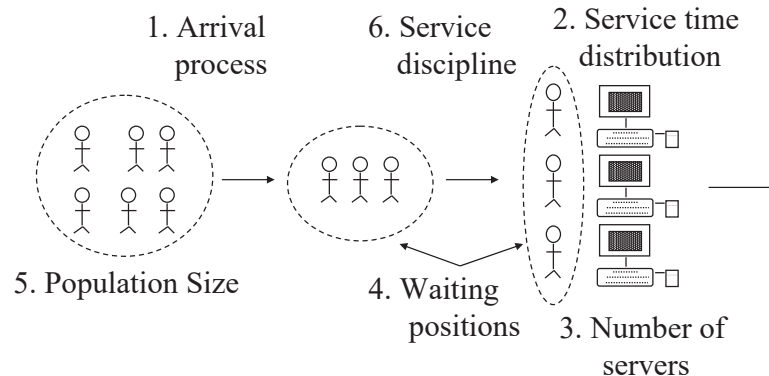

Kendall Notation $A/S/m/B/K/SD$

- ❑ A : Arrival process
- ❑ S : Service time distribution
- ❑ m : Number of servers
- ❑ B : Number of buffers (system capacity)
- ❑ K : Population size, and
- ❑ SD : Service discipline

Arrival Process

- ❑ Arrival times: t_1, t_2, \dots, t_j
- ❑ Interarrival times: $\tau_j = t_j - t_{j-1}$
- ❑ τ_j form a sequence of *Independent and Identically Distributed* (IID) random variables
- ❑ Notation:
 - M = Memoryless \Rightarrow Exponential
 - E = Erlang
 - H = Hyper-exponential
 - D = Deterministic \Rightarrow constant
 - G = General \Rightarrow Results valid for all distributions

Service Time Distribution

- ❑ Time each student spends at the terminal.
- ❑ Service times are IID.
- ❑ Distribution: M, E, H, D, or G
- ❑ Device = Service center = Queue
- ❑ Buffer = Waiting positions

Service Disciplines

- ❑ First-Come-First-Served (FCFS)
- ❑ Last-Come-First-Served (LCFS) = Stack (used in 9-1-1 calls)
- ❑ Last-Come-First-Served with Preempt and Resume (LCFS-PR)
- ❑ Round-Robin (RR) with a fixed quantum.
- ❑ Small Quantum \Rightarrow Processor Sharing (PS)
- ❑ Infinite Server: (IS) = fixed delay
- ❑ Shortest Processing Time first (SPT)
- ❑ Shortest Remaining Processing Time first (SRPT)
- ❑ Shortest Expected Processing Time first (SEPT)
- ❑ Shortest Expected Remaining Processing Time first (SERPT).
- ❑ Biggest-In-First-Served (BIFS)
- ❑ Loudest-Voice-First-Served (LVFS)

Example *M/M/3/20/1500/FCFS*

- ❑ Time between successive arrivals is exponentially distributed.
- ❑ Service times are exponentially distributed.
- ❑ Three servers
- ❑ 20 Buffers = 3 service + 17 waiting
- ❑ After 20, all arriving jobs are lost
- ❑ Total of 1500 jobs that can be serviced.
- ❑ Service discipline is first-come-first-served.
- ❑ Defaults:
 - Infinite buffer capacity
 - Infinite population size
 - FCFS service discipline.
- ❑ $G/G/1 = G/G/1/\infty/\infty/FCFS$

Quiz 30A

□ Key: A/S/m/B/K/SD

T F

- The number of servers in a M/M/1/3 queue is 3
- G/G/1/30/300/LCFS queue is like a stack
- M/D/3/30 queue has 30 buffers
- G/G/1 queue has ∞ population size
- D/D/1 queue has FCFS discipline

Solution to Quiz 30A

□ Key: A/S/m/B/K/SD

T F

- The number of servers in a M/M/1/3 queue is 3
- G/G/1/30/300/LCFS queue is like a stack
- M/D/3/30 queue has 30 buffers
- G/G/1 queue has ∞ population size
- D/D/1 queue has FCFS discipline

Exponential Distribution

□ Probability Density Function (pdf):

$$f(x) = \frac{1}{a} e^{-x/a}$$

□ Cumulative Distribution Function (cdf):

$$F(x) = P(X < x) = \int_0^x f(x) dx = 1 - e^{-x/a}$$

□ Mean: a

□ Variance: a^2

□ Coefficient of Variation = (Std Deviation)/mean = 1

□ Memoryless:

- Expected time to the next arrival is always a regardless of the time since the last arrival
- Remembering the past history does not help.

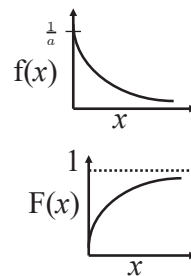

Erlang Distribution

□ Sum of k exponential random variables 
Series of k servers with exponential service times

$$X = \sum_{i=1}^k x_i \text{ where } x_i \sim \text{exponential}$$

□ Probability Density Function (pdf):

$$f(x) = \frac{x^{k-1} e^{-x/a}}{(k-1)! a^k}$$

□ Expected Value: ak

□ Variance: $a^2 k$

□ CoV: $1/\sqrt{k}$

Hyper-Exponential Distribution

- The variable takes i^{th} value with probability p_i

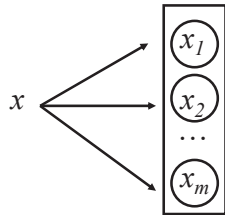

x_i is exponentially distributed with mean a_i

- Higher variance than exponential
Coefficient of variation > 1

Group Arrivals/Service

- Bulk arrivals/service
- $M^{[x]}$: x represents the group size
- $G^{[x]}$: a bulk arrival or service process with general inter-group times.
- Examples:
 - $M^{[x]}/M/1$: Single server queue with bulk Poisson arrivals and exponential service times
 - $M/G^{[x]}/m$: Poisson arrival process, bulk service with general service time distribution, and m servers.

Quiz 30B

- Exponential distribution is denoted as _____
- _____ distribution represents a set of parallel exponential servers
- Erlang distribution E_k with $k=1$ is same as _____ distribution

Solution to Quiz 30B

- Exponential distribution is denoted as M
- Hyperexponential distribution represents a set of parallel exponential servers
- Erlang distribution E_k with $k=1$ is same as Exponential distribution

Key Variables

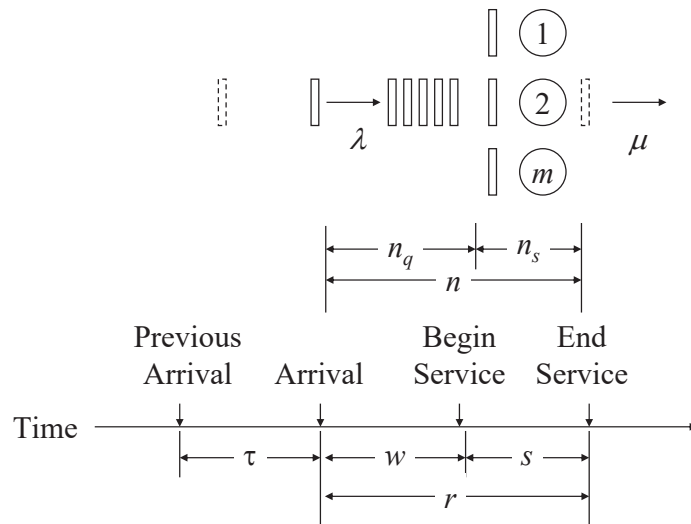

Key Variables (cont)

- τ = Inter-arrival time = time between two successive arrivals.
- λ = Mean arrival rate = $1/E[\tau]$
May be a function of the state of the system, e.g., number of jobs already in the system.
- s = Service time per job.
- μ = Mean service rate per server = $1/E[s]$
- Total service rate for m servers is $m\mu$
- n = Number of jobs in the system.
This is also called **queue length**.
- Note: Queue length includes jobs currently receiving service as well as those waiting in the queue.

Key Variables (cont)

- n_q = Number of jobs waiting
- n_s = Number of jobs receiving service
- r = Response time or the time in the system
= time waiting + time receiving service
- w = Waiting time
= Time between arrival and beginning of service

Rules for All Queues

Rules: The following apply to $G/G/m$ queues

1. Stability Condition: Arrival rate must be less than service rate
 $\lambda < m\mu$
Finite-population or finite-buffer systems are always stable.
Instability = infinite queue
Sufficient but not necessary. D/D/1 queue is stable at $\lambda = \mu$
2. Number in System versus Number in Queue:
 $n = n_q + n_s$
Notice that n , n_q , and n_s are random variables.
 $E[n] = E[n_q] + E[n_s]$

Rules for All Queues (cont)

3. Number versus Time:
If jobs are not lost due to insufficient buffers,
Mean number of jobs in the system
= Arrival rate \times Mean response time
4. Similarly,
Mean number of jobs in the queue
= Arrival rate \times Mean waiting time

This is known as **Little's law**.

5. Time in System versus Time in Queue

$$r = w + s$$

r , w , and s are random variables.

$$E[r] = E[w] + E[s]$$

Rules for All Queues(cont)

6. If the service rate is independent of the number of jobs in the queue,

$$Cov(w,s)=0$$

$$Var[r] = Var[w] + Var[s]$$

Quiz 30C

- If a queue has 2 jobs waiting for service, the number in system is ____
- If the arrival rate is 2 jobs/second, the mean inter-arrival time is ____ second.
- In a 3 server queue, the jobs arrive at the rate of 1 jobs/second, the service time should be less than ____ second/job for the queue to be stable.

Solution to Quiz 30C

- If a queue has 2 jobs waiting for service, the number in system is m+2.
- If the arrival rate is 2 jobs/second, the mean inter-arrival time is 0.5 second.
- In a 3 server queue, the jobs arrive at the rate of 1 jobs/second, the service time should be less than 3 second/job for the queue to be stable.

Little's Law

- Mean number in the system
= Arrival rate \times Mean response time
- This relationship applies to all systems or parts of systems in which the number of jobs entering the system is equal to those completing service.
- Named after Little (1961)
- Based on a black-box view of the system:

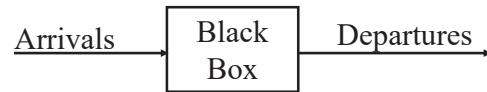

- In systems in which some jobs are lost due to finite buffers, the law can be applied to the part of the system consisting of the waiting and serving positions

Proof of Little's Law

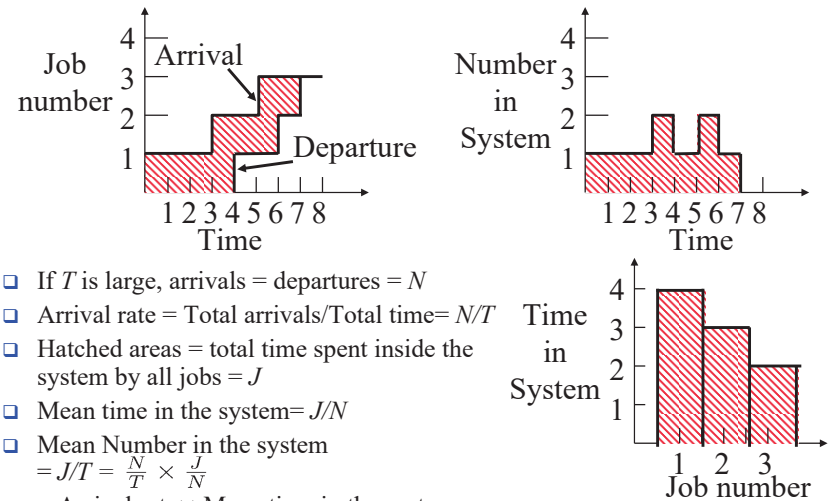

- If T is large, arrivals = departures = N
- Arrival rate = Total arrivals/Total time = N/T
- Hatched areas = total time spent inside the system by all jobs = J
- Mean time in the system = J/N
- Mean Number in the system
= $J/T = \frac{N}{T} \times \frac{J}{N}$
= Arrival rate \times Mean time in the system

Application of Little's Law

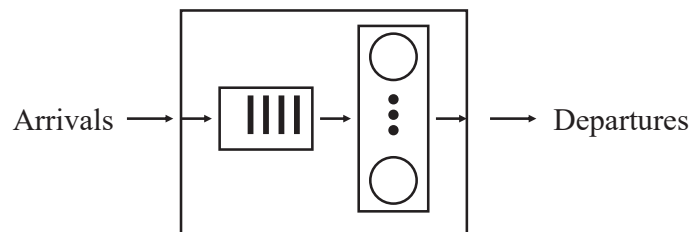

- Applying to just the waiting facility of a service center
- Mean number in the queue = Arrival rate \times Mean waiting time
- Similarly, for those currently receiving the service, we have:
- Mean number in service = Arrival rate \times Mean service time

Example 30.3

- A monitor on a disk server showed that the average time to satisfy an I/O request was 100 milliseconds. The I/O rate was about 100 requests per second. What was the mean number of requests at the disk server?
- Using Little's law:
Mean number in the disk server
= Arrival rate \times Response time
= 100 (requests/second) \times (0.1 seconds)
= 10 requests

Quiz 30D

- ❑ Key: $n = \lambda R$
- ❑ During a 1 minute observation, a server received 120 requests. The mean response time was 1 second. The mean number of queries in the server is _____

Solution to Quiz 30D

- ❑ Key: $n = \lambda R$
- ❑ During a 1 minute observation, a server received 120 requests. The mean response time was 1 second. The mean number of queries in the server is 2.
- ❑ $\lambda = 120/60 = 2$
 $R = 1$
 $n = 2$

Stochastic Processes

- ❑ **Process:** Function of time
- ❑ **Stochastic Process:** Random variables, which are functions of time
- ❑ **Example 1:**
 - $n(t)$ = number of jobs at the CPU
 - Observe $n(t)$ at several identical systems
 - The number $n(t)$ is a random variable.
 - Find the probability distribution functions for $n(t)$ at each t .
- ❑ **Example 2:**
 - $w(t)$ = waiting time in a queue

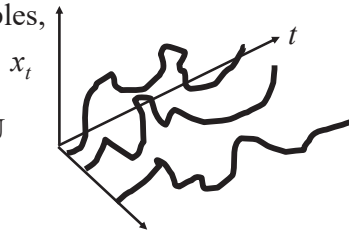

Types of Stochastic Processes

- ❑ Discrete or Continuous State Processes
- ❑ Markov Processes
- ❑ Birth-death Processes
- ❑ Poisson Processes

Discrete/Continuous State Processes

- Discrete = Finite or Countable
- Number of jobs in a system $n(t) = 0, 1, 2, \dots$
- $n(t)$ is a discrete state process
- The waiting time $w(t)$ is a continuous state process.
- **Stochastic Chain**: discrete state stochastic process
- Note: Time can also be discrete or continuous
 \Rightarrow Discrete/continuous **time** processes
 Here we will consider only continuous time processes

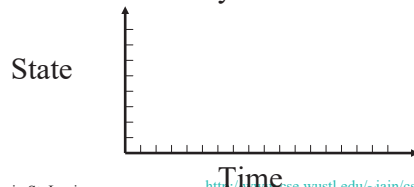

Markov Processes

- Future states are independent of the past and depend only on the present.
- Named after A. A. Markov who defined and analyzed them in 1907.
- **Markov Chain**: discrete state Markov process
- Markov \Rightarrow It is not necessary to history of the previous states of the process \Rightarrow Future depends upon the current state only
- $M/M/m$ queues can be modeled using Markov processes.
- The time spent by a job in such a queue is a Markov process and the number of jobs in the queue is a Markov chain.

Birth-Death Processes

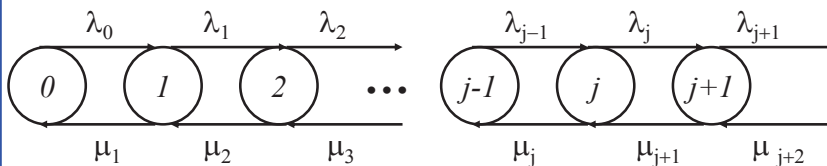

- The discrete space Markov processes in which the transitions are restricted to neighboring states
- Process in state n can change only to state $n+1$ or $n-1$.
- Example: the number of jobs in a queue with a single server and individual arrivals (not bulk arrivals)

Poisson Distribution

- If the inter-arrival times are exponentially distributed, number of arrivals in any given interval are Poisson distributed

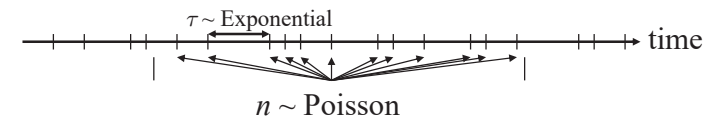

$$f(\tau) = \lambda e^{-\lambda\tau} \quad E[\tau] = \frac{1}{\lambda}$$

$$P(n \text{ arrivals in } t) = (\lambda t)^n \frac{e^{-\lambda t}}{n!} \quad E[n] = \lambda t$$

- M = Memoryless arrival = Poisson arrivals
- Example: $\lambda=4 \Rightarrow$ 4 jobs/sec or 0.25 sec between jobs on average

Poisson Processes

- Interarrival time $s = \text{IID}$ and exponential
 \Rightarrow number of arrivals n over a given interval $(t, t+x)$ has a Poisson distribution
 \Rightarrow arrival = Poisson process or Poisson stream

Properties:

1. Merging: $\lambda = \sum_{i=1}^k \lambda_i$

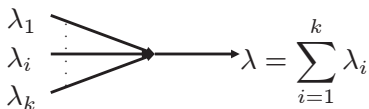

2. Splitting: If the probability of a job going to i th substream is p_i , each substream is also Poisson with a mean rate of $p_i \lambda$

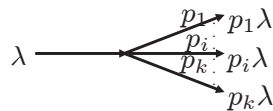

Poisson Processes (Cont)

3. If the arrivals to a single server with exponential service time are Poisson with mean rate λ , the departures are also Poisson with the same rate λ provided $\lambda < \mu$.



Poisson Process(cont)

4. If the arrivals to a service facility with m service centers are Poisson with a mean rate λ , the departures also constitute a Poisson stream with the same rate λ , provided $\lambda < \sum_i \mu_i$. Here, the servers are assumed to have exponentially distributed service times.

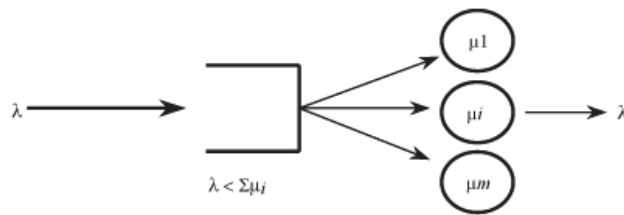

PASTA Property



- Poisson Arrivals See Time Averages
 - Poisson arrivals \Rightarrow Random arrivals from a large number of independent sources
 - If an external observer samples a system at a random instant:
 $P(\text{System state} = x) = P(\text{State as seen by a Poisson arrival is } x)$
- Example: D/D/1 Queue: Arrivals = 1 job/sec, Service = 2 jobs/sec

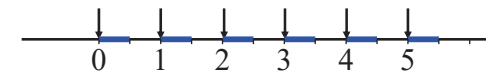

All customers see an empty system.

- M/D/1 Queue: Arrivals = 1 job/sec (avg), Service = 2 jobs/sec
 Randomly sample the system. System is busy half of the time.

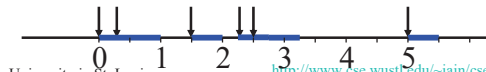

Relationship Among Stochastic Processes

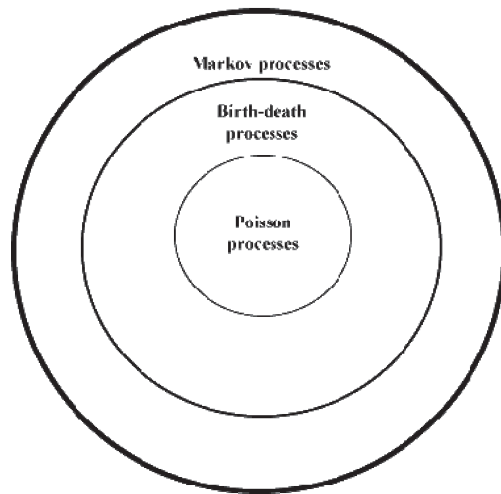

Quiz 30E

- T F** Birth-death process can have bulk service
- Merger of Poisson processes results in a _____ Process
- The number of jobs in a M/M/1 queue is Markov _____
- T F** A discrete time process is also called a chain

Solution to Quiz 30E

- T F** Birth-death process can have bulk service
- Merger of Poisson processes results in a **Poisson** Process
- The number of jobs in a M/M/1 queue is Markov **Chain**
- T F** A discrete time process is also called a chain

Summary

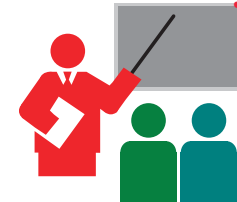

- Kendall Notation: A/S/m/B/k/SD, M/M/1
- Number in system, queue, waiting, service
Service rate, arrival rate, response time, waiting time, service time
- Little's Law:
Mean number in system = Arrival rate \times Mean time in system
- Processes: Markov \Rightarrow Only one state required,
Birth-death \Rightarrow Adjacent states
Poisson \Rightarrow IID and exponential inter-arrival

Homework 30

- Updated Exercise 30.4
During a one-hour observation interval, the name server of a distributed system received 12,960 requests. The mean response time of these requests was observed to be one-third of a second.
 - a. What is the mean number of queries in the server?
 - b. What assumptions have you made about the system?
 - c. Would the mean number of queries be different if the service time was not exponentially distributed?

Reading List

- If you need to refresh your probability concepts, read chapter 12
- Read Chapter 30
- Refer to Chapter 29 for various distributions





Scan This to Download These Slides



Raj Jain

<http://rajjain.com>

Related Modules

-  CSE567M: Computer Systems Analysis (Spring 2013),
https://www.youtube.com/playlist?list=PLjGG94etKypJEKjNAa1n_1X0bWWNyZcof
-  CSE473S: Introduction to Computer Networks (Fall 2011),
https://www.youtube.com/playlist?list=PLjGG94etKypJWOSPm8Azcg5e_10TiDw
-  Wireless and Mobile Networking (Spring 2016),
https://www.youtube.com/playlist?list=PLjGG94etKypKeb0nzyN9tSs_HCd5c4wXF
-  CSE571S: Network Security (Fall 2011),
<https://www.youtube.com/playlist?list=PLjGG94etKypKvzfVtutHcPFJXumyyg93u>
-  Video Podcasts of Prof. Raj Jain's Lectures,
<https://www.youtube.com/channel/UCN4-5wzNP9-ruOzQM8-8NUw>