

# Computer Networks and the Internet

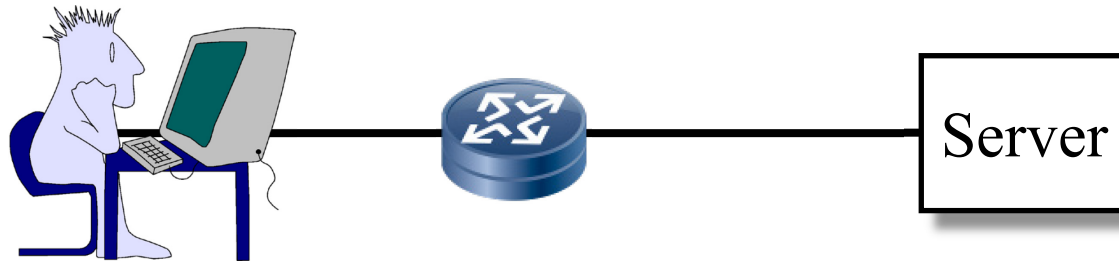

**Raj Jain**

Washington University in Saint Louis

Saint Louis, MO 63130

Jain@wustl.edu

Audio/Video recordings of this lecture are available on-line at:

<http://www.cse.wustl.edu/~jain/cse473-23/>

## Student Questions

- ❑ Can you provide the slides (ppt or pdf) since it's convenient to take notes directly on them? *Yes. All slides are on the course website. URL is on every slide.*
- ❖ This symbol precedes questions asked during the Exam 1 Review session.



1. What is Internet?
2. Switching: Circuit vs. Packet
3. Edge vs. Core
4. Network Performance Measures: Delay, Loss, Throughput
5. Protocol Layers
6. Network Security
7. History

**Note:** This class lecture is based on Chapter 1 of the textbook (Kurose and Ross) and the slides provided by the authors.

## Student Questions

- ❑ Are we required to read the textbook?  
*Yes. After watching the video. Maybe after the Q&A session when the video is completely understood. You can ask additional questions anytime.*
- ❑ Since Chapter 1 is a broad overview, will we be required to know about every layer at a surface level? Or what is the extent of knowledge for chapter 1? It seems like it discusses mainly the physical layer.  
*Yes, Chapter 1 discusses the topics listed on this slide. You need to know things at this level of detail. For example, you should know what layer 3 (IP) does, but you may not know how it does it.*

---

❖ Where are we supposed to take the exam (location)?

*Lopata Hall 101*

# What is a Network?

- ❑ **Network:** Enables data transfer among nodes
  - Generally heterogeneous nodes
  - More than **two** nodes
  - E.g., Your home or office network

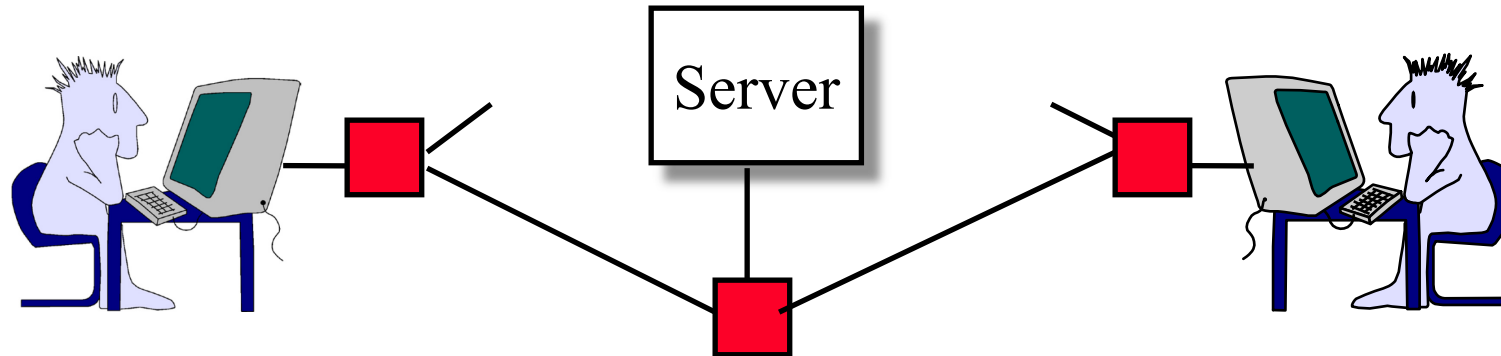

- ❑ **Communication:** Two nodes.
  - Link-level electrical issues.



## Student Questions

- ❑ Can multiple nodes exist in one physical device? If so, can we treat one physical device with various nodes as a network?  
*Yes. Yes.*
  - ❑ What are heterogeneous nodes?  
*Homogeneous=Similar*  
*Heterogeneous=It may not be similar.*
  - ❑ What are nodes? Is it a point where a connection is established between two points? *A node is any device connected to the network.*
- 
- ❑ How are nodes defined in this context? *See above.*
  - ❑ Can we view a network as a collection of communications?  
*Interconnection of communication links*
  - ❑ What do heterogeneous nodes mean?  
*See above...*

# Key Concepts



- ❑ **End Systems:** Systems that are sinks or sources of data, e.g., Desktops, Laptops, Servers, Printers, Cell Phones, etc.
- ❑ **Intermediate Systems:** Systems that forward/switch data from one link to another, e.g., routers, switches
- ❑ **Hosts:** End Systems
- ❑ **Gateways:** Routers
- ❑ **Servers:** End Systems that provide service, e.g., print server, storage server, Mail server, etc.
- ❑ **Clients:** End systems that request service
- ❑ **Links:** Connect the systems.  
Characterized by transmission rate, propagation delay

## Student Questions

- ❑ Could an intermediate system be considered a link? *Link is usually a medium, e.g., wire or radio, or light.*
- ❑ Could the service of linking two nodes characterize a system as a server? *Not necessarily. A router is an intermediate system. Even though they are providing the routing service, we don't typically call them servers, particularly since they are invisible.*
- ❑ Are there end systems that don't request service? (e.g., non-clients)

*Yes, some end systems, e.g., sensors, provide service. Some monitor the network. Etc.*

- ❑ So the servers could be called host, and a client could also be called host? *Yes.*
- ❑ What specifically do routers do? *Routers forward packets*
- ❑ How do we distinguish between intermediates and links? *Systems can store and forward packets. Links simply pass the bits from one end to another, like houses vs. roads.*

# Key Concepts



- ❑ **End Systems:** Systems that are sinks or sources of data, e.g., Desktops, Laptops, Servers, Printers, Cell Phones, etc.
- ❑ **Intermediate Systems:** Systems that forward/switch data from one link to another, e.g., routers, switches
- ❑ **Hosts:** End Systems
- ❑ **Gateways:** Routers
- ❑ **Servers:** End Systems that provide service, e.g., print server, storage server, Mail server, etc.
- ❑ **Clients:** End systems that request service
- ❑ **Links:** Connect the systems.  
Characterized by transmission rate, propagation delay

## Student Questions

- ❑ What is the difference between hosts and servers?

*Hosts=Nodes*

*Types of Node: Servers and Clients*

- ❑ Is Gateway included in the Intermediate system?

*Yes.*

- ❑ What is the difference between a router and a switch?

*It will be clear after we cover the protocol layers.*

- ❑ If I transmit data to the server, and then the server transmits data to another computer, is the server an End System or an Intermediate System?

*It is an end system since its primary function is not forwarding.*

# Key Concepts

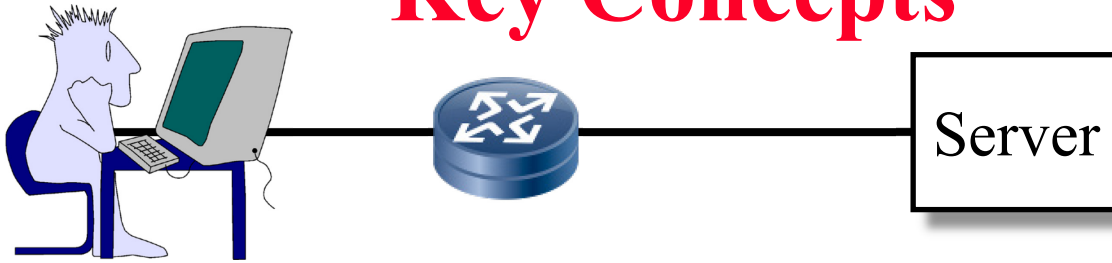

- ❑ **End Systems:** Systems that are sinks or sources of data, e.g., Desktops, Laptops, Servers, Printers, Cell Phones, etc.
- ❑ **Intermediate Systems:** Systems that forward/switch data from one link to another, e.g., routers, switches
- ❑ **Hosts:** End Systems
- ❑ **Gateways:** Routers
- ❑ **Servers:** End Systems that provide service, e.g., print server, storage server, Mail server, etc.
- ❑ **Clients:** End systems that request service
- ❑ **Links:** Connect the systems.  
Characterized by transmission rate, propagation delay

## Student Questions

- ❑ What are some gateways examples before we use Wi-Fi and routers?

### *Routers*

- ❖ What is the difference between routers and switches?

*Routers: Layer 3 devices (speak IPv4, IPv6, ...)*

*Switches: Layer 2 devices (speak Ethernet, WiFi, ...)*

# What is Internet?

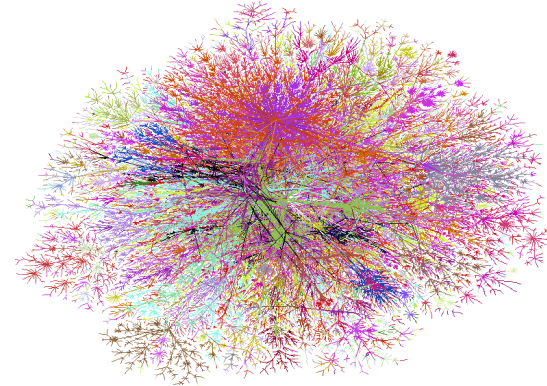
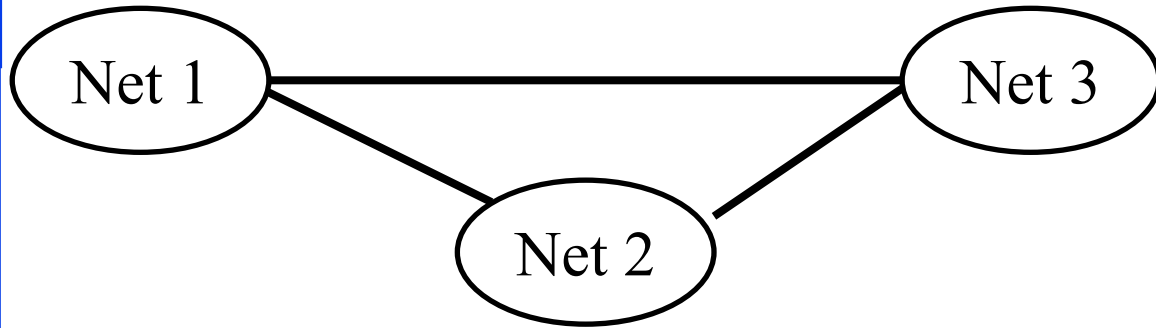

- ❑ Internet = Inter-Network = Network connecting networks
- ❑ Approximately 1.05B hosts on the Internet in 2016.
- ❑ ISP: **Internet Service Provider**.
  - Provide access to the Internet.
  - Telecommunications (Telephone) Companies, AT&T, Verizon, Comcast, ...
  - Coffee Shops (Wi-Fi)

## Student Questions

- ❑ Why are coffee shops considered ISP?  
*They provide Internet service.*
  - ❑ What makes phone calls become free?  
*The Internet is basically free.*
  - ❑ Do ISPs have levels? (Maybe it is the Tier mentioned later in the lecture). For example, if the coffee shops are using AT&T, but I am using Wi-Fi provided by the coffee shops, which is my ISP?  
*Your ISP is the coffee shop.*
  - ❑ Since the Internet is, from what I understand, a network of networks, what would the links between each network be in this case, and could it be possible that a network would serve as the link between 2 other networks? *Yes. Two networks can be connected by one link or more than one link (network).*
- 
- ❑ Can one host be connected to another via the Internet?  
*Yes, that's what the Internet does.*

Ref: <http://www.statista.com/statistics/264473/number-of-internet-hosts-in-the-domain-name-system/>

Washington University in St. Louis

<http://www.cse.wustl.edu/~jain/cse473-23/>

©2023 Raj Jain

# What is Internet?

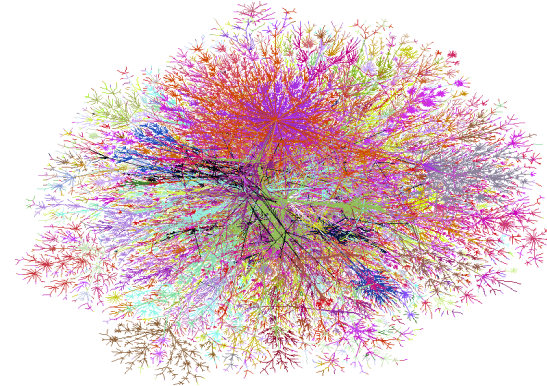
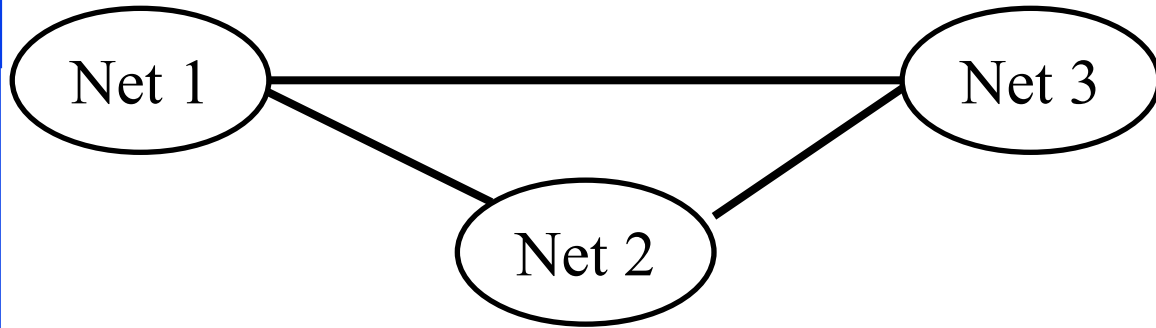

- ❑ Internet = Inter-Network = Network connecting networks
- ❑ Approximately 1.05B hosts on the Internet in 2016.
- ❑ ISP: **Internet Service Provider**.
  - Provide access to the Internet.
  - Telecommunications (Telephone) Companies, AT&T, Verizon, Comcast, ...
  - Coffee Shops (Wi-Fi)

## Student Questions

- ❑ How do ISPs connect all these networks to one another?  
*There are levels (tiers) of ISP. Tier 3 is connected by Tier 2. Tier 2 is connected by Tier 1. To be covered shortly.*
- ❑ Why could a coffee shop be an ISP? Shouldn't it be the telecommunication company that sets up the connection to the coffee shop?  
*The telecommunication company is ISP for the coffee shop.*

Ref: <http://www.statista.com/statistics/264473/number-of-internet-hosts-in-the-domain-name-system/>

Washington University in St. Louis

<http://www.cse.wustl.edu/~jain/cse473-23/>

©2023 Raj Jain



# Types of Networks

## Point to point vs. Broadcast

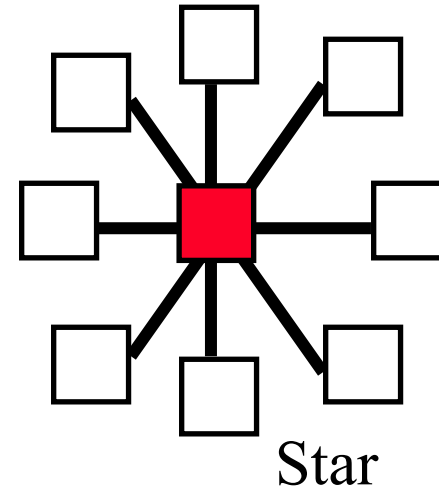
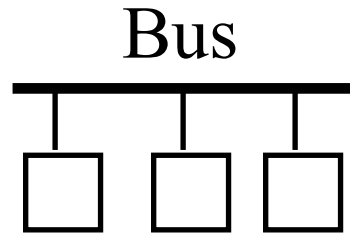
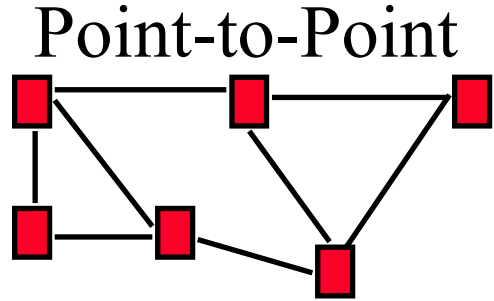

## Circuit-switched vs. packet-switched.

**Circuit:** A path (circuit) is set up before transmission. All bits follow the same path, e.g., the Phone

**Packet:** Packets of bits are forwarded individually

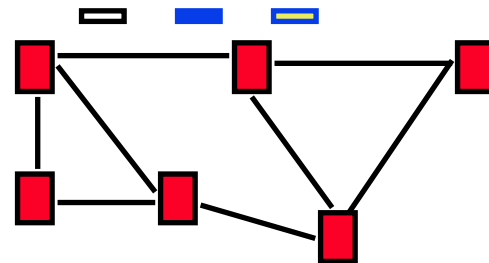
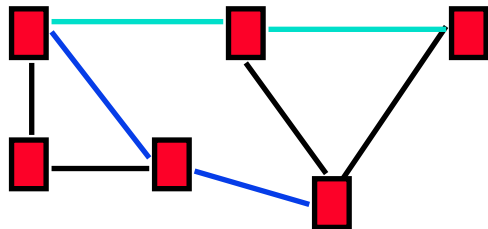

## Student Questions

- ❑ In what cases, if any, are circuit-switched networks used? *Phone network*
- ❑ Can wireless connections only use packet-switching? Therefore, is circuit-switching not as prevalent?

*Wireless can use both circuit and packet switching. Circuit-switched networks exist but are less prevalent.*

- ❑ Did this mean that a circuit can be bidirectional, and a packet is unidirectional?

*Both can be bidirectional or unidirectional.*

- ❑ Is a circuit (path) always physical?

*No. There are virtual circuits.*

- ❑ How does the packet know the address of where to go if the connection has not been set up beforehand, like the circuit?

*The address is put on the packet by the sender.*

- ❑ What would an example of a star network type be? *Your home Ethernet or Wi-Fi.*

- ❑ Is it possible to combine the types of networks? For example, use a star network as the base where each node that extends from the center is a bus network itself.

*Yes.*

# Types of Networks

## Point to point vs. Broadcast

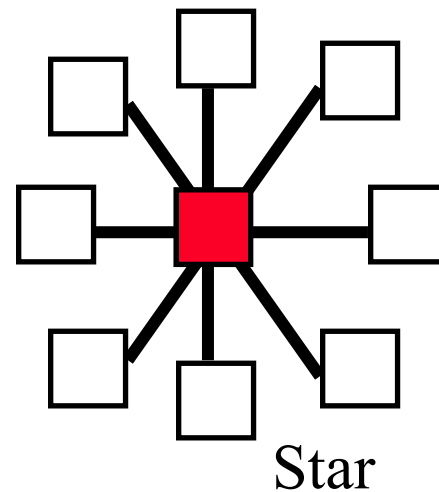
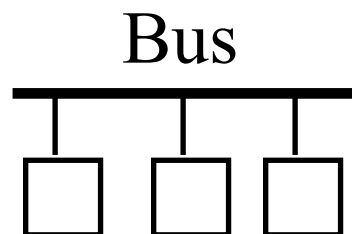
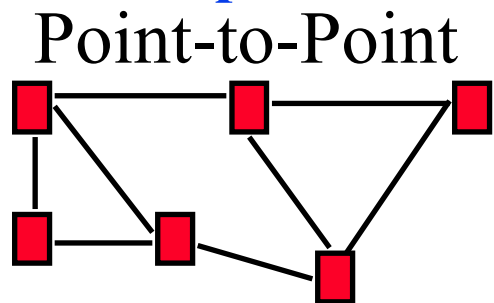

## Circuit-switched vs. packet-switched.

**Circuit:** A path (circuit) is set up before transmission. All bits follow the same path, e.g., the Phone.

**Packet:** Packets of bits are forwarded individually

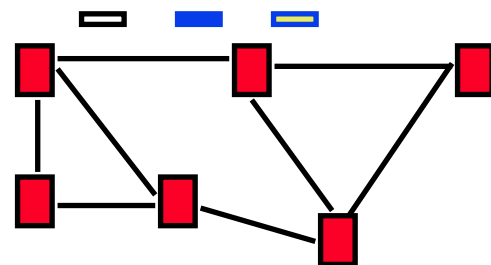
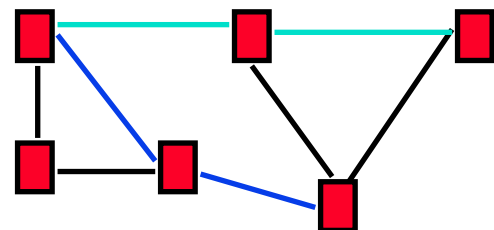

## Student Questions

❑ Do each 2 nodes have a link in Point-to-Point networks?

*Each node should have at least one link. Every pair of nodes may not have a direct link.*

❑ Would a point-to-point network be inefficient in the sense that it requires every node to be connected to every other node, effectively creating/maintaining a very large number of connections per node?

*Point-to-point does not require "full mesh."*

❑ What happens when more than one node broadcasts a message on the bus network? Is there a clash if they are going in opposite directions? How is it resolved?

*Yes. There are collisions. There are protocols to take care of it.*

# Types of Networks

## Point to point vs. Broadcast

Point-to-Point

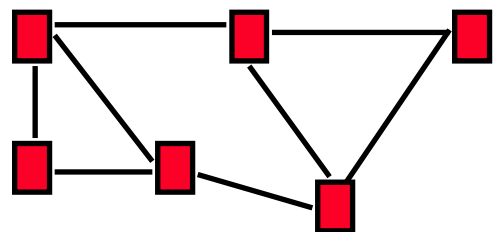

Bus

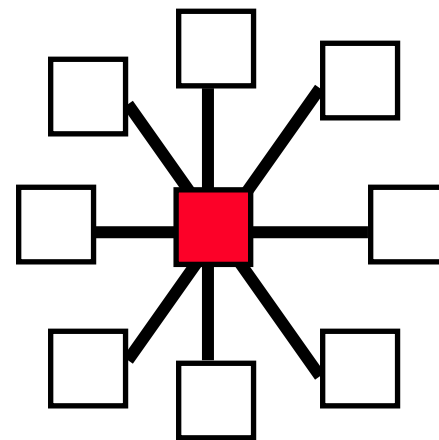
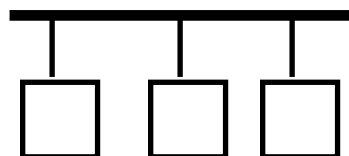

Star

## Circuit switched vs. packet switched

**Circuit:** A path (circuit) is setup before transmission.  
All bits follow the same path, e.g., Phone

**Packet:** Packets of bits are forwarded individually

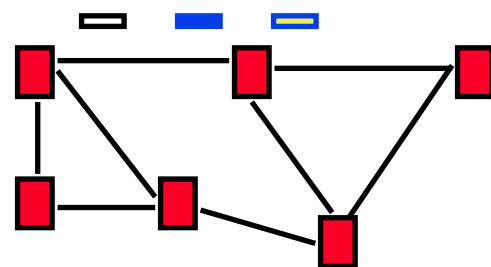
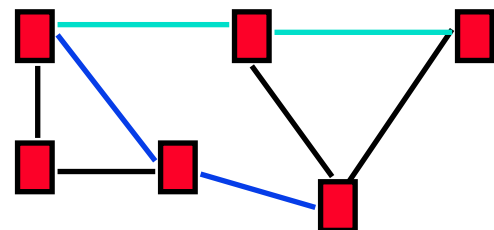

## Student Questions

❑ I don't quite understand the difference between point-to-point and switches since they look almost the same. And you said 99.9% use a star as the pattern. Does that mean the switch is the updated version of a star pattern?

*Switches may be centers of stars. But, switches may be connected to other switches in any topology.*

❑ What's the center of a star network?  
Must it be a router or server?

*Router or a switch*

❑ Is the star network considered point-to-point? *Yes*

❑ Do landline phones still use circuit connections, or are those VoIP also?

*Depends on the provider.*

❑ Is the coaxial connection circuit switched or packet switched?

*It could be either. Coaxial=wire.*

# Types of Networks

## Point to point vs. Broadcast

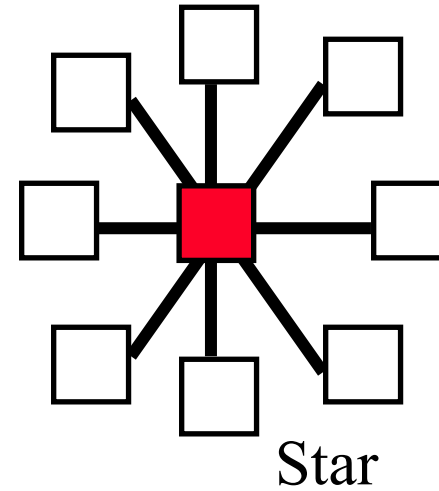
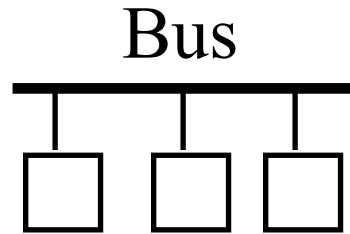
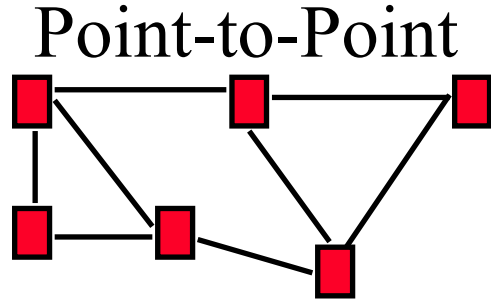

## Circuit switched vs. packet switched

**Circuit:** A path (circuit) is setup before transmission. All bits follow the same path, e.g., Phone

**Packet:** Packets of bits are forwarded individually

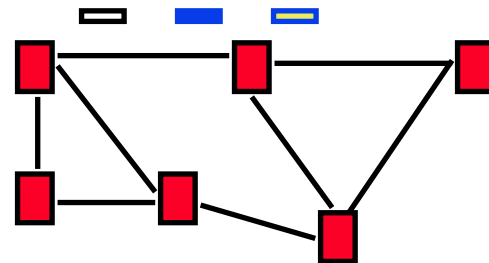
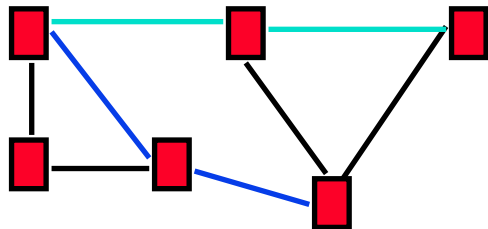

## Student Questions

- Suppose the network is a star. When it broadcasts, if I set my device id as another one's, does it mean my device can 'steal' another device's data?

*Most routers and switches will not allow that without an administrative override.*

- What advantage does a star have compared to a bus?

*Easier to maintain since star point is in a closet and not all over.*

- Why would we ever use a Star network in the manner where the central node sends messages out to everyone? Isn't that just a Bus, but with added resources and likely latency? *Star is easier to maintain.*

# Types of Networks

## Point to point vs. Broadcast

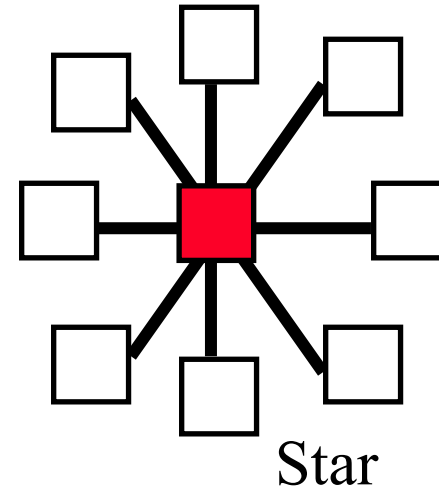
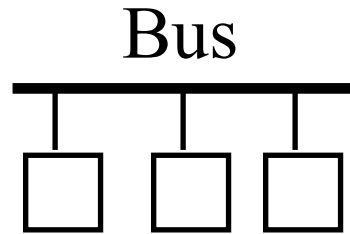
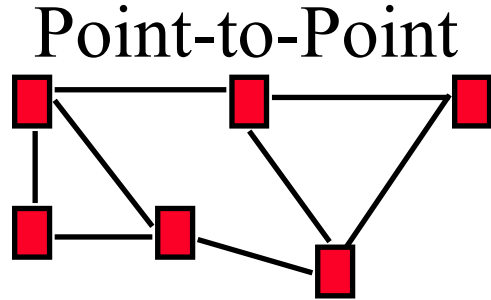

## Circuit switched vs. packet switched

**Circuit:** A path (circuit) is setup before transmission.  
All bits follow the same path, e.g., Phone

**Packet:** Packets of bits are forwarded individually

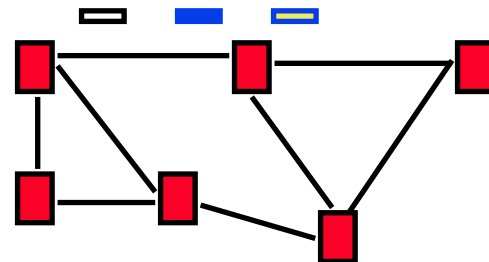
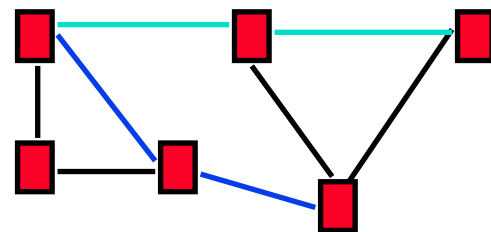

## Student Questions

What is the difference between a point-to-point network and a Star network?

*Point-to-point is more general.*

What is considered Broadcast?

*Everyone can hear it.*

So, in this broadcast case, Is only the machine that receives the data called End System, or can all machines be called the End System?

*End = Primary job is not forwarding.*

How do packets find the correct address?

*Layer 3 is to be covered in Chapter 4.*

# Types of Networks

## Point to point vs. Broadcast

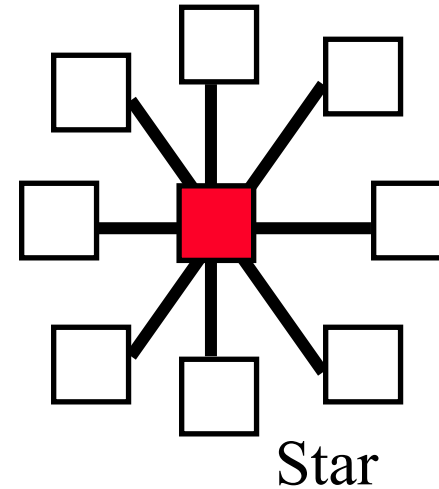
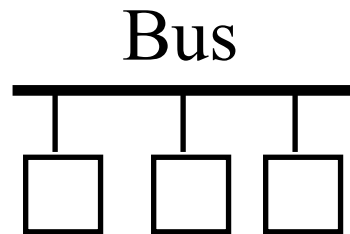
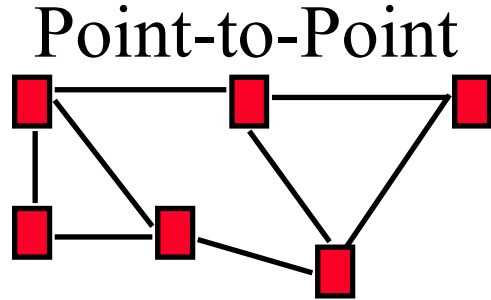

## Circuit switched vs. packet switched

**Circuit:** A path (circuit) is setup before transmission.  
All bits follow the same path, e.g., Phone

**Packet:** Packets of bits are forwarded individually

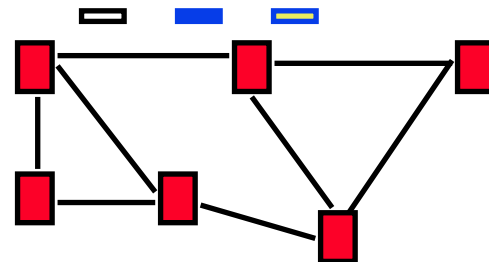
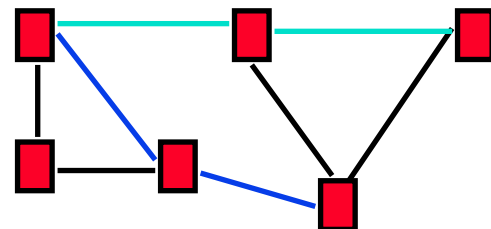

## Student Questions

- ❑ What would be an example of point-to-point networking?
- ❑ *If you have a switch/router, that's a star network.*
- ❑ Does anyone use point-to-point networking now, as opposed to star networking?

*Yes, inter-carrier networks may use point-to-point.*

- ❑ Is each packet transferred via different routes? May the second packet arrive earlier than the first one?

*Yes*

- ❑ Do the star network branches have many points? To make the star with many out layers.

*The question needs to be clarified.*

*You can have a star of stars.*

# Types of Networks

## □ Point to point vs. Broadcast

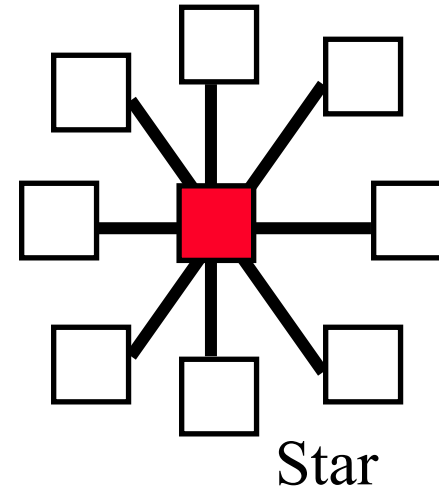
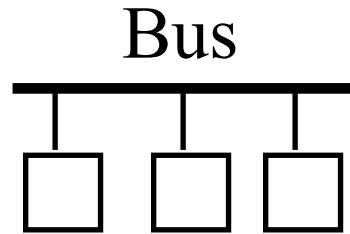
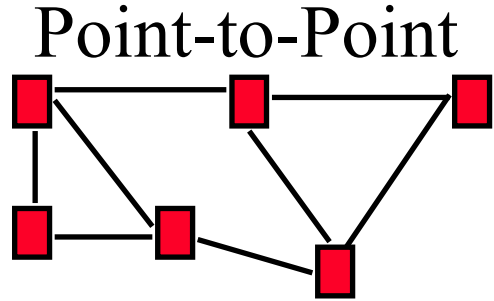

## □ Circuit switched vs. packet switched

□ **Circuit:** A path (circuit) is setup before transmission. All bits follow the same path, e.g., Phone

□ **Packet:** Packets of bits are forwarded individually

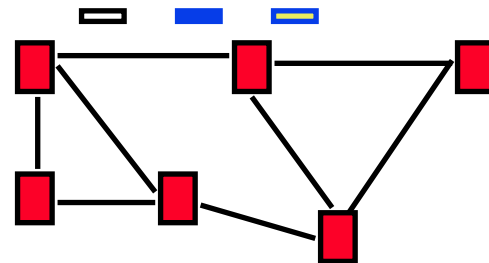
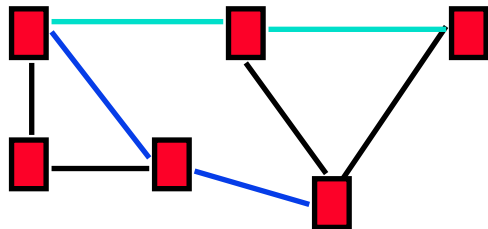

## Student Questions

□ Can we have some examples of the use of different networks?

*Star=With Switches and routers (most common)*

*Point-to-Point without star: Inter-carrier*

*Bus=Original Ethernet in the 1980s*

❖ Can Star network be viewed as Point-to-Point network?

*Yes.*

❖ When we establish an end-to-end system, does the total transmission time depends on the number of links in this system?

*No, the transmission time at each node in the path is determined by the link it is transmitting on. Total delay depends on queuing delays, transmission time, and propagation times.*



# Multiplexing

- ❑ How can multiple users share a link?
- ❑ **Time Division Multiplexing (TDM)**

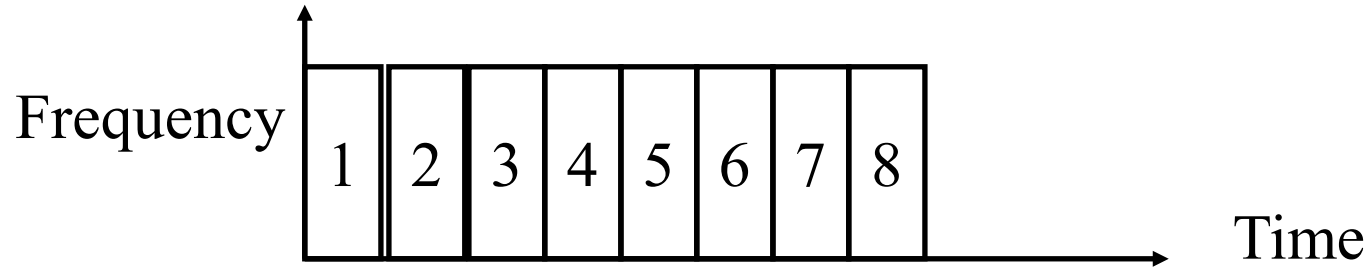

- ❑ **Frequency Division Multiplexing (FDM)**

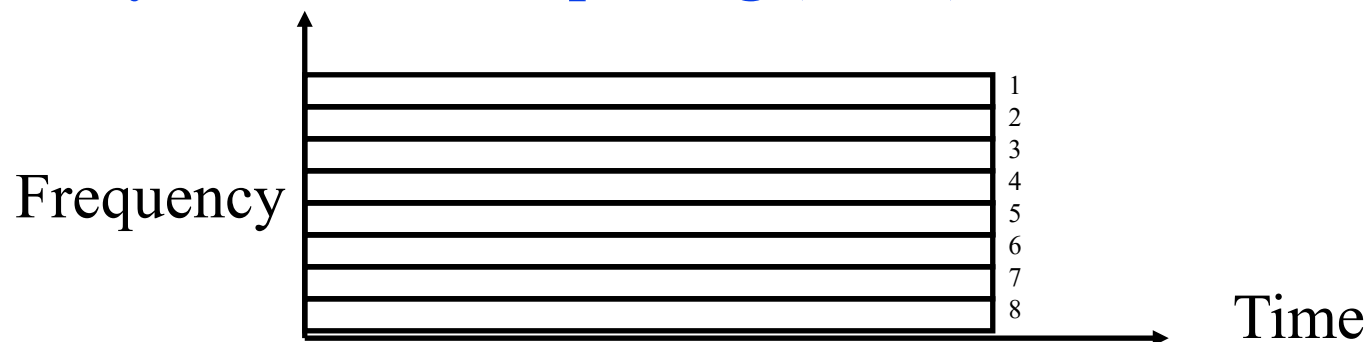

- ❑ Other multiplexing methods will be covered as needed.

## Student Questions

- ❑ Which multiplexing methods are more popular nowadays? *Both. Plus a few others.*
- ❑ Is FDM more efficient compared to TDM since if we have a lot of clients and we use TDM, the delay a client receives grows linearly with the number of clients?  
*No. There are many considerations-- Scalability, burstiness of usage, etc.*
- ❑ Did dial-up networks not use multiplexing? (Since you could not use the internet and phone at the same time).  
*They multiplexed many users on the same trunk line.*
- ❑ Is multiplexing only used in the circuit-switched? *TDM is also multiplexing.*
- ❑ Why would one multiplexing method (TDM/FDM) be preferable/used over the other? *Scalability, efficiency,*
- ❑ In a circuit-switched network, does information still need to be divided into multiple packets? *It is not necessary, but you can.*





# Multiplexing

- ❑ How can multiple users share a link?
- ❑ **Time Division Multiplexing (TDM)**

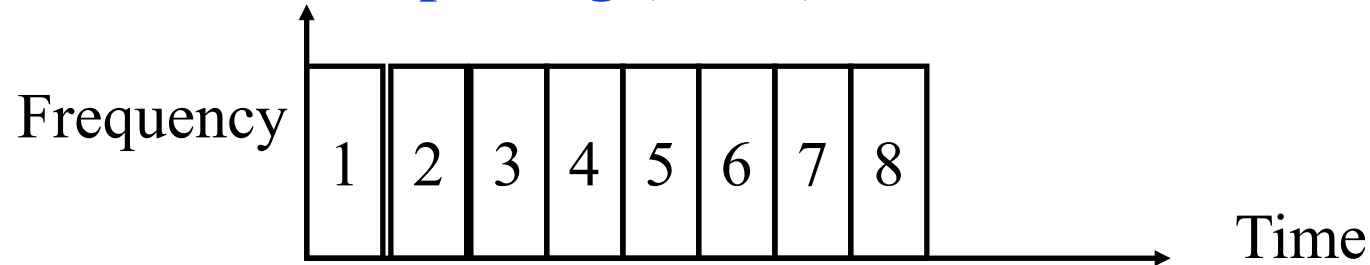

- ❑ **Frequency Division Multiplexing (FDM)**

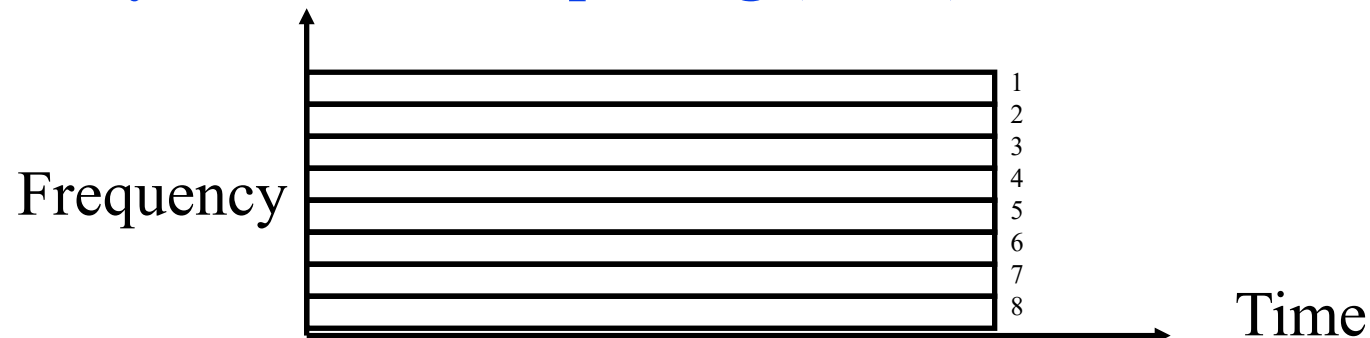

- ❑ Other multiplexing methods will be covered as needed.

## Student Questions

- ❑ Are there limitations to what style of multiplexing one can use based on the type of network associated?  
*Yes. But you can virtualize and provide any type of service over any time of the network.*
- ❑ Is there a mixed pattern between TDM and FDM? *Yes.*
- ❑ Was ethernet TDM because it is a bus network? Is it still TDM, even though it is used in star networks? *Yes. Ethernet is still TDM.*
- ❑ Is multiplexing used to handle the problem that several connections share the same link? How can we guarantee connections do not interfere with each other? Is multiplexing only happening in the circuit-switched?  
*No TDM is multiplexing. Proper resource allocation can prevent interference.*
- ❑ What is the disadvantage of FDM?  
*Allocated but not used can be wasted.*
- ❑ Is using TDMA somewhat like TDM?  
*TDMA=TDM Access*

- ❑ Are multiplexing methods restricted by the medium (copper, wireless, etc.)?  
*Yes, sometimes.*



# Multiplexing

- ❑ How can multiple users share a link?
- ❑ **Time Division Multiplexing (TDM)**

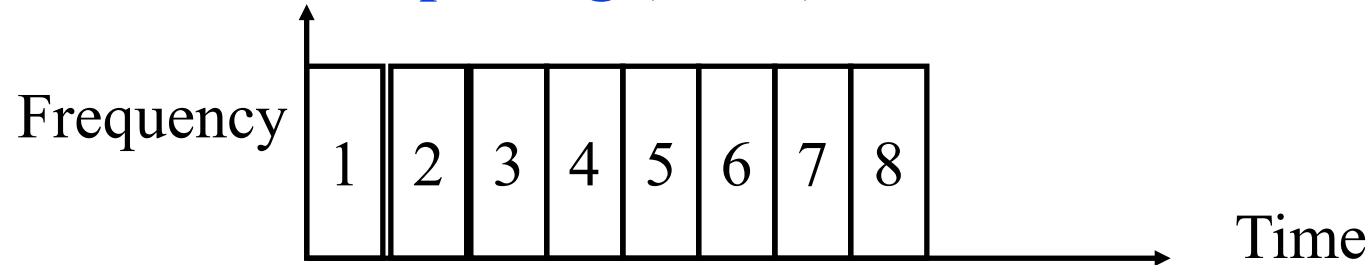

- ❑ **Frequency Division Multiplexing (FDM)**

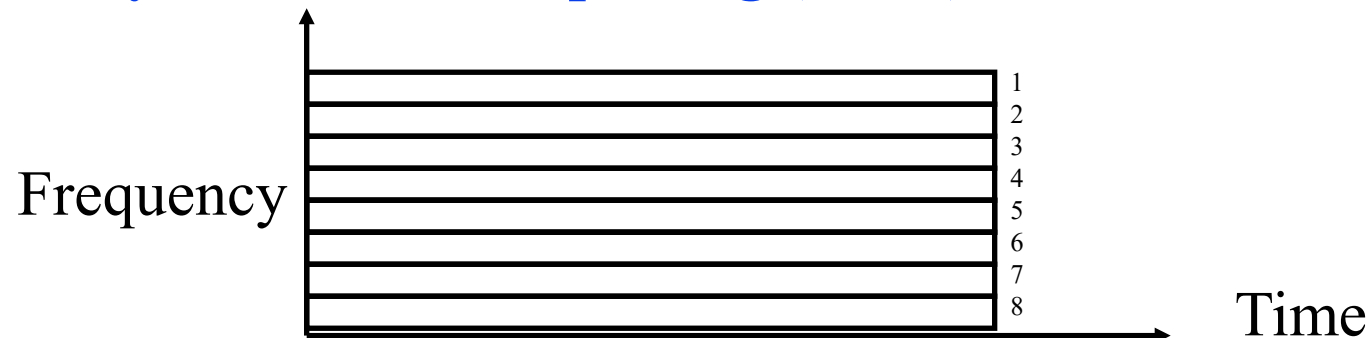

- ❑ Other multiplexing methods will be covered as needed.

## Student Questions

- ❑ Are there any situations in which TDM is more advantageous than FDM? What are these scenarios?  
*Bursty traffic is better handled by TDM.*
- ❑ How frequency division multiplexing applies to wired connection links. I didn't think copper could have a frequency band.  
*Copper has a frequency band.*
- ❑ With TDM, how small can divisions of time get? Would they be on the scale of seconds, fractions of seconds?  
*Milliseconds*

# Types of Networks (Cont)

- ❑ **Local Area Networks (LAN):** 0-2 km, Single Ownership
- Metropolitan Area Networks (MAN)** 2-50 km,
- Wide Area Networks (WAN)** 50+ km
  - Originally LAN/MAN/WAN technologies were different
  - Now they are all the same
- ❑ Telecom Networks:
  - **Access:** Between the subscriber and the service provider
  - **Metro:** Covering a city
  - **Core:** Between cities

## Student Questions

- ❑ Why did LAN, MAN, and WAN become the same? *We could design technologies that work at all distances.*
- ❑ Why are the telecom networks between cities called cores? *Terminology.*
- ❑ Is MAN still in use these days?  
*Yes, 4G and 5G are MAN.*

- 
- ❑ When you say it is now all the same for LAN, MAN, and WAN, do you mean their functionalities or their technologies?

### *Technology*

- ❑ How are the technologies used for LAN/MAN/WAN different from each other? *Different distances require different protocols. Broadcast good only for small areas.*

# Types of Networks (Cont)

- ❑ **Local Area Networks (LAN):** 0-2 km, Single Ownership
- Metropolitan Area Networks (MAN)** 2-50 km,
- Wide Area Networks (WAN)** 50+ km
  - Originally LAN/MAN/WAN technologies were different
  - Now they are all the same
- ❑ Telecom Networks:
  - **Access:** Between the subscriber and the service provider
  - **Metro:** Covering a city
  - **Core:** Between cities

## Student Questions

- ❑ Why did LAN, MAN, and WAN become the same? *We could design technologies that work at all distances.*
  - ❑ Why are the telecom networks between cities called cores? *Terminology.*
  - ❑ Is MAN still in use these days?  
*Yes, 4G and 5G are MAN.*
- 
- ❑ How are LAN, MAN, and WAN technologies the same now?  
*Ethernet has been extended to meet all requirements.*

# Structure of the Internet

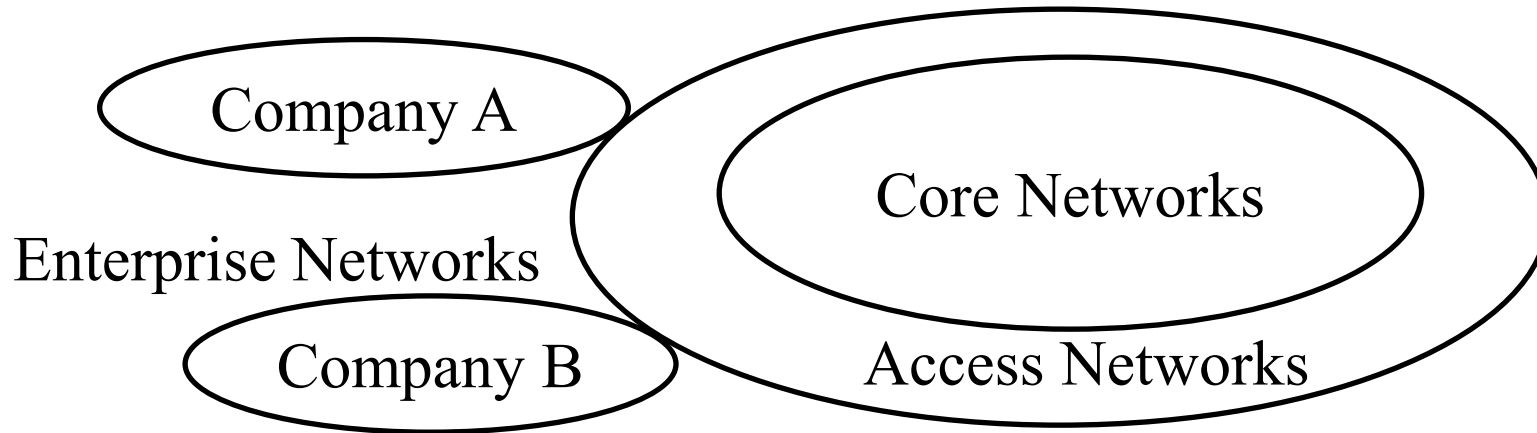

- ❑ Enterprise/Home Networks: **Stub** Networks.  
Privately owned  $\Rightarrow$  Not owned by ISP  
e.g., WUSTL network: Ethernet and WiFi
- ❑ **Access** Network: Enterprise/Users to ISP (in the city)  
WiFi, 3G/4G, DSL
- ❑ **Core** Network: ISP's network (between city): Optical Fiber

## Student Questions

- ❑ Why this diagram depicts core networks as a subset of access networks? *This is not a Venn diagram.*
- ❑ Why the access networks circle is bigger than the core networks. *Access is on the edges of the core. Access connects to customers and is everywhere.*  
*The airplanes owned by FedEx/ Amazon/UPS are their core transports.*

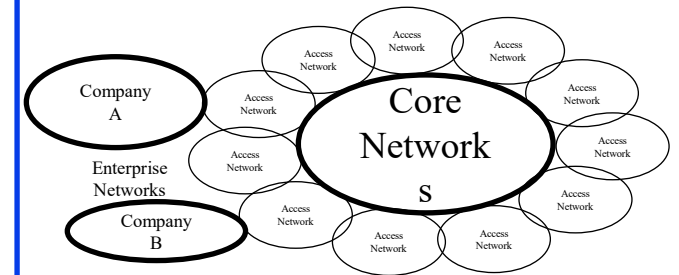

- ❑ What are stub networks? *They don't allow other companies' packets to go through.*
- ❑ Does Core Network mean only between networks of one ISP?  
*No. A core can connect multiple ISPs.*

# Structure of the Internet

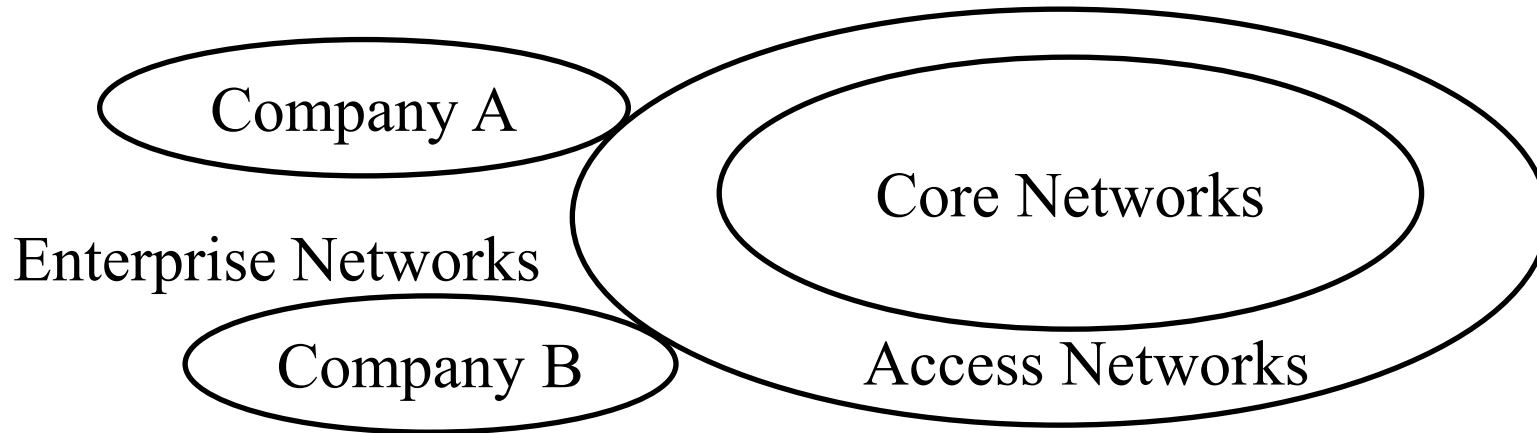

- ❑ Enterprise/Home Networks: **Stub** Networks.  
Privately owned  $\Rightarrow$  Not owned by ISP  
e.g., WUSTL network: Ethernet and WiFi
- ❑ **Access** Network: Enterprise/Users to ISP (in the city)  
WiFi, 3G/4G, DSL
- ❑ **Core** Network: ISP's network (between city): Optical Fiber

## Student Questions

- ❑ Since stub networks are not owned by ISP, how do they provide Internet? As I remember, ISP provides Internet. Does this mean stub networks are ISP themselves?  
*No. Stub networks are clients. They do not provide Internet to anyone outside. For example, WUSTL is a stub network.*

- ❑ Do private enterprise networks with no connection to the larger internet exist? If so, what is their primary use?

*WUSTL is a private enterprise network.*

- ❑ Could you explain this diagram? What does it mean that companies A and B are adjacent to access networks?

*Access = Carrier to the customer*

# Structure of the Internet

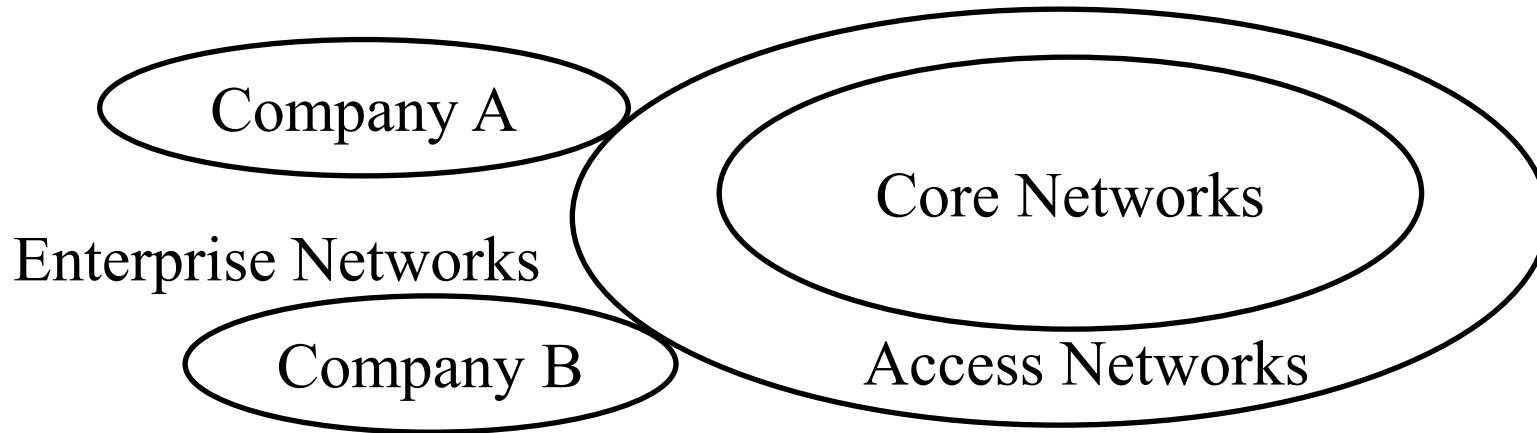

- ❑ Enterprise/Home Networks: **Stub** Networks.  
Privately owned ⇒ Not owned by ISP  
e.g., WUSTL network: Ethernet and WiFi
- ❑ **Access** Network: Enterprise/Users to ISP (in the city)  
WiFi, 3G/4G, DSL
- ❑ **Core** Network: ISP's network (between city): Optical Fiber

## Student Questions

- ❖ Chapter 1, page 12. The textbook defines an access network as: "the network that physically connects an end system to the first router (also known as the "edge router") on a path from the end system to any other distant end system." However, on the graph below this definition, two routers are on the path from the Home network to the local ISP. Why is the second router considered the "edge router"?

*The first router is part of the home network. ISP starts with the edge router.*

# Structure of the Internet

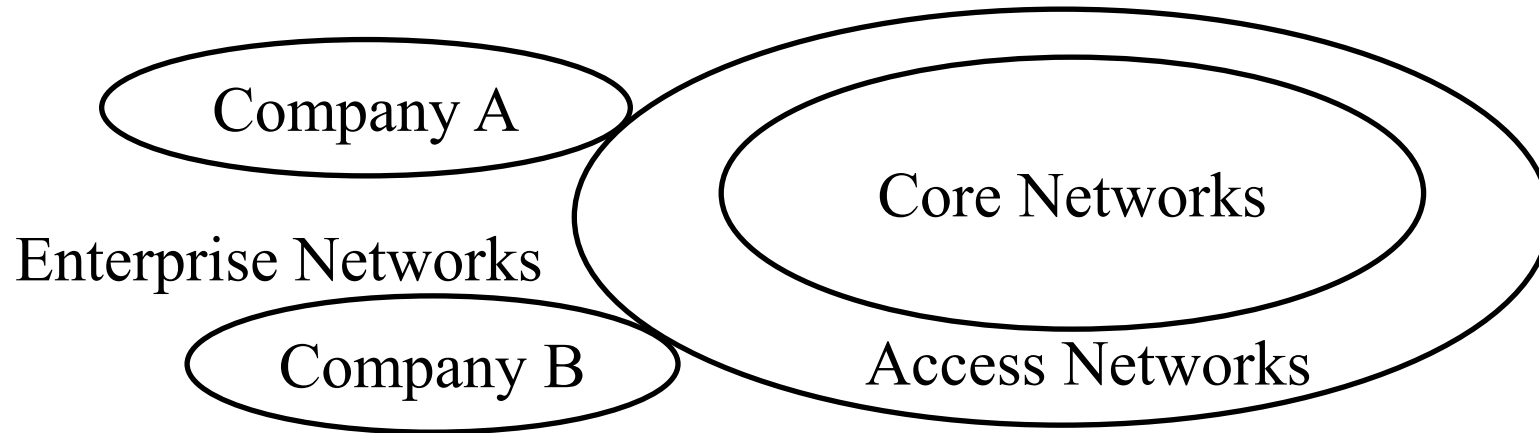

- ❑ Enterprise/Home Networks: **Stub** Networks.  
Privately owned ⇒ Not owned by ISP  
e.g., WUSTL network: Ethernet and WiFi
- ❑ **Access** Network: Enterprise/Users to ISP (in the city)  
WiFi, 3G/4G, DSL
- ❑ **Core** Network: ISP's network (between city): Optical Fiber

## Student Questions

- ❖ Is it right to say that 'enterprise networks are connected to the core network via access network?

*Core and access are differentiated by the carrier not by the customer. So the customers really connect to the access network.*



# Types of ISPs

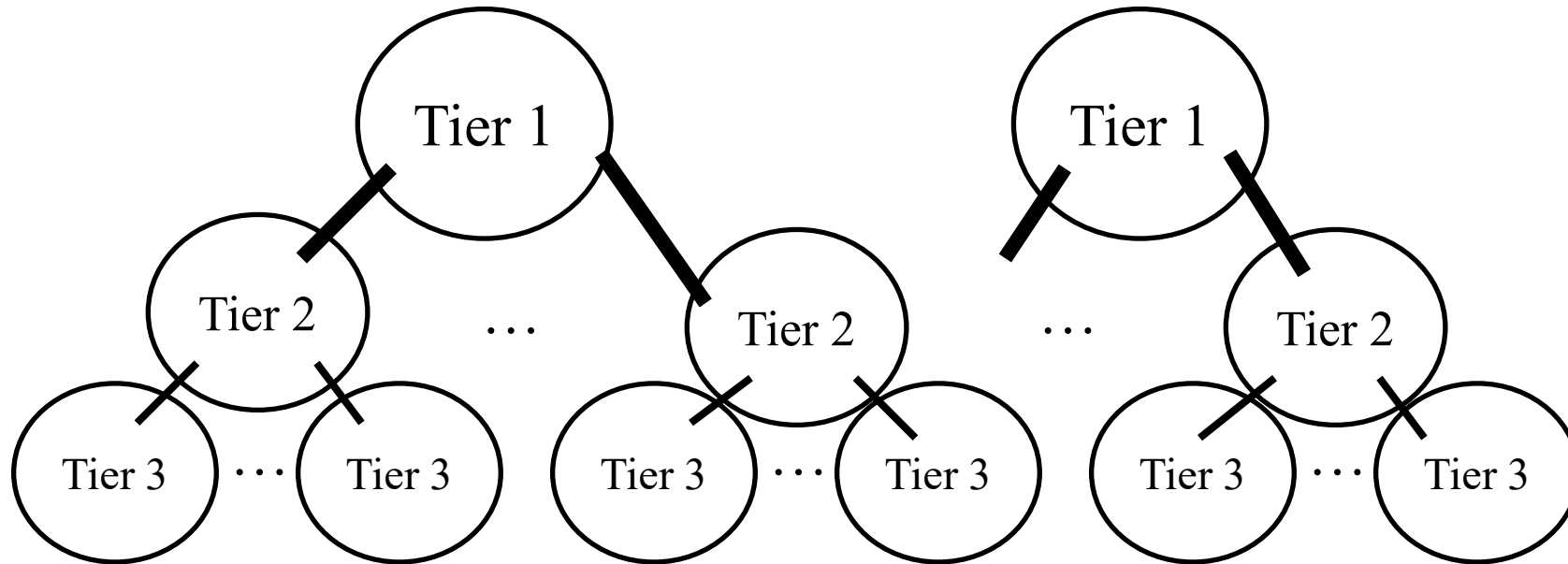

- ❑ **Tier 1:** Global or National, e.g., AT&T, Verizon, ...
- ❑ Tier 2: Regional
- ❑ Tier 3: Local

## Student Questions

- ❑ At what level/tier are tier 1 ISPs usually connected to each other?  
*There are no higher Tier ISPs. A Tier 1 network might be connected to another Tier 1 network through a third Tier 1 network.*
- ❑ Would you elaborate on practical differences between coaxial vs. twisted pair (for example, relative transmission rates) and on practical differences between wireless vs. microwave?
- ❑ Is all wireless microwave?  
*No. Please wait till Module 7.*
- ❑ Is the main upside to unguided transmission media the ability to have the end system be more mobile?  
*Sometimes wireless is used between towers to reduce cabling cost.*
- ❑ When you refer to just "fiber", are you referencing optic fiber? *Yes*
- ❑ Who decides which ISP belongs to what tier?  
*Higher tiers provide services to lower tiers.*
- ❑ Could Tier 2 or 3 use the infrastructure of Tier 1's network? *Yes.*
- ❑ Do Tier 1 ISPs always cover regions that Tier 2/3 ISPs cover? *Not necessary.*

# Types of ISPs

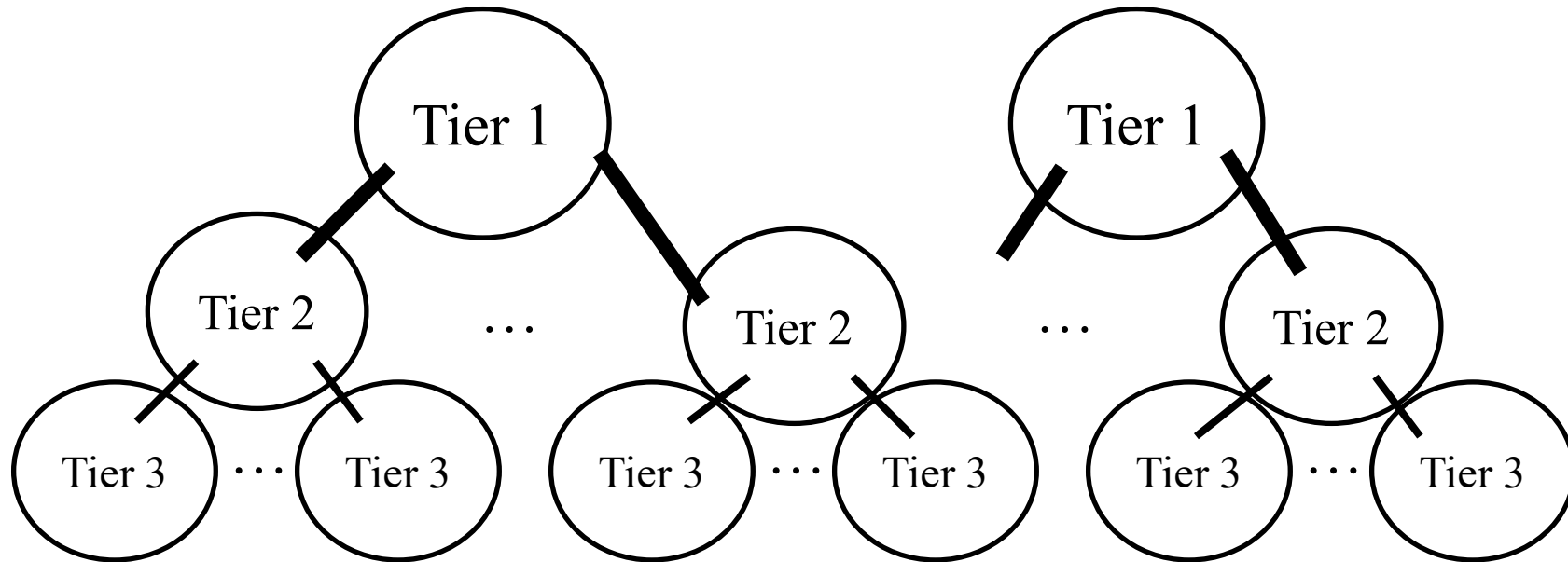

- ❑ **Tier 1**: Global or National, e.g., AT&T, Verizon, ...
- ❑ Tier 2: Regional
- ❑ Tier 3: Local

## Student Questions

- ❑ Is the connection between Tier 1 and Tier 2 or the connection between Tier 2 and Tier 3 core networks? *Both*
- ❑ What is the relationship between Tier and an ISP Network? *Tier is a class of ISPs.*

---

❑ What is the relationship between ISP in different tiers? Do they provide the same service, or do they divide their work?

*Their distances, speeds, and customers are different*

❑ Does the regional ISP use tier 1 ISP to connect with other regional ISPs? *Yes.*

❑ Do the different tiers of networks share the same speed?

*Tier 1 has more traffic than Tier 2.  
Tier 1 has a higher speed than Tier 2.*

# Types of ISPs

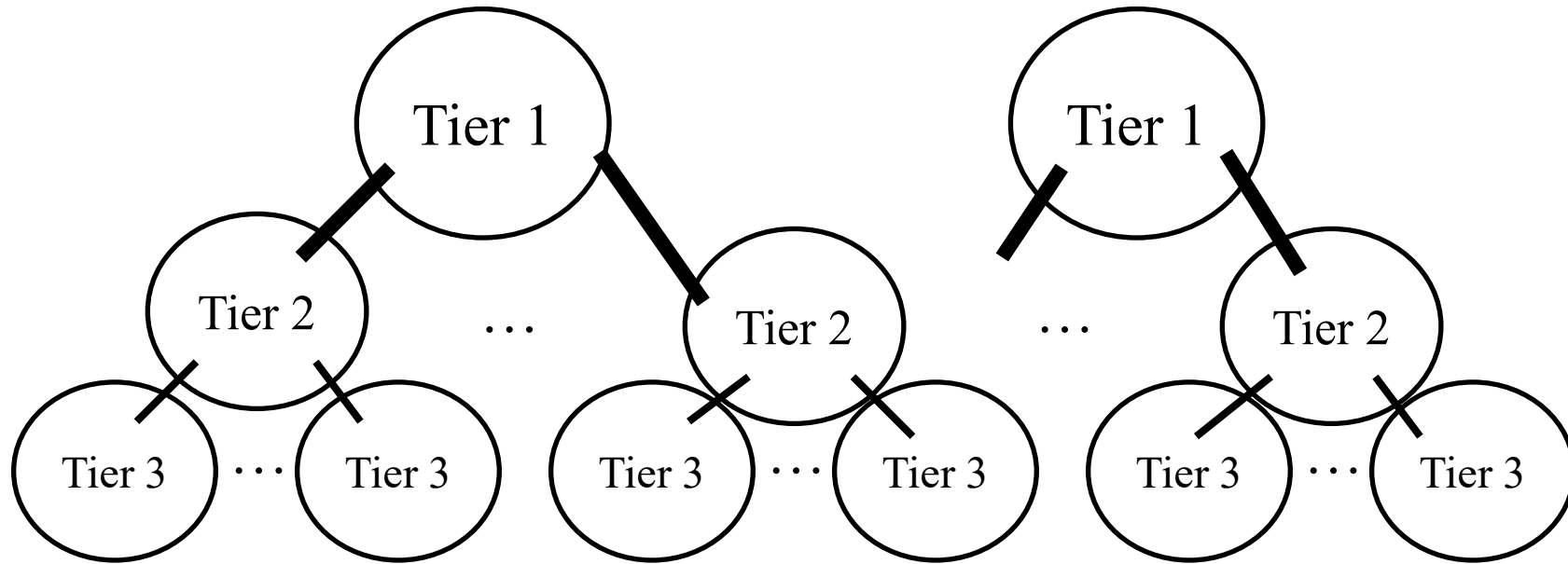

- ❑ **Tier 1:** Global or National, e.g., AT&T, Verizon, ...
- ❑ **Tier 2:** Regional
- ❑ **Tier 3:** Local

## Student Questions

- ❑ Are there connections between networks of the same tier, or do they always communicate via a higher-tier network?

*No specific requirements. These are business arrangements.*

# Transmission Media

## □ Guided:

- Twisted Pair
- Coaxial cable
- Optical fiber

## □ Unguided:

- Microwave
- Satellite
- Wireless

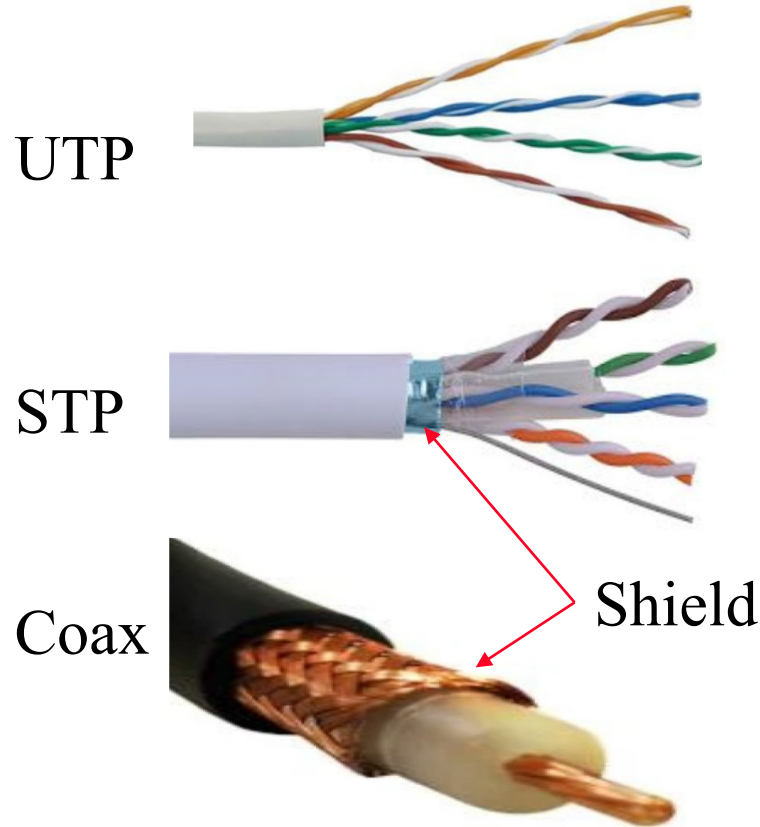

## Student Questions

- It was mentioned in the lecture that a Coaxial cable is an example of an STP (Shielded Twisted Pair). Googling the difference seems to indicate that "Twisted Pair Cables" are distinct from "Coaxial Cables." Can you clarify the relationship between Twisted Pair vs. Coaxial?  
*The coaxial cable is shielded but not twisted because it has only one wire. STP has many pairs, and each pair is twisted. A metallic shield protects all pairs.*
- Is microwave how all wireless connections are made? *Most.*
- Is there such a thing as an unguided wired transmission medium? *Antenna*
- What is a coaxial cable? *Cable from the cable company*
- Can a communication bus be either guided or unguided? *Busses are usually guided.*
- Are there any strong advantages of using guided over unguided and vice versa?  
*Yes. Security.*

# Transmission Media

## □ Guided:

- Twisted Pair
- Coaxial cable
- Optical fiber

## □ Unguided:

- Microwave
- Satellite
- Wireless

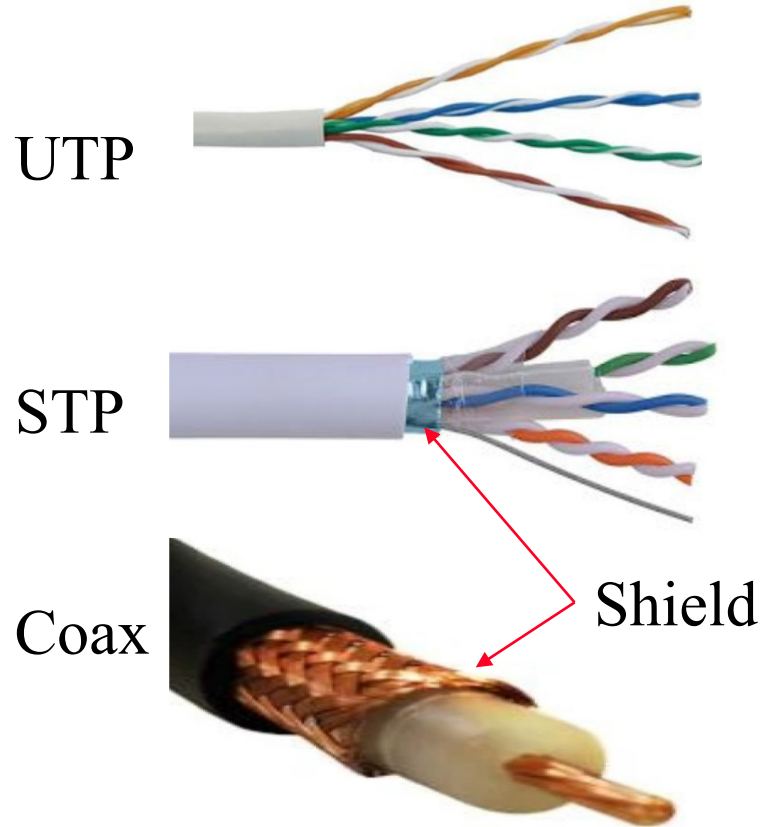

## Student Questions

- Why can't we know where signals go in unguided media? Does it have to do with frequency? *We know. We can sense it.*
- Why are coax cables single-wire? *They are thick. If you use multiple wires, you have to twist them, which we call STP.*
- How is noise dealt with for wireless transmission media?  
*To be covered in Chapter 7.*
- What exactly is Coax? How is it different from STP?  
*Coax = Single thick wire usually used by video providers*  
*STP = Needs at least two wires to twist*
- If the microwave is undirected, why do trading companies send data between New York and Chicago via disc relays?  
*Microwave=wireless*  
*Companies use whatever they can.*  
*Microsecond delays on trades can make big difference.*

# Twisted Pair (TP)

- Separately insulated
- Twisted together
- Often "bundled" into cables
- Usually installed in building during construction



(a) Twisted pair

- ❑ Twists decrease the cross-talk
- ❑ Neighboring pairs have different twist length
- ❑ Most of telephone and network wiring in homes and offices is TP.

## Student Questions

- ❑ What is the mechanism behind twisted pairs can reducing cross-talk? Why do neighboring pairs need to have different twist lengths? Did there exist a limit speed for twisted pairs? *Part of Electrical Engineering Communications course.*
- ❑ Why do twisted pairs help to reduce interference?

*Canceling electromagnetic interference.*

- ❑ Would two untwisted wires running parallel interfere with each other? Also, would wire pairs twisted at the same twist length interfere with each other?

*Yes. Yes. More similarity=> More interference.*

- ❑ In a twisted pair, is one the main channel and the other serves as shielding, or are both interpreted at the destination?

*Both.*

- ❑ How does TP lower the interference or cross-talk?

*Interference cancels out*

# Twisted Pair (TP)

- Separately insulated
- Twisted together
- Often "bundled" into cables
- Usually installed in building during construction



(a) Twisted pair

- ❑ Twists decrease the cross-talk
- ❑ Neighboring pairs have different twist length
- ❑ Most of telephone and network wiring in homes and offices is TP.

## Student Questions

- ❑ How do the differing twist lengths play into things?  
*More twists are better.*
- ❑ What are the negatives to having a maximum twist on wires? If twisting helps to mitigate any outside interference, why not twist as much as possible?  
*The wire may break or be difficult to bend/handle.*
- ❑ Are the multiple wires in phone or laptop charging and data cables considered TP?  
*Phone wire may or may not be twisted. Network wires are all twisted. Charging cables without data capability are not twisted.*

# Twisted Pair (TP)

- Separately insulated
- Twisted together
- Often "bundled" into cables
- Usually installed in building during construction



(a) Twisted pair

- ❑ Twists decrease the cross-talk
- ❑ Neighboring pairs have different twist length
- ❑ Most of telephone and network wiring in homes and offices is TP.

## Student Questions

- ❑ Why would we need more or fewer twisted pairs?

*More pairs  $\Rightarrow$  More data can be sent  $\Rightarrow$  Higher speed.*

- ❑ Why are there four pairs of twisted pairs in a cable? What not 3 2 1?

*10 Mbps Ethernet had 2 pairs. 100 Mbps and up requires 4 pairs.*



# Shielded and Unshielded TP

## ❑ Shielded Twisted Pair (STP)

- Metal braid or sheathing that reduces :
- More expensive
- Harder to handle (thick, heavy)
- Used in token rings

## ❑ Unshielded Twisted Pair (UTP)

- Ordinary telephone wire
- Cheap, Flexible
  - ⇒ Easiest to install
- No shielding
  - ⇒ Suffers from external interference
- Used in Telephone and Ethernet

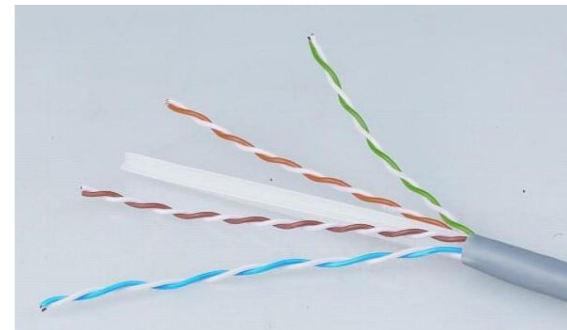

## Student Questions

- ❑ How specifically is infrared light used to input in optical cables?

*Lasers are used to inject light into a hair-thin optical fiber.*

- ❑ What are token rings?

*Competed with but obsoleted by Ethernet.*

- ❑ Are UTPs links? If so, does UTP use FDM or TDM? *You can use either one.*

- ❑ Is twisted length the standard to differentiate those categories?

*One of many parameters.*

- ❑ How to distinguish between a telephone wire and an Ethernet wire?

*Telephone=2 or 4 wires*

*Ethernet=8 wires*

- ❑ Since Ethernet uses UTP, and telephones use UTP too, can we use the telephone wire as an Ethernet cable?

*No. You can use an Ethernet cable as a phone wire but not the other way around. Ethernet requires higher performance.*

# Shielded and Unshielded TP

## ❑ Shielded Twisted Pair (STP)

- Metal braid or sheathing that reduces :
- More expensive
- Harder to handle (thick, heavy)
- Used in token rings

## ❑ Unshielded Twisted Pair (UTP)

- Ordinary telephone wire
- Cheap, Flexible
  - ⇒ Easiest to install
- No shielding
  - ⇒ Suffers from external interference
- Used in Telephone and Ethernet

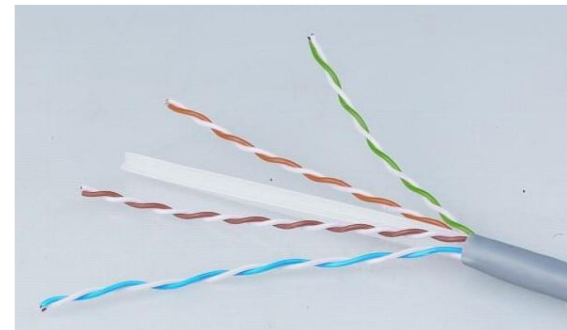

## Student Questions

❑ Are there Cat 1 and Cat 2? *No longer.*

❑ How does the metal braid or sheathing of STP reduce interference?

*Braid catches the interfering signal.*

❖ Are USB cables twisted pairs?  
*Of the four wires (two pairs), one is data pair, and it is twisted.*

# UTP Categories

## □ Cat 3

- Up to 16MHz
- Voice grade found in most offices
- Twist length of 7.5 cm to 10 cm

## □ Cat 4

- Up to 20 MHz. Not used much in practice.

## □ Cat 5

- Up to 100MHz
- Used in 10 Mbps and 100 Mbps Ethernet
- Twist length 0.6 cm to 0.85 cm

- Cat 5E (Enhanced to 100 MHz),  
Cat 6 (250 MHz), Cat 6A (500 MHz),  
Cat 7 (700 MHz), CAT 7A (1000 MHz)  
Cat 8 (2000 MHz), ...

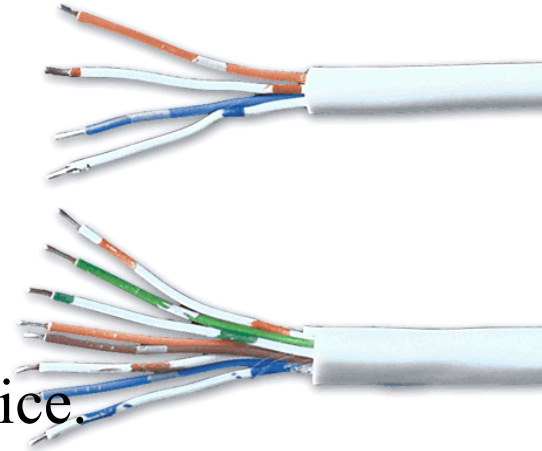

## Student Questions

- What is the number behind the Cat (Category) related to the frequency it can hold? *Class or quality.*
- When you say broadcast if we transmit too much data over the wire, do you mean that it will be leaked out and can be picked up by a 3rd party?

*Broadcast=Everyone can hear it.*

- Why does a shorter twisted length correspond to a higher transmission rate?  
*Taught in ECE Communications courses.*
- Is our network speed bound by the slowest transmission media? If so, how can we detect the bottlenecks on our end?

*There are many ways to find the bottleneck.*

- Do different amounts of Hz of different UTP categories mean their ability to send those kinds of signals? Like from 10 MHz up to 100 MHz? And why more MHz means better UTP.

*More MHz = More bits/second*

Ref: [https://en.wikipedia.org/wiki/ISO/IEC\\_11801](https://en.wikipedia.org/wiki/ISO/IEC_11801)

Washington University in St. Louis

<http://www.cse.wustl.edu/~jain/cse473-23/>

©2023 Raj Jain

# UTP Categories

## ❑ Cat 3

- Up to 16MHz
- Voice grade found in most offices
- Twist length of 7.5 cm to 10 cm

## ❑ Cat 4

- Up to 20 MHz. Not used much in practice.

## ❑ Cat 5

- Up to 100MHz
- Used in 10 Mbps and 100 Mbps Ethernet
- Twist length 0.6 cm to 0.85 cm

- ❑ Cat 5E (Enhanced to 100 MHz),  
Cat 6 (250 MHz), Cat 6A (500 MHz),  
Cat 7 (700 MHz), CAT 7A (1000 MHz)  
Cat 8 (2000 MHz), ...

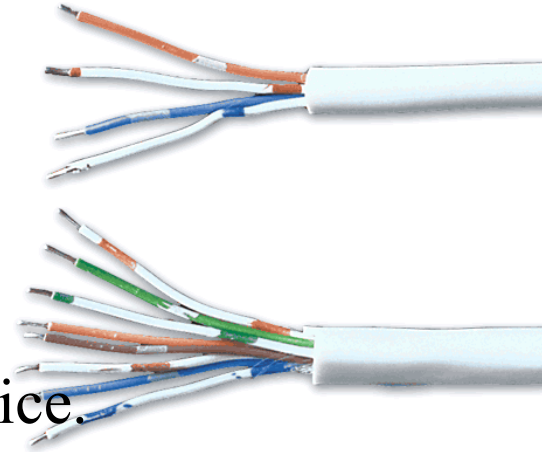

## Student Questions

- ❑ Does UTP with a larger category number have more TP pairs inside it?

*No. Thicker wires.*

- ❑ What exactly does the frequency of a wire indicate?

*It cuts off the signal of higher frequency.*

- ❑ Does the color of the Ethernet cable correspond to a specific category?

*No.*

- ❑ Is there a mathematical scale to the categories assigned to UTP cables, or is it more arbitrary?

*Yes. See MHz.*

Ref: [https://en.wikipedia.org/wiki/ISO/IEC\\_11801](https://en.wikipedia.org/wiki/ISO/IEC_11801)

Washington University in St. Louis

<http://www.cse.wustl.edu/~jain/cse473-23/>

©2023 Raj Jain

# UTP Categories

## ❑ Cat 3

- Up to 16MHz
- Voice grade found in most offices
- Twist length of 7.5 cm to 10 cm

## ❑ Cat 4

- Up to 20 MHz. Not used much in practice.

## ❑ Cat 5

- Up to 100MHz
- Used in 10 Mbps and 100 Mbps Ethernet
- Twist length 0.6 cm to 0.85 cm

- ❑ Cat 5E (Enhanced to 100 MHz),  
Cat 6 (250 MHz), Cat 6A (500 MHz),  
Cat 7 (700 MHz), CAT 7A (1000 MHz)  
Cat 8 (2000 MHz), ...

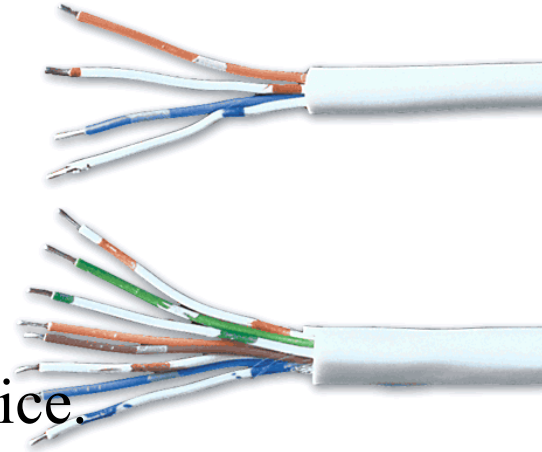

## Student Questions

- ❑ Why is there a gap between the release of each Cat version? For example, why would Cat 8 be used much later than Cat 3 if the only difference is the number of wire pairs?

*Higher Cats are more expensive, and there is no market if there is no need.*

Ref: [https://en.wikipedia.org/wiki/ISO/IEC\\_11801](https://en.wikipedia.org/wiki/ISO/IEC_11801)

Washington University in St. Louis

<http://www.cse.wustl.edu/~jain/cse473-23/>

©2023 Raj Jain

# Optical Fiber

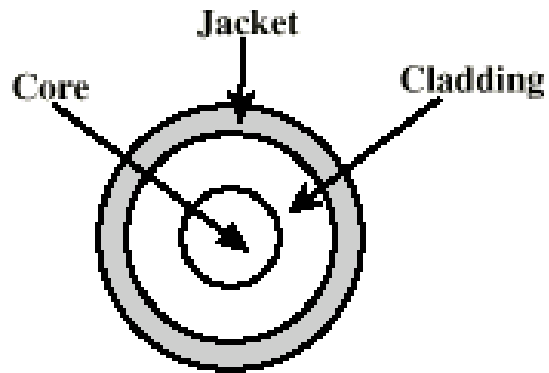

- Glass or plastic core
- Laser or light emitting diode
- Specially designed jacket
- Small size and weight

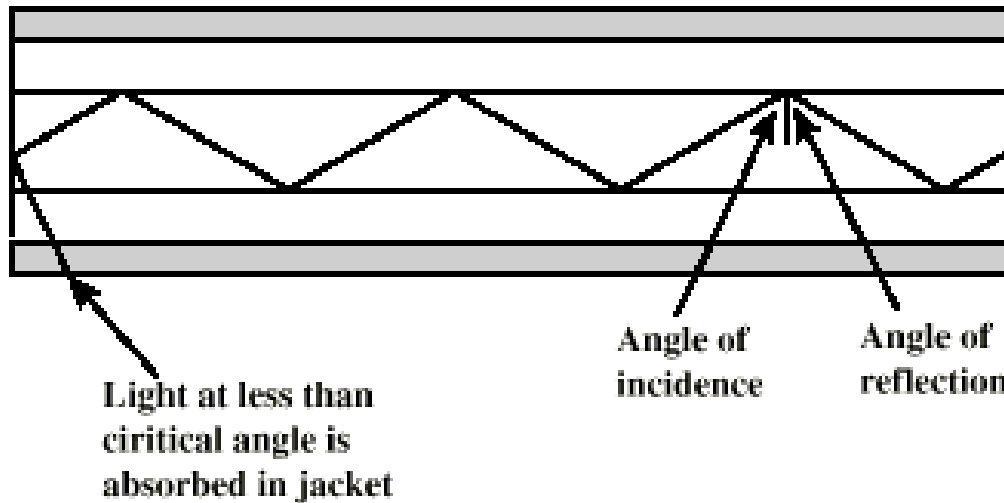

- ❑ A cylindrical mirror is formed by the cladding.
- ❑ The light wave propagates by continuous reflection in the fiber
- ❑ Not affected by external interference  $\Rightarrow$  low bit error rate
- ❑ Fiber is used in all long-haul or high-speed communication
- ❑ Infrared light is used in communication

## Student Questions

- ❑ Is infrared considered to be a subset of microwaves?  
*These are different frequencies. See Slide 18.*
- ❑ How much do we need to know about the spectrum? (like what range is radio)  
*Yes.*
- ❑ Is it possible to use ultraviolet light or visible light for optical communication, as both of them have a shorter wavelength and thus seem to have a higher possible transmission rate?

*Yes. The properties of the signal are different, and so cost and applications are different.*

- ❑ How is it possible for light at less than critical angles to be absorbed in a jacket?  
*Light can become heat.*
- ❑ How is the optical fiber cable able to send light signals even when the cable is bent? Wouldn't the bending of the cable distort the path of the light?

*No bends are like a mile-wide turn for nano-nano-meter waves.*

# Optical Fiber

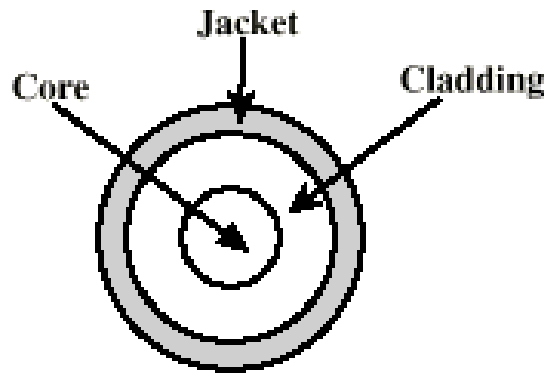

- Glass or plastic core
- Laser or light emitting diode
- Specially designed jacket
- Small size and weight

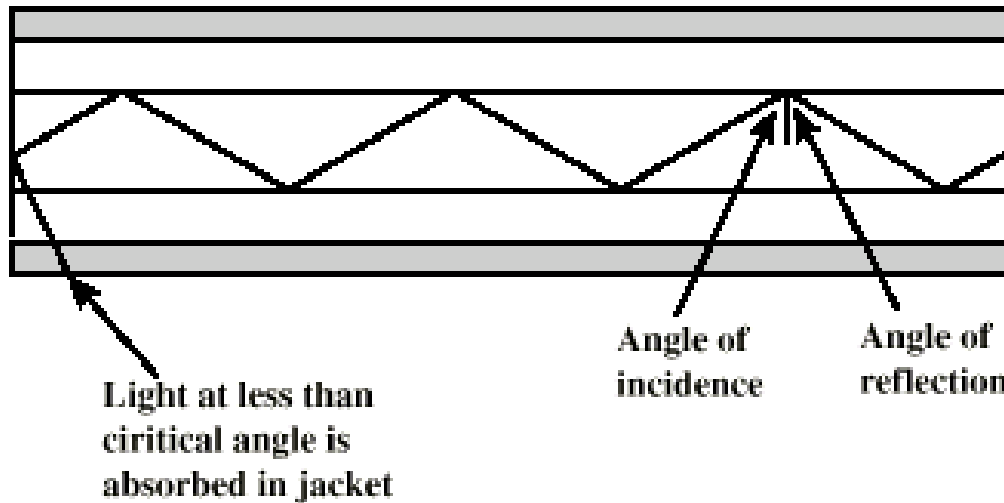

- ❑ A cylindrical mirror is formed by the cladding.
- ❑ The light wave propagates by continuous reflection in the fiber
- ❑ Not affected by external interference  $\Rightarrow$  low bit error rate
- ❑ Fiber is used in all long-haul or high-speed communication
- ❑ Infrared light is used in communication

## Student Questions

- ❑ Is cost the only benefit of copper over optical?

*Also, tools to connect copper are simpler.*

- ❑ Must the laser travel through optical fiber be polarized?
- ❑ What are some advantages of optical fiber over twisted pairs?

*No electrical interference.*

- ❑ As mentioned, there are 15 lights of different wavelengths. Is this frequency division multiplexing?

*Yes, if you transmit all of them simultaneously. But we don't.*

# Optical Fiber

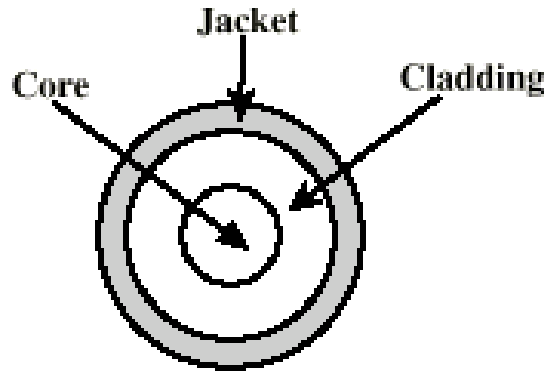

- Glass or plastic core
- Laser or light emitting diode
- Specially designed jacket
- Small size and weight

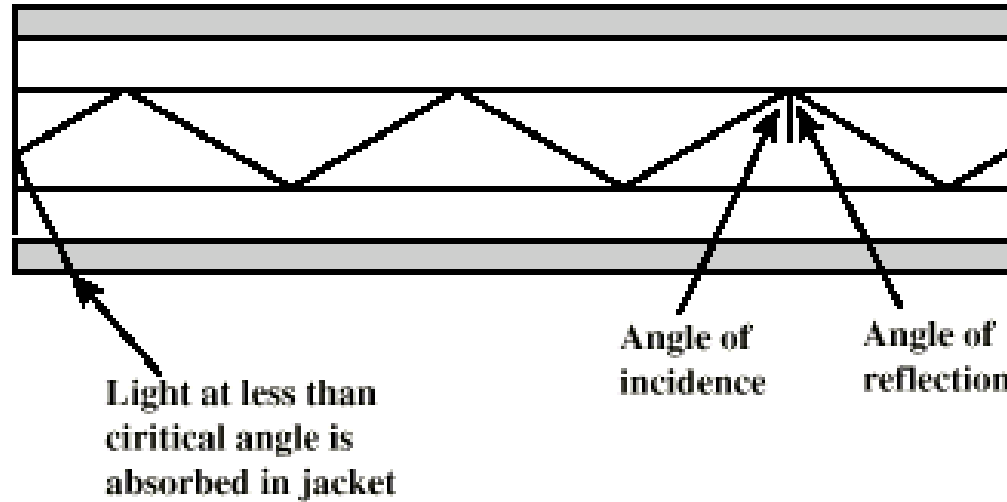

- ❑ A cylindrical mirror is formed by the cladding.
- ❑ The light wave propagates by continuous reflection in the fiber
- ❑ Not affected by external interference  $\Rightarrow$  low bit error rate
- ❑ Fiber is used in all long-haul or high-speed communication
- ❑ Infrared light is used in communication

## Student Questions

- ❖ Can you explain why optical fiber has better bandwidth but copper is faster? Perhaps explaining the data transfer in a visual way will help.

*Light speed varies with the index of refraction. The index of refraction of the fiber is 1.5 and so the light travels 1.5 times slower in fiber than that in open space, i.e., 200 m/us. Electrical propagation is more complicated. The speed is 250 m/us. Bandwidth depends on the interference. There is little interference in light propagation inside fiber.*



# Optical Communication...History

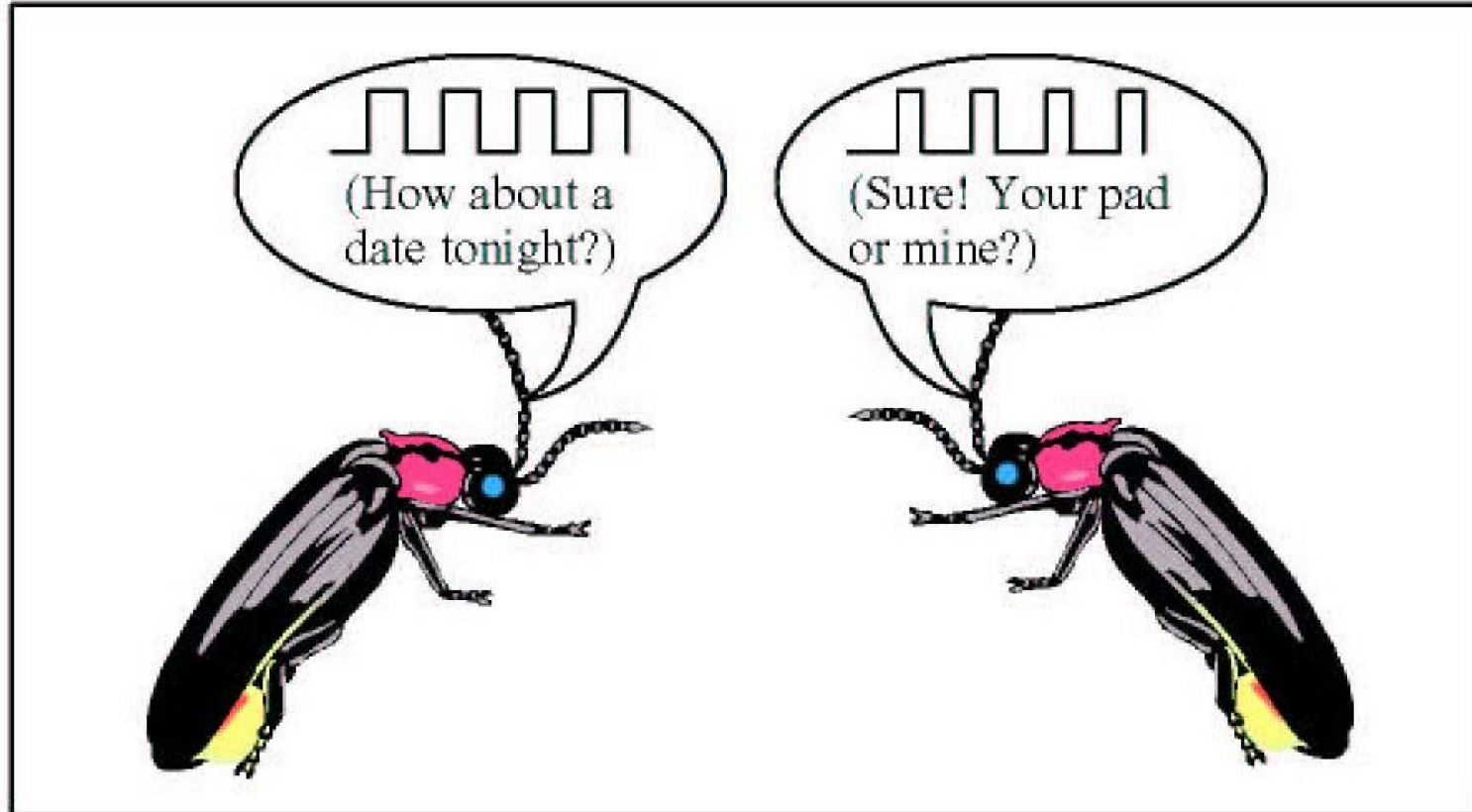

Fireflies use pulse-width modulation.

## Student Questions

- ❑ Do we get the idea of optical communication from fireflies? *No.*
- ❑ Is this what happens in the optical fiber? *Yes.*
- ❑ Why do we transmit a signal? What other ways can we do the same thing today?

*Signal=Communication*

*Oral, electrical, visual, ...*

---

# Electromagnetic Spectrum

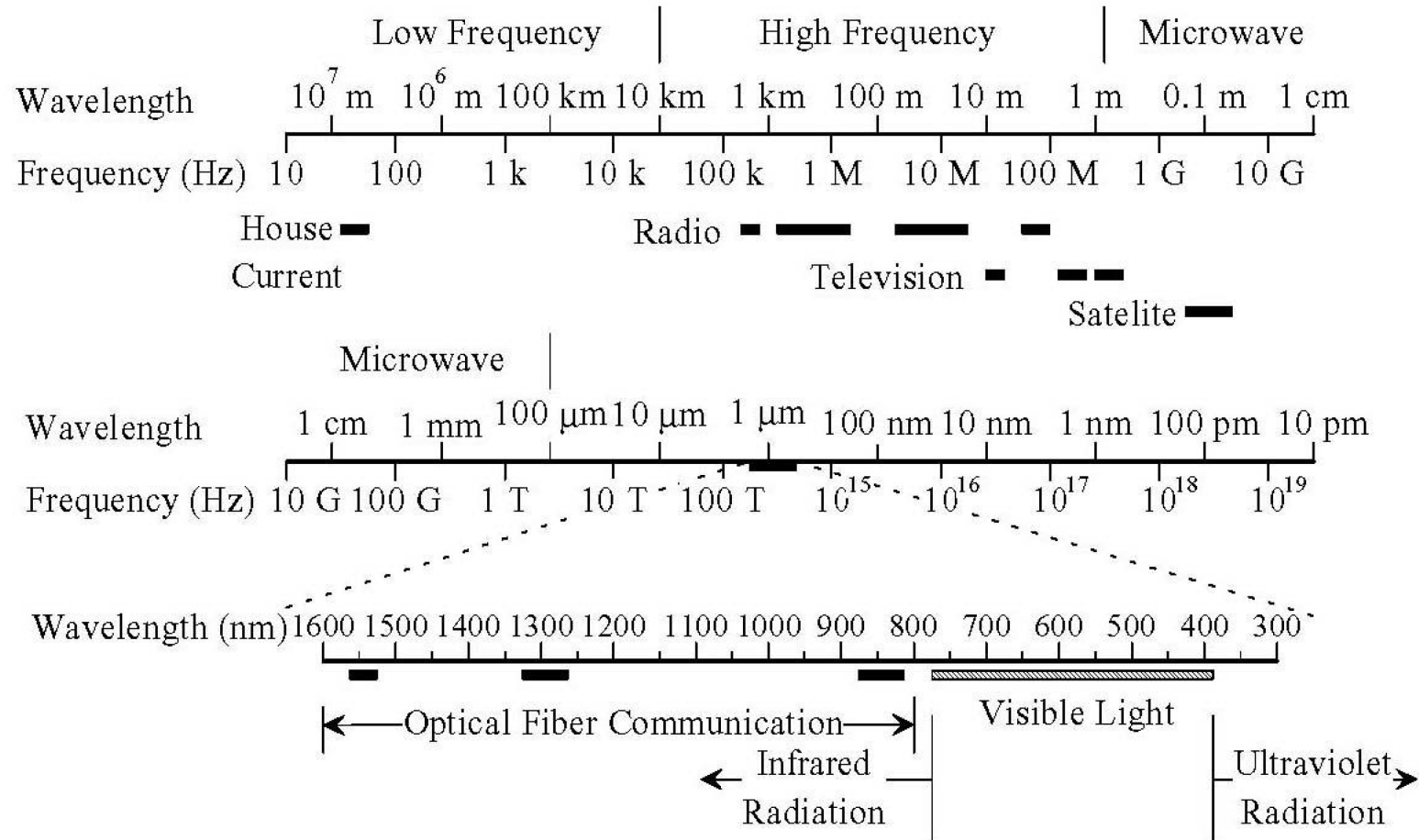

- Infrared light is used for optical communication.

## Student Questions

- Why can't we use higher or lower frequencies for optical fiber communication?  
*Lower frequencies are all used up.*
- Why do we use infrared light for optical communication and not something else (e.g., ultraviolet)?  
*Part of the advanced networking course.*
- How do we interpret the wavelength or frequency as data we can actually understand?  
*Coding. Like Morse code.*
- Would there be an advantage to using wavelengths of light with higher frequencies in an optical connection?  
*Both advantages and disadvantages.*
- So technically, I can receive a TV signal by radio which can receive a higher frequency, right?  
*Yes. TV is a radio too.*
- Does this mean that we can potentially communicate with the wave the same as a microwave oven?  
*We do it every day. Wi-Fi is a microwave.*

# Electromagnetic Spectrum

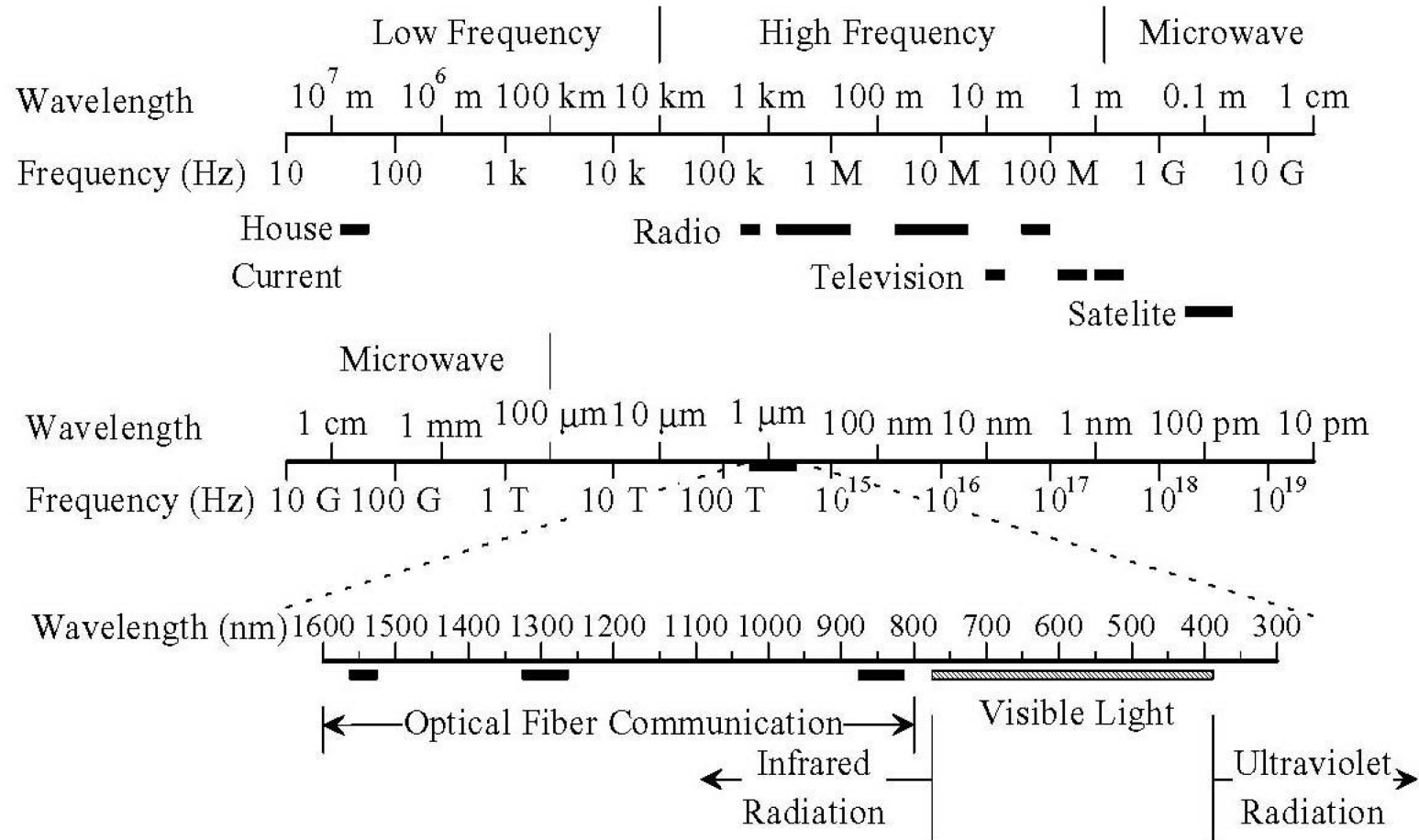

- Infrared light is used for optical communication.

## Student Questions

- What should we be able to identify on the electromagnetic spectrum?
- Basic relationships between various components. Not the fine print of the numbers.*
- What is the value of the Electromagnetic Spectrum figure? Is it just to show the wavelengths of Optical Fiber Communication?
- To understand that sound, electricity, radio, microwave, and light, x-rays are similar.*
- What are the black bars in the figure?
- Each black bar has an associated application.*
- Do 4G and 5G Wi-Fi mean their frequency?
- No. G=Generation*
- Does the 5G network use higher frequency waves than 4G?
- No.*

# Electromagnetic Spectrum

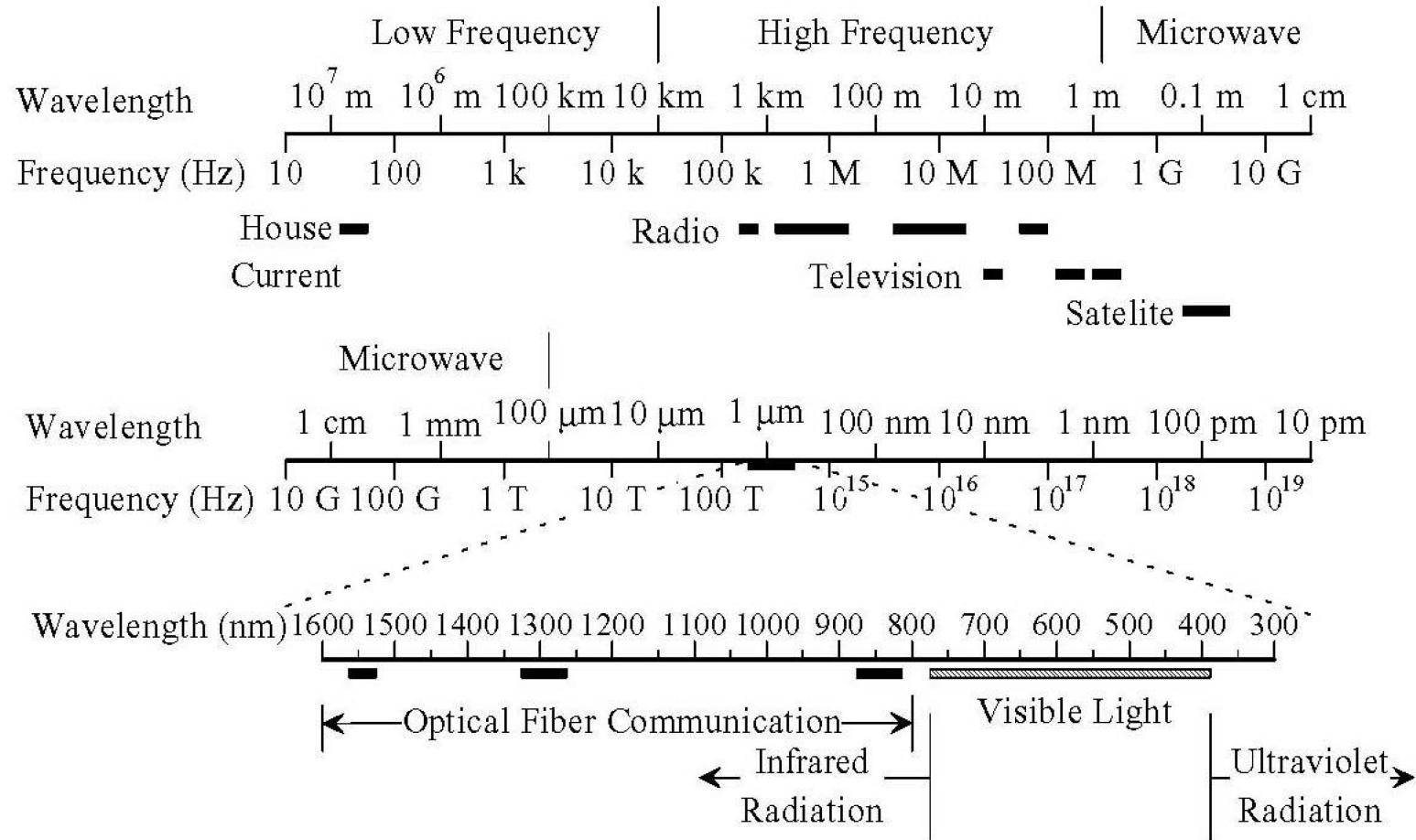

- ❑ Infrared light is used for optical communication.

## Student Questions

- ❑ Does optical communication use a much higher frequency than copper or wireless communication? How will this affect the transmission speed?  
*All electromagnetic signals travel at the same speed.*
- ❑ Why is infrared used for optical and not something with a smaller or larger frequency?  
*Lower frequencies are cheaper.*
- ❑ Are/will the EM waves get to be unsafe for our bodies? How are engineers facing the issue?  
*Debatable issue.*
- ❖ What exactly is bandwidth?  
*Width of the frequency band*

# Homework 1A: Networking Media

- [6 points] Which networking media will you use for the following applications and why?
  1. Very large file transfer at home
  2. High-speed multiple-channel video transmission at an office
  3. News reading while traveling in a car

Note: Do not write the name of the protocol.  
Write the name of the media and justify it.

## Student Questions

- Do we need to do this homework, or is this just for some previous semester? *While the video is from a previous live class. The slides have been updated for this semester. So, yes, you need to do the homework and submit it on the Monday following the class discussion.*
  - Are homework 1A and 1B both due next Monday? (Jan. 24th) *Yes.*
  - By plain text files, do you mean txt files? *Yes.*
  - So we need a paragraph for each question? *Yes.*
- 
- What do you mean by Networking media?  
*UTP, STP, coax, wireless, fiber, ...*

# Network Edge: Enterprise Networks

1. Ethernet
2. Wi-Fi

## Student Questions

- ❑ What is a Network Edge? *Opposite of Network core.*
- 
- ❑ What are the differences between Ethernet and twisted pair, Wi-Fi and microwaves?  
*Will be covered shortly*

# Ethernet



- ❑ Uses UTP (Unshielded Twisted Pair)
- ❑ 10 Mbps, 100 Mbps, 1 Gbps, 10 Gbps
- ❑ Originally bus, now point-to-point (Star) topology

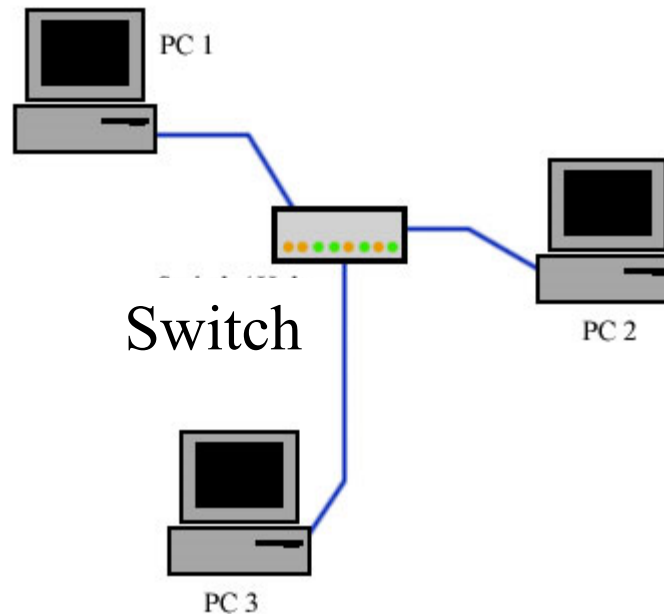
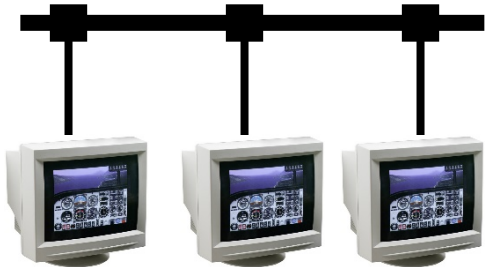

## Student Questions

- ❑ Was it the bus or star topology that was more robust against single connection faults?  
*The bus is susceptible to single cable faults.*
- ❑ Was it difficult to transit from the bus to the star topology? *No. Both existed at the same time.*
- ❑ If one client fails in a bus, is the whole chain broken? *Maybe. Maybe not.*

- 
- ❑ Do internet protocols specify which media they will use for communication?

*No, except for media access protocols.*

- ❖ Do we need to remember the transmission rate of different network mediums (ex., Ethernet, UDP...)

*Not yet.*

# Wi-Fi

- ❑ IEEE 802.11  
(Institution of Electrical and Electronic Engineers)
- ❑ Uses 2.4 GHz and 5.8 GHz



## Student Questions

- ❑ Wi-Fi usually has a router and modem, is a modem a host and a router an intermediate system?

*Modem, too, is an intermediate system.*

- ❑ Can we not follow the IEEE guidelines?

*We do.*

- ❑ Can you elaborate on how 2.4 GHz "ran out" and why we need to expand to 5.8 GHz? *Too many nodes broadcasting on the same frequency overloaded 2.4 GHz.*

- ❑ Are 2.4 and 5.8 also called 2G and 5G? If the frequency is fixed, why in real life is the speed still changing or fluctuating?

*No. 2G and 5G are different generations.*

*Covered in Wireless chapter.*

- ❑ Do we use 2.4 GHz and 5.8 GHz at the same time? E.g., when we close the router, we use 5.8 GHz, further away we use 2.4 GHz.

*We started with lower/cheaper frequencies.*



# Access Networks

1. DSL (Digital Subscriber Line)
2. Cable
3. Fiber-To-The-Home
4. Wi-Fi
5. LTE (Long Term Evolution)

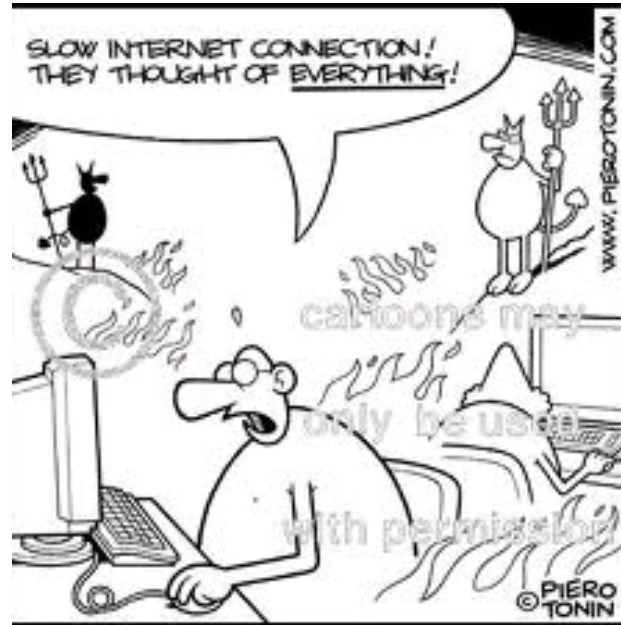

## Student Questions

- How is LTE different from 4G? *This is discussed in Module 7. LTE is 3.9G or pre-4G.*
  - What is LTE/ what does Long Term Evolution mean? *Please wait till Module 7.*
  - Does Fiber to the Home mean Optical fiber? *Yes.*
  - What exactly is Fiber-To-The-Home? *AT&T Fiber and Verizon Fiber are FTTH services.*
  - What exactly does "Long Term Evolution" mean? *"In the distant future."*
  - Can you explain how dial-up Internet works? How, if at all, does it relate to DSL? *Too detailed for now.*
  - Was fiber to the homeless common only because of cost, or were there other factors as well? *Cost.*
- 
- Is 4G LTE inferior to 5G? *Yes.*

# DSL

- ❑ **Digital Subscriber Line (DSL)**
- ❑ Can transmit very high data rates on phone wire using special equipment at the phone company, allowing higher frequency signals

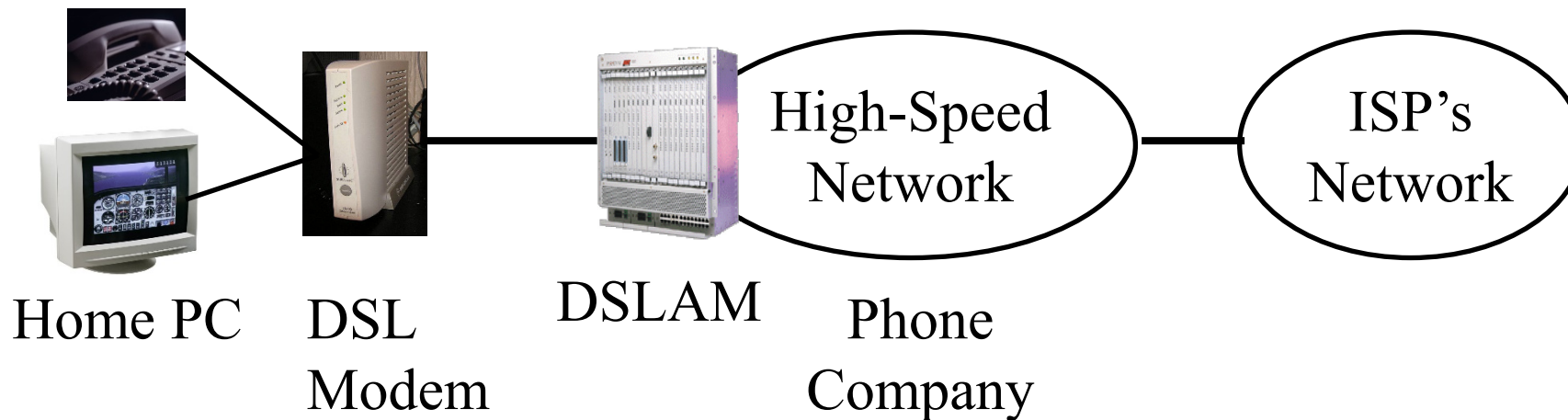

- ❑ DSL Access Multiplexer (**DSLAM**)
- ❑ 100 kbps - 100 Mbps

## Student Questions

- ❑ Where do we turn in our in-class assignment?  
*Unless indicated otherwise, all homework should be submitted on Canvas.*
  - ❑ What kind of wire is a phone wire?  
*The wire is used to connect to your home phone.*
  - ❑ Is DSL the same thing as Dial-Up?  
*DSL is a data service using the same wires that were used for phones.*
  - ❑ Is DSL similar to a phone line?
  - ❑ What is a multiplexer? *Combines many circuits*
- 
- ❑ Is the connection between DSL Modem and DSLAM analog?  
*No. It is digital.*
  - ❑ Is this method in use today?  
*Yes.*
  - ❑ Are DSL Modems and DSLAM intermediate systems?  
*Yes.*

# DSL

- ❑ **Digital Subscriber Line (DSL)**
- ❑ Can transmit very high data rates on phone wire using special equipment at the phone company, allowing higher frequency signals

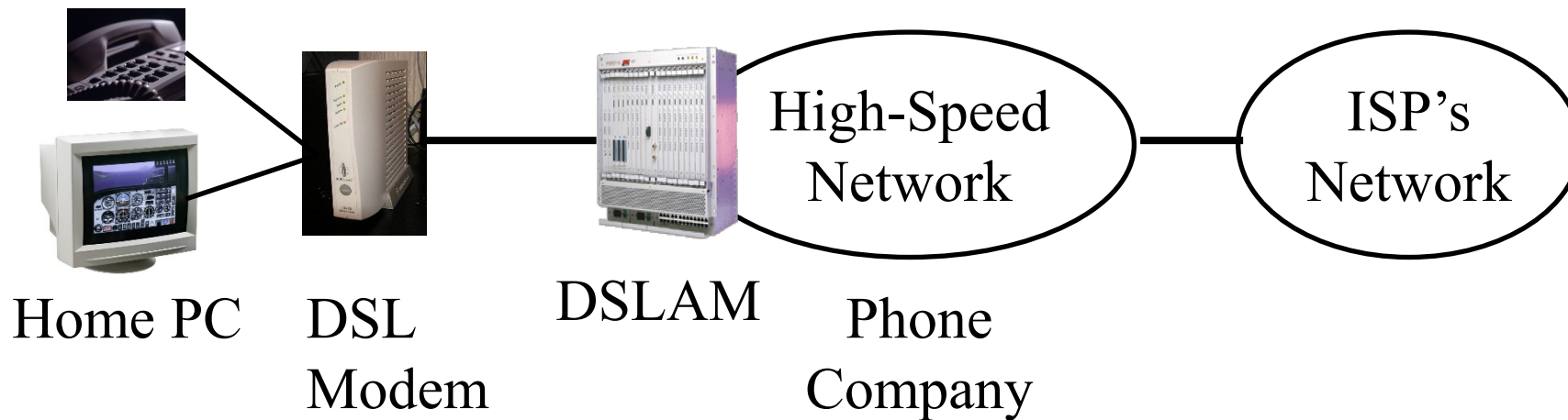

- ❑ DSL Access Multiplexer (**DSLAM**)
- ❑ 100 kbps - 100 Mbps

## Student Questions

- ❑ Why is DSL only used for phone companies?

*They own subscriber lines.*

- ❖ Are DSL the same as dial-up Internet?

*No. Dial-up requires a modem for digital to analog conversion. DSL takes in digital directly.*



# Cable

- ❑ Cable companies have a very-high-speed medium (for video transmission)
- ❑ Phone wire = 4kHz for voice  
Video Cable = 500 MHz for video  
One TV Channel = 6 MHz
- ❑ 100 Mbps down/10 Mbps up
- ❑ Fiber in the main line + Coax in tributaries  
⇒ Hybrid Fiber Coax (HFC)



Cable Modem

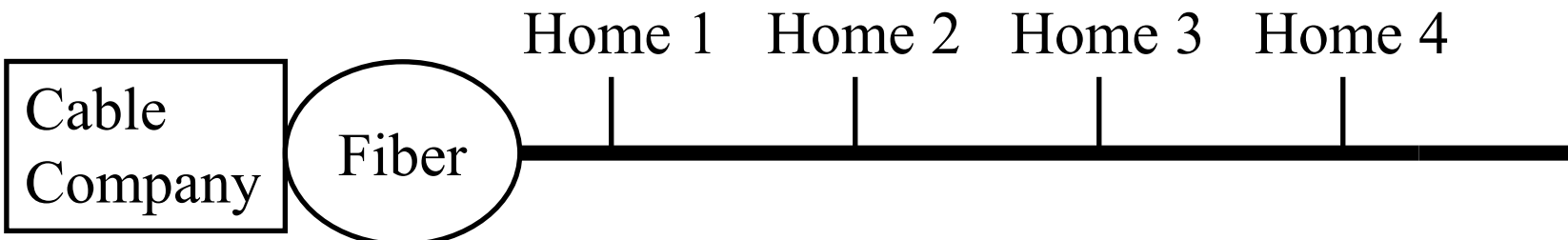

## Student Questions

- ❑ Why is the upload speed always slower than the download speed? *Not always. On point-to-point fiber, upload = download.*
- ❑ Is it the only difference in structure between DSL and cable that DSL uses UTP while cable uses coaxial wire?  
*No, there are many other differences. Not just media but also protocols.*
- ❑ Will using a longer Ethernet cable slow down the connection speed?  
*It depends upon the type of Ethernet. Older Ethernet -yes. Current Ethernet -no.*
- ❑ What is the benefit of HFC?  
*Combines copper and fiber to reduce cost*

- 
- ❑ What's the relationship between front haul/backhaul and download/upload?

*Fronthaul = Access*

*Backhaul = Core*

*Download = Towards the customer*

*Upload = Towards the provider*

# Fiber-To-The-Home (FTTH)

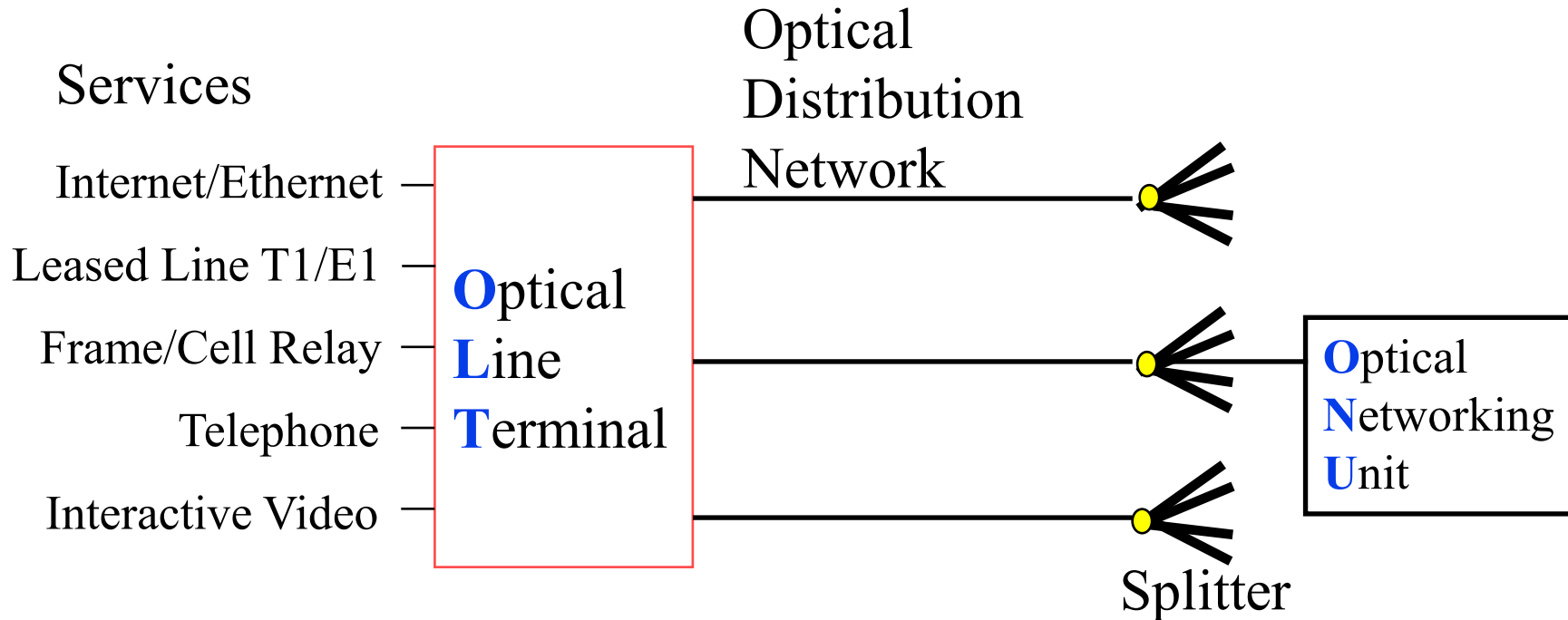

- ❑ 1+ Gbps per home. Multiple services.
- ❑ No electronic components in the distribution system  
⇒ Passive ⇒ Reliable
- ❑ Passive Optical Network (PON)

## Student Questions

- ❑ What is the difference between analog and digitalized DSL?

*Analog signal* 

*Digital signal* 

- ❑ How frequently is FTTH used in the US compared to cable?

*AT&T Fiber just came to St. Louis.*

- ❑ Is FTTH more reliable than cable?

*Not necessarily.*

- ❑ Do DSL and cable also use a passive splitter as FTTH does? If not, then how do they distribute the packets?

*DSL has switches and routers to distribute packets. These are not passive. The cable can use switches or hubs. Hubs can be passive but are not generally used.*

- ❑ Is OLT at home and ONU at the source?

*OLT at phone co. ONU at home.*

- ❑ Are cable and Fiber-to-the-Home installed at the same location in a neighborhood, for instance?

*There may not be any cable unless it is HFC.*

- ❑ What counts as active components? Can you give an example?

*Power makes a component active.*

# Fiber-To-The-Home (FTTH)

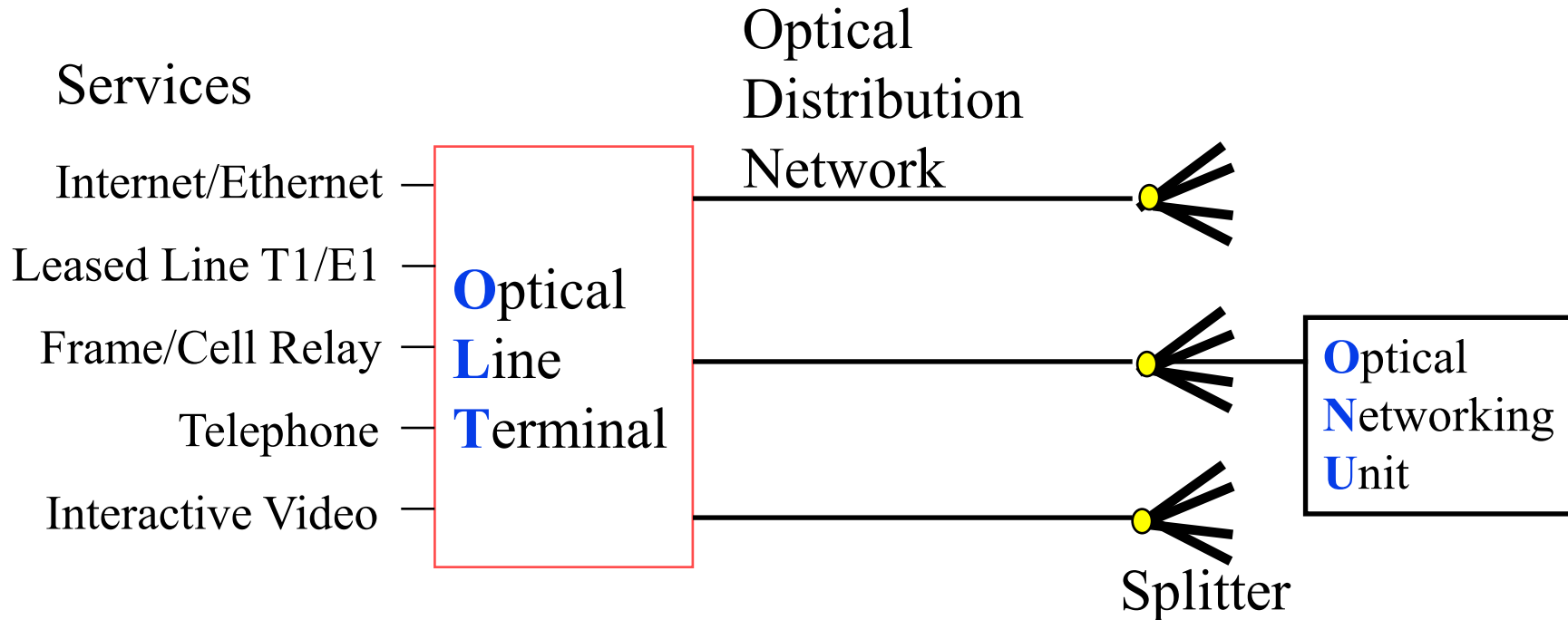

- ❑ 1+ Gbps per home. Multiple services.
- ❑ No electronic components in the distribution system  
⇒ Passive ⇒ Reliable
- ❑ Passive Optical Network (PON)

## Student Questions

- ❑ If we a fiber split into 5 and go to 5 different users. Then before the split, all the data for 5 people are combined together; is that correct?

*Each home has its own key and can only decrypt only its traffic.*

- ❑ You mentioned that OLT and ONU are active. Does that mean that if a user wants to quit, then the company can prevent him from stealing the network by ONU? Since the company won't uninstall the fibers from their home, right?

*OLT drops all packets from sources that have not paid*

- ❑ Does optical fiber not need repeaters? How far can an optical fiber signal propagate before degrading, or do they not degrade?

*They need repeaters but after a long distance.*

# Fiber-To-The-Home (FTTH)

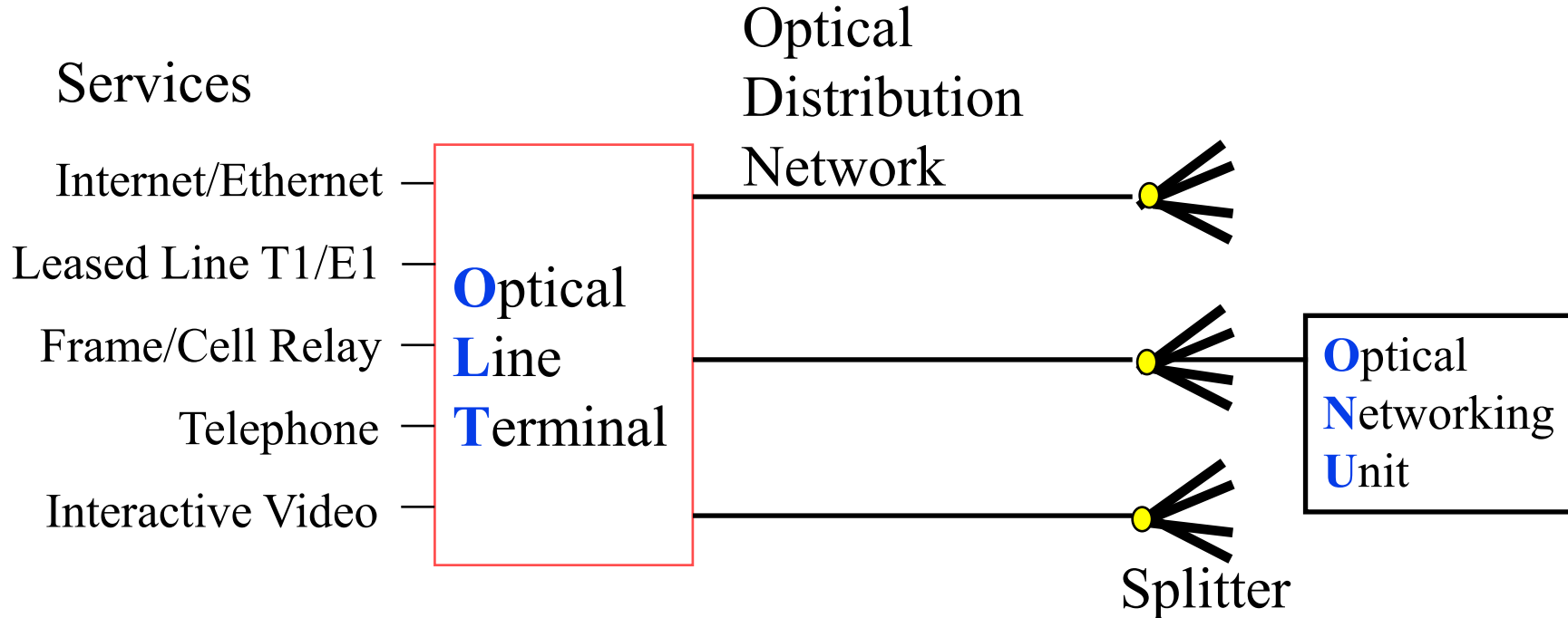

- ❑ 1+ Gbps per home. Multiple services.
- ❑ No electronic components in the distribution system  
⇒ Passive ⇒ Reliable
- ❑ Passive Optical Network (PON)

## Student Questions

- ❑ How is the optical signal split on fiber?

*Light naturally goes to all downstream paths.*

- ❑ Since it's a passive split, do we receive all the data and only use our key to decrypt the part corresponding to that key? Can we access other people's data without knowing their keys?

*Everyone knows where their part begins and ends. They can see others' parts but cannot decrypt those.*

- ❑ Is FTTH more common now?  
*Yes. I have FTTH.*

# Wireless Access Networks

- ❑ Wi-Fi hot spots
- ❑ Cellular access: 2G/3G/4G (LTE)

## Student Questions

- ❑ Can you explain what LTE is as well as 2G and 3G? Where on the EM Spectrum does LTE fall?  
*1G/2G/3G/4G/5G are all wireless telecom technologies. We will cover them briefly in Chapter 7. LTE is 3.9G or pre-4G. All of these currently use 700 MHz-5GHz spectra. The spectrum has to be purchased in Government Auctions.*

- 
- ❑ Can you explain the difference between LTE and 4G? Why LTE cannot be a single generation?  
*LTE tried but did not meet the 4G requirements. Discussed in detail in CSE574S.*



# Network Performance Measures

- ❑ Delay
- ❑ Throughput
- ❑ Loss Rate

## Student Questions

- ❑ Which of the Network Performance Measures are most used/valuable?

*Throughput*

---

- ❑ What's the difference between throughput and bandwidth?

*Throughput = bits/sec*

*Bandwidth = Hz*

*They are often used*

*interchangeably by many on the web.*

- ❑ Can we use bandwidth to evaluate the network performance?

*Throughput is more appropriate.*

# Network Performance Measures

- Delay
- Throughput
- Loss Rate

## Student Questions

# Throughput

- ❑ Measured in Bits/Sec
- ❑ Capacity: Nominal Throughput
- ❑ Throughput: Realistic
- ❑ Bottleneck determines the end-to-end throughput



Net end-to-end capacity = 10 Mbps

Actual throughput will be less due to sharing and overhead.

## Student Questions

- ❑ Can you define overhead?  
*Overhead = Throughput lost due to Packet headers and delays caused by routing.*  
*We will discuss these in the next few slides.*
- ❑ Is throughput a unidirectional measurement, or does it take into account two opposite and simultaneous data streams? *Throughput on each side is measured and may be different.*
- ❑ What causes overhead? *Packet headers and routing messages are examples of overhead.*
- ❑ What sorts of bottlenecks exist limiting E2E throughput?  
*Slow links, slow routers, slow end systems.*
- ❑ Can the total throughput (read and write) exceed the bandwidth of a network?  
*Throughput cannot exceed capacity.*
- ❑ What's the difference between throughput, capacity, and bandwidth?  
*Bandwidth relates to frequency. Capacity is the nominal throughput.*
- ❑ Is the throughput of a network equivalent to the speed of that network?  
*Speed=Capacity. Throughput=Actual output.*

# Throughput

- ❑ Measured in Bits/Sec
- ❑ Capacity: Nominal Throughput
- ❑ Throughput: Realistic
- ❑ Bottleneck determines the end-to-end throughput



Net end-to-end capacity = 10 Mbps

Actual throughput will be less due to sharing and overhead.

## Student Questions

❑ In a multi-hop connection such as the one shown in the figure, would packets travel at 10 Mbps over the whole link, or will the throughput change between each node?

*Throughput cannot exceed the capacity of intermediate links and nodes.*

- ❑ Do bottlenecks include the speed at which the computers/devices on the ends can transmit/receive packets too? *Yes.*
- ❑ Is the so-called bandwidth the same meaning as the throughput here?

*Often it is done but try to use the correct term.*

- ❑ Is the Net end-to-end capacity (Nominal throughput) determined by bandwidth

*Nominal = Design target*

# Throughput

- ❑ Measured in Bits/Sec
- ❑ Capacity: Nominal Throughput
- ❑ Throughput: Realistic
- ❑ Bottleneck determines the end-to-end throughput



Net end-to-end capacity = 10 Mbps

Actual throughput will be less due to sharing and overhead.

## Student Questions

- ❑ What is nominal throughput? What is the bottleneck? Can you elaborate on how sharing could affect throughput?

*Nominal = Design*

*Bottleneck = Slowest component*

- ❑ Does the highest TPS depend on the lowest capacity of transmitters, receivers, and wires? *Yes.*

# Loss Rate

- ❑ Queuing  $\Rightarrow$  Buffer overflow
- ❑ Bit Error Rate on the link
- ❑ Lost packets are retransmitted by the previous node or the source.

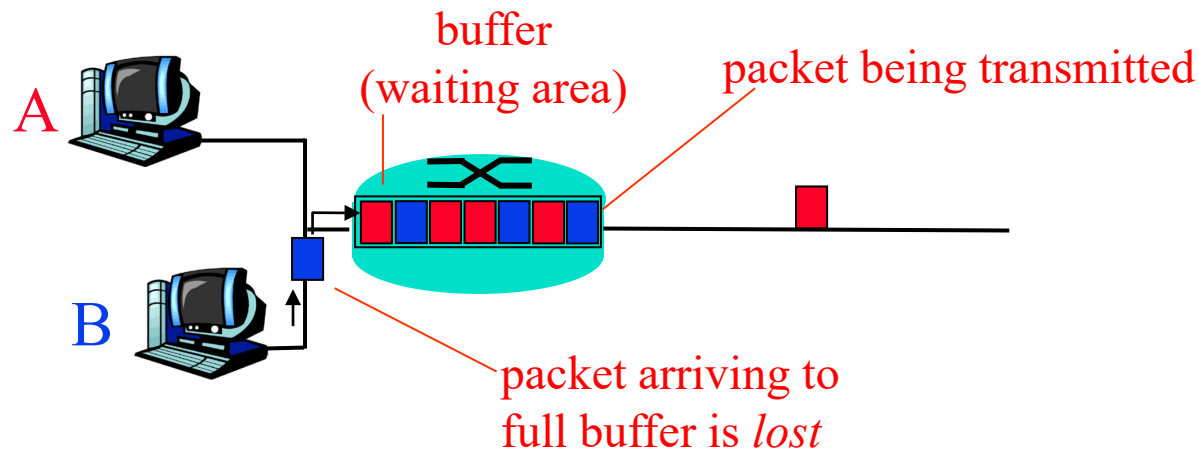

## Student Questions

- ❑ Is there any potential way to reduce the loss rate in wireless transmission?

*Use coding with lower bits/Hz.*

- ❑ What is packet loss? What causes packet loss?

*Errors.*

- ❑ Would you categorize loss rate as a characteristic of network performance, protocol, or both?

*Both. The network includes protocols.*

- ❑ If the buffer overflows, we lose packets, and if a bit error occurs, that packet gets dropped.

*Yes.*

- ❑ How can you reduce the Loss rate?

*By designing to reduce errors and overflow.*

# Loss Rate

- ❑ Queuing  $\Rightarrow$  Buffer overflow
- ❑ Bit Error Rate on the link
- ❑ Lost packets are retransmitted by the previous node or the source.

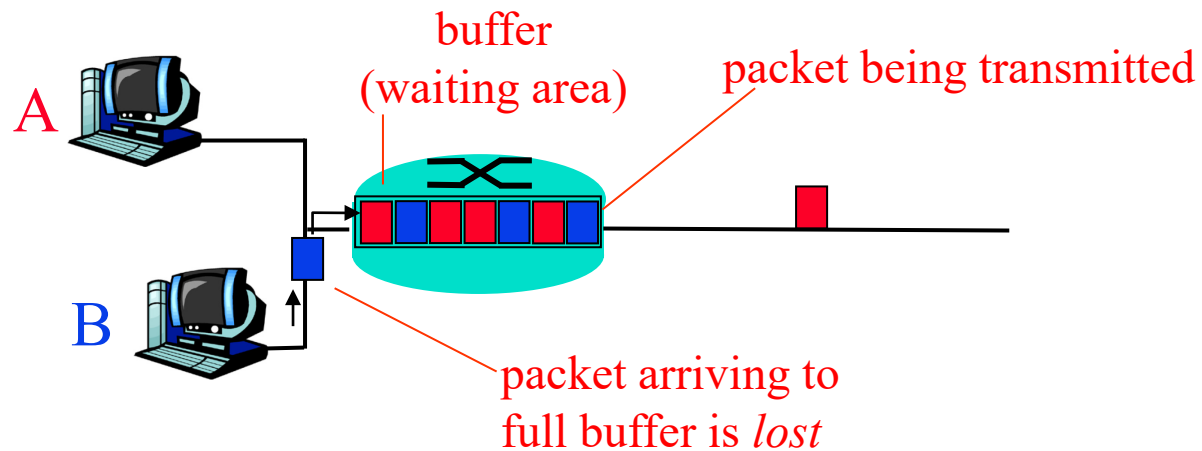

## Student Questions

- ❑ How would the source node know that some bits are lost?  
*Every packet has a number and a length*
- ❑ Can interference or hardware malfunctions cause packet loss, or are these problems a separate issue?

*Yes. They have a similar effect.*

# Packet Switching Delay

1. **Processing Delay:** Check packets, decide where to send, etc.
2. **Queuing Delay:** Wait behind other packets
3. **Transmission Delay:** First-bit out to last-bit out on the wire  
= **Packet Length/bit rate**
4. **Propagation Delay:** Time for a bit to travel from in to out  
= **Distance/speed of signal**
5. **Speed of Signal:** **300 m/μs** light in vacuum, **200 m/μs** light in fiber, **250 m/μs** electricity in copper cables

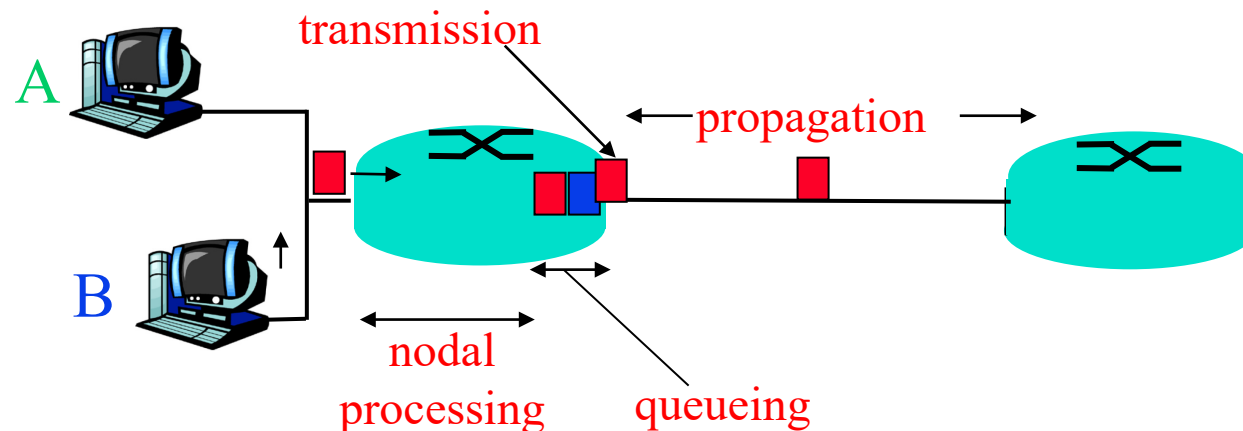

## Student Questions

- ❑ The optical signal travels faster than electricity because light can carry intensive signals on the fiber?

*Optical signal in fiber travels slower than electricity due to the refractive index of the fiber.*

- ❑ Optical fibers have a larger capacity, and copper cables have less delay. Is that correct?

*Yes.*

- ❑ Does always wired better than wireless in terms of throughput, delay, and loss rate?

*For the same cost, yes. Some wireless networks are faster than some wired networks, but they are more expensive.*

- ❑ Is propagation delay always happen "after" transmission delay? Do we have to put every bit on the wire first before the first bit is sent to the destination, or can we send it as we go?

*Bits cannot be stopped on the wire. They travel as soon as entering the wire.*

- ❑ Does the delay affect the throughput?

*Two metrics have a complex relationship. They do not affect each other.*



# Packet Switching Delay

1. **Processing Delay:** Check packets, decide where to send, etc.
2. **Queuing Delay:** Wait behind other packets
3. **Transmission Delay:** First-bit out to last-bit out on the wire  
= **Packet Length/bit rate**
4. **Propagation Delay:** Time for a bit to travel from in to out  
= **Distance/speed of signal**
5. **Speed of Signal:** **300 m/μs** light in vacuum, **200 m/μs** light in fiber, **250 m/μs** electricity in copper cables

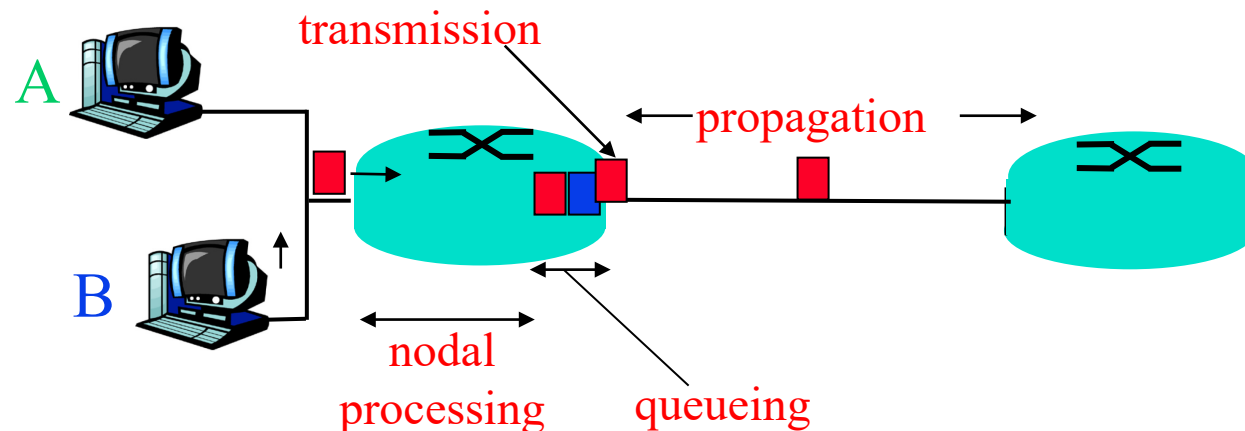

## Student Questions

- ❑ Are all the delays series connections or parallel connections?

*Delays on a series of links add up.*

- ❑ Which kind of delay has the greatest impact on signal transmission?

*It depends on whichever is larger.*

- ❑ What causes packets to get lost in wired mediums?

*Bit errors.*

- ❑ What is the difference between Ethernet and IP?

*To be covered later.*

- ❑ Are there any other options that are “in-between” a copper and fiber cable? Or some hybrid cable?

*I am not aware.*

# Packet Switching Delay

1. **Processing Delay:** Check packets, decide where to send, etc.
2. **Queuing Delay:** Wait behind other packets
3. **Transmission Delay:** First-bit out to last-bit out on the wire  
= **Packet Length/bit rate**
4. **Propagation Delay:** Time for a bit to travel from in to out  
= Distance/speed of signal
5. **Speed of Signal:** **300 m/μs** light in vacuum, **200 m/μs** light in fiber, **250 m/μs** electricity in copper cables

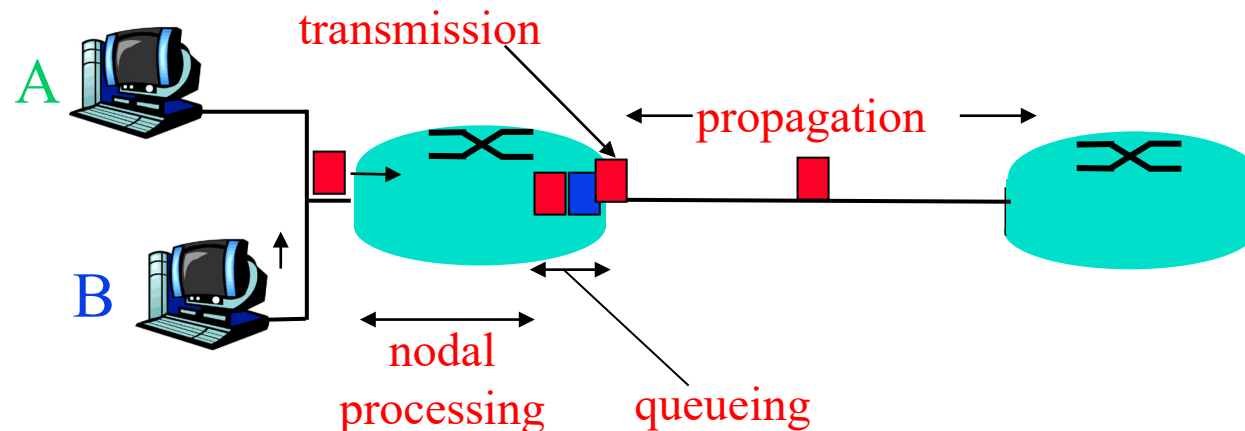

## Student Questions

- ❖ Will we face problems, including queuing delay in the exam?

*Only to the extent it is covered in the book.*

# Packet Switching Delay: Example

- ❑ 1500 Byte packets on 10 Mbps Ethernet, 1km segment
- ❑ Transmission Delay =  $1500 \times 8 / 10 \times 10^6 = 1200 \mu\text{s} = 1.2\text{ms}$
- ❑ Propagation delay =  $1000 \text{ m} / 2.5 \times 10^8 = 4 \mu\text{s}$

## Student Questions

- ❑ Will there be any sort of formula sheet accompanying our exams for math *questions where they may be relevant?*

*One cheat sheet of 8.5x11" paper is allowed in the exam. But you will be better off remembering some of the common constants and formulas.*

- ❑ Does  $2.5 \times 10^8$  come from electricity speed? Are we assuming Ethernet uses a copper cable?

*Yes.*

---

- ❑ Is this mean that we use the speed of electronic travel through the copper if not declared?

*Yes*

# Delay Example (CBR Circuits)

- ❑ How long would it take to send a file of 640,000 bits from host A to host B over a circuit-switched network?
  - All links are 1.536 Mbps
  - Each link is shared by 24 users
  - 500 ms to establish an end-to-end circuit
- ❑ Per User Rate =  $1536/24 = 64$  kbps
- ❑ Time to transfer =  $640\text{kb}/64\text{kb} = 10$  s
- ❑ Total time =  $.5$  s +  $10$  s =  $10.5$  s

## Student Questions

- ❑ Are we assuming the link is using TDM? Wouldn't every user get 1.536 Mbps if it were FDM?

*In FDM, the bit/sec depends on Hertz. Hertz is the unit of frequency. So dividing frequency divides the bit rate among users even in FDM.*

- ❑ I don't quite understand why FDM will divide the bit rate as well as TDM. Could you give more explanations about it?

*Two users are sharing 10 MHz for 1 second. Assume one bit/Hz as an example. Each will get 5 Mbps for 1 second using FDM or 10 Mbps for 0.5 s using TDM.*

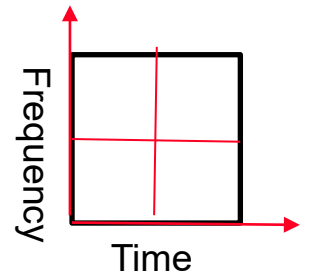

- ❑ Can we reuse the unoccupied channel in circuit-switched networks?

*Unoccupied, yes. Unused, No.*

# Homework 1B: Network Performance

P5 [14 points]: Consider two hosts, A and B, connected by a single link of rate  $R$  bps. Suppose that the two hosts are separated by  $m$  meters, and suppose the propagation speed along the link is  $s$  meters/sec. Host A is to send a packet of size  $L$  bits to Host B.

- A. Express the propagation delay,  $d_{prop}$  in terms of  $m$  and  $s$
- B. Determine the transmission time of the packet  $d_{trans}$  in terms of  $L$  and  $R$ .
- C. Ignoring processing queuing delays, obtain an expression for the end-to-end delay
- D. Suppose Host A begins to transmit the packet at time  $t=0$ . At time  $t=d_{trans}$ , where is the last bit of the packet?
- E. Suppose  $d_{prop}$  is greater than  $d_{trans}$ . At time  $t=d_{trans}$ , where is the first bit of the packet?
- F. Suppose  $d_{prop}$  is less than  $d_{trans}$ , at time  $t=d_{trans}$ , where is the first bit of the packet
- ⇒ G. Suppose  $s=3 \times 10^8$  m/s,  $L=290$  bits, and  $R=60$  kbps,. Find the distance  $m$  so that  $d_{prop}$  equals  $d_{trans}$ .

## Student Questions

- To clarify, should  $L$  be 280 bits for part G?

*No, it is 290.*

- ❖ same question, what would happen if A and B are not connected by a single link, but through several links?

*You will have to compute delays on each link.*

# Protocol Layers

- ❑ Problem: Philosophers in different countries speak different languages. The Telex system works only with English.

I believe there is a God!

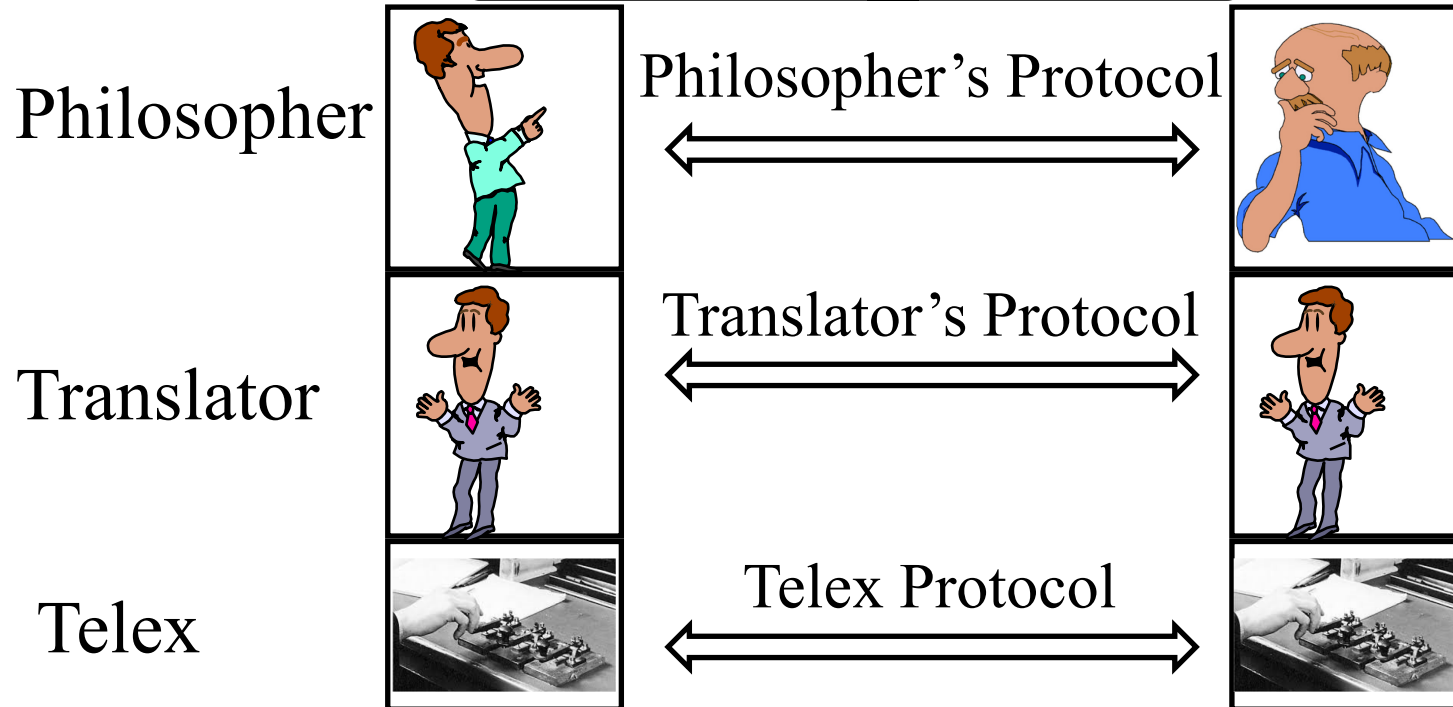

## Student Questions

- ❑ Are there any protocols between philosopher and translator or between translator and telex?

*Yes, those are called APIs. Not protocols.*

# What is a Networking Protocol?

- Network protocols define the format of messages, their meanings, sequence, and actions



## Student Questions

# ISO/OSI Reference Model

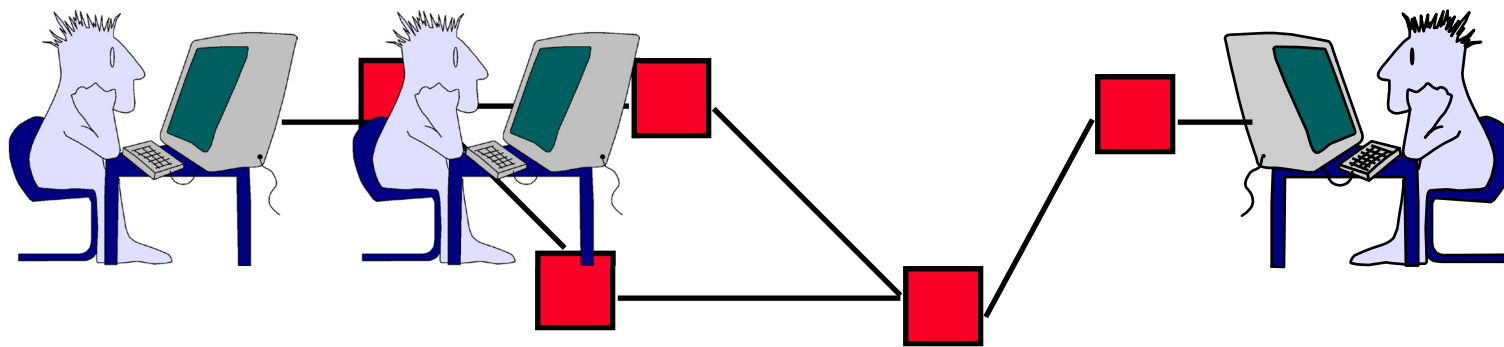
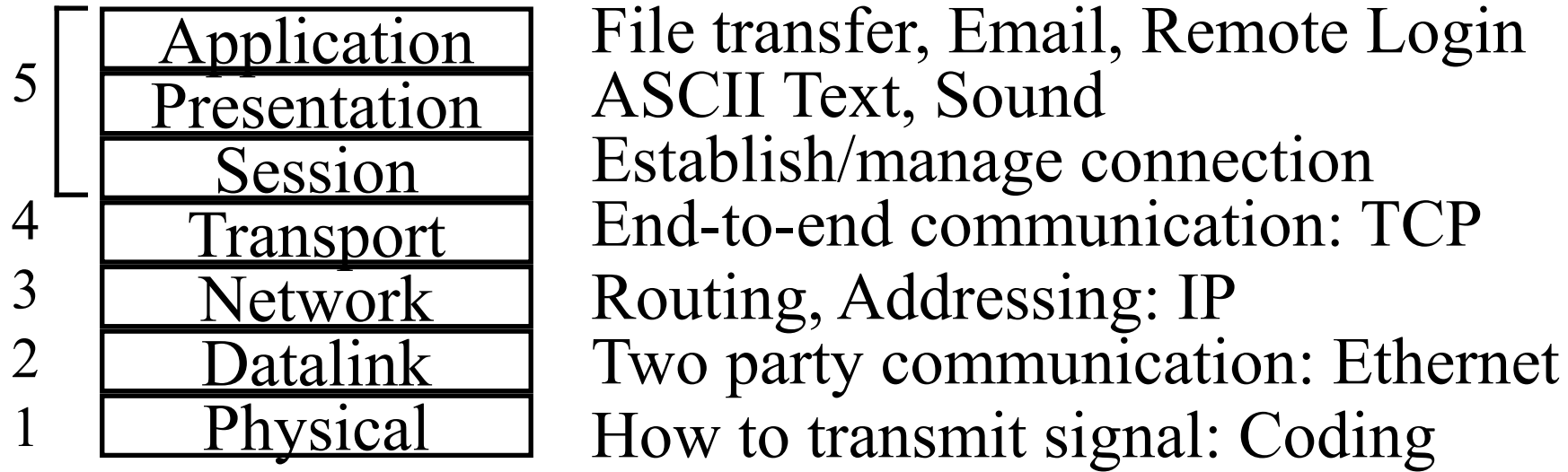

## Student Questions

- Layer 2 and Layer 4 sound pretty similar to me. Both of them focus on communication. Could you help me distinguish them?

*One link vs. one path*

*A path has many links on the way. The same functions require different solutions since the latencies are different.*

- Would you clarify what the data link and session levels are responsible for?

*Data link = One link*

*Session = One application*

- Is there an example of a "Session protocol" or is that not a thing at all?

*Mail and HTTP are examples of applications. In TCP, application, presentation, and session layers are combined as one.*

- What layers connection does "ping" check? Sometimes we can ping a website, but we cannot see the content of the website in the browser. *Layer 3*
- Are layers interconnecting with each other before communicating? *As soon as a layer has been initialized, it is ready to talk.*



# ISO/OSI Reference Model

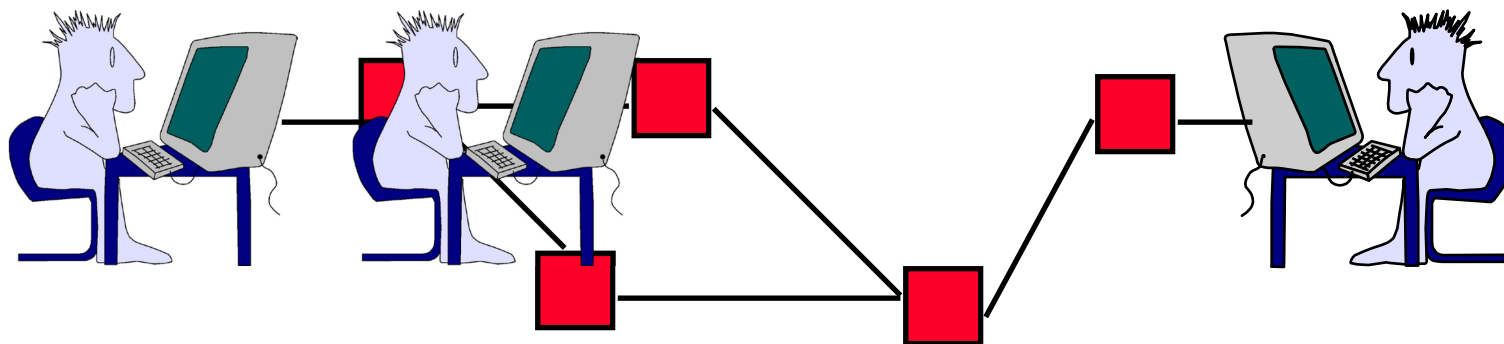
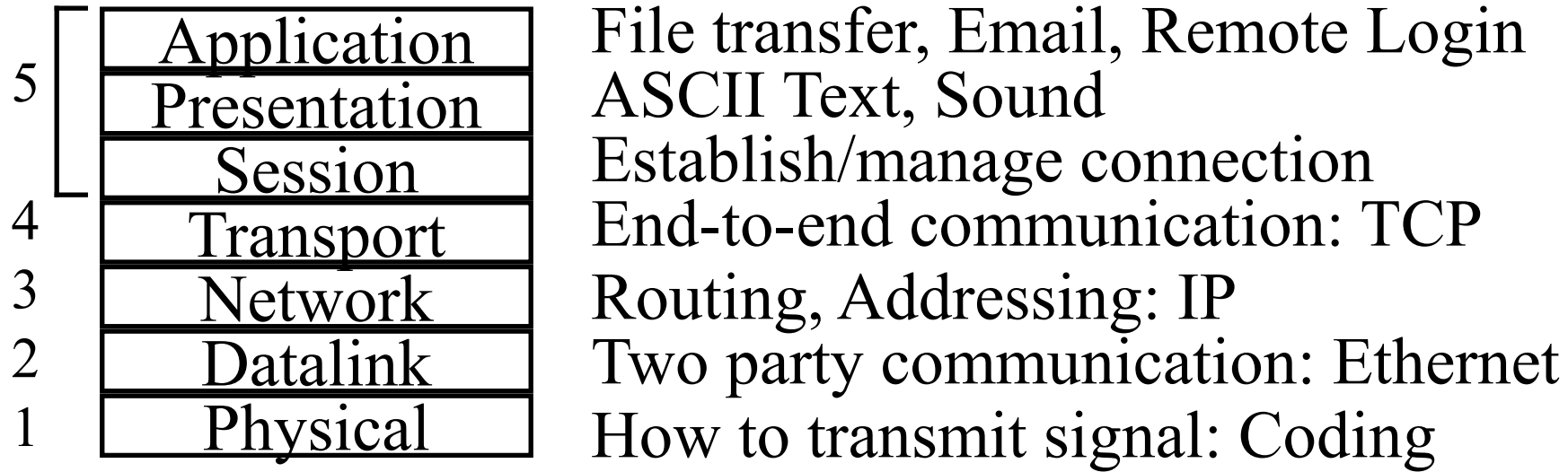

## Student Questions

- ❑ Is there any specific order for the layers? For example, the session layer has to be before the transport layer. *Yes.*
  - ❑ Is combining or separating the application, presentation, and session layer dependent on the protocol? *Yes. TCP combines all of these.*
  - ❑ Should we see the model top to bottom or bottom to top? *This textbook covers top-down. Other books cover bottom-up.*
  - ❑ In a modern server, which layers are handled by the operating system?
- Up to Layer 4.*
- ❑ Layer 5 was composed of application, presentation, and session. Is there any connection between them?

*Yes. It all depends on the application.*  
Which layers of OSI is the router we use on?  
*Layer 3.*

- ❑ Where can we get the handout?

*Course website:*

<http://www.cse.wustl.edu/~jain/cse473-23/index.html>

# ISO/OSI Reference Model

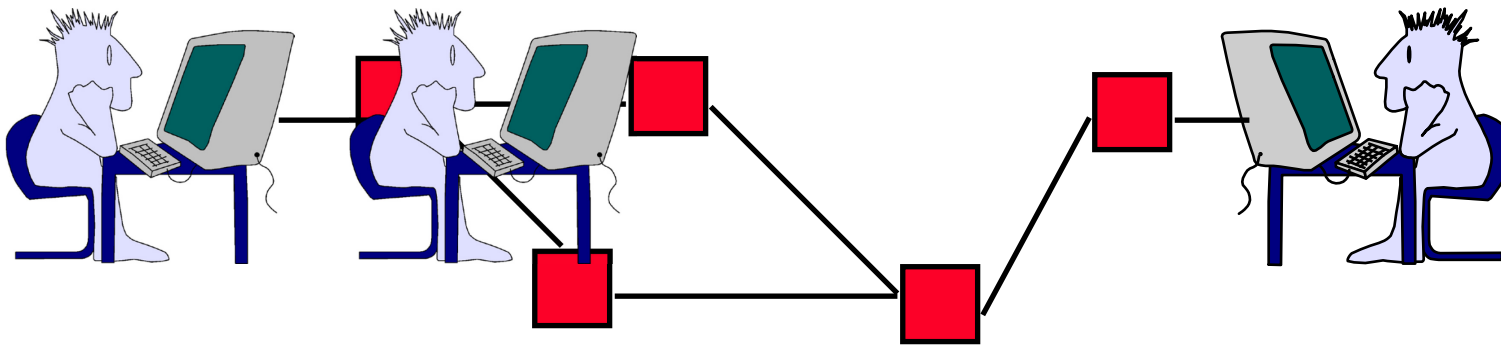
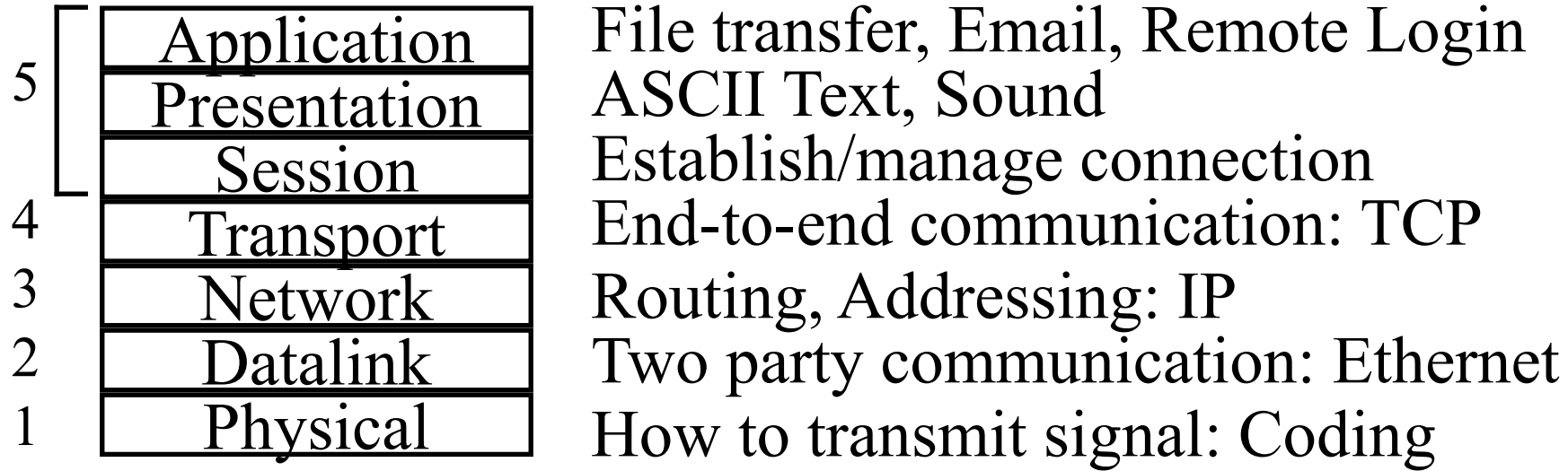

## Student Questions

- ❑ Since the transport layer does end-to-end communication, what does the network layer do?

*Find the path (Routing)*

- ❑ Does this 5-layer model have any connection with the 4-layer TCP/IP model?

*They are same. 1+2 might be combined.*

- ❑ Why is the ISO model taught instead of the TCP/IP model? Is it just easier to understand?

*It is also used in many topics.*

- ❑ Why are layers 5, 6, and 7 grouped?

*They are tightly connected.*

# ISO/OSI Reference Model

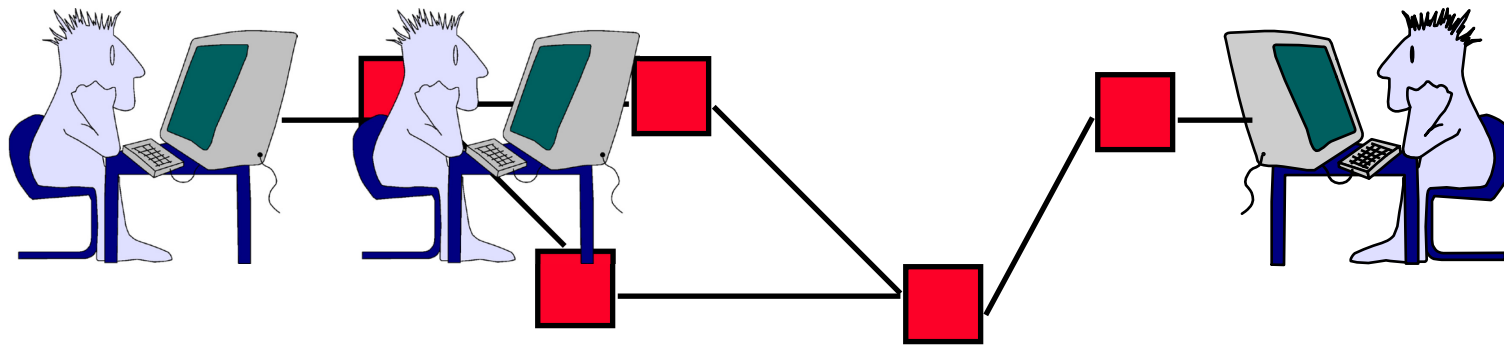
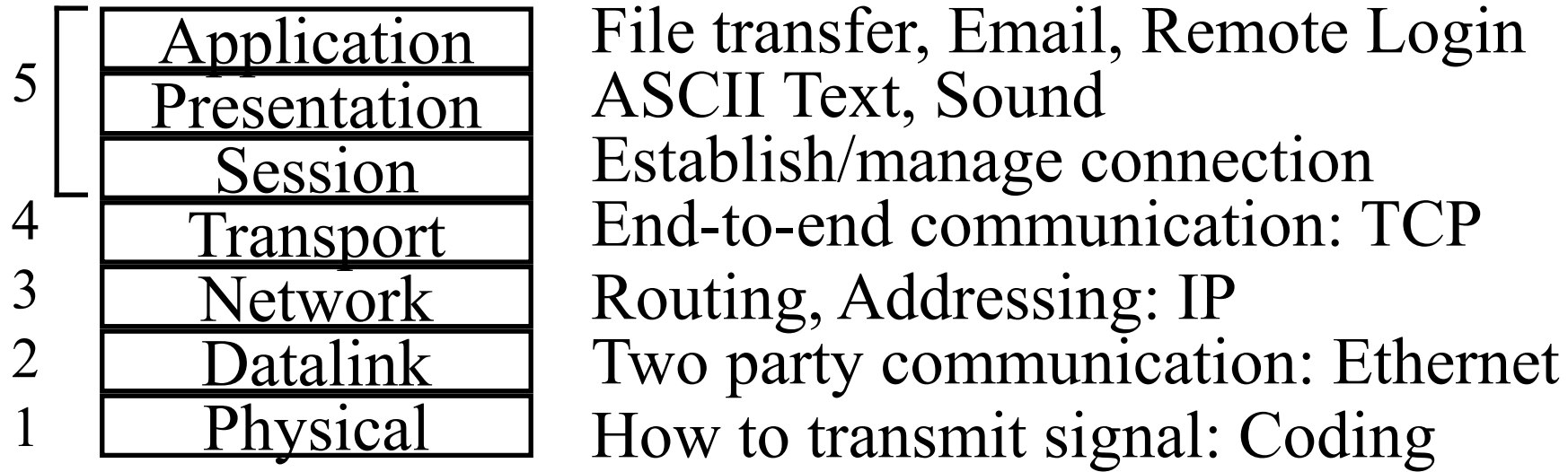

## Student Questions

- Why is the 5<sup>th</sup> layer designed with 3 components? What made them design it like this?  
*They are tightly connected.*

# Service and Protocol Data Units

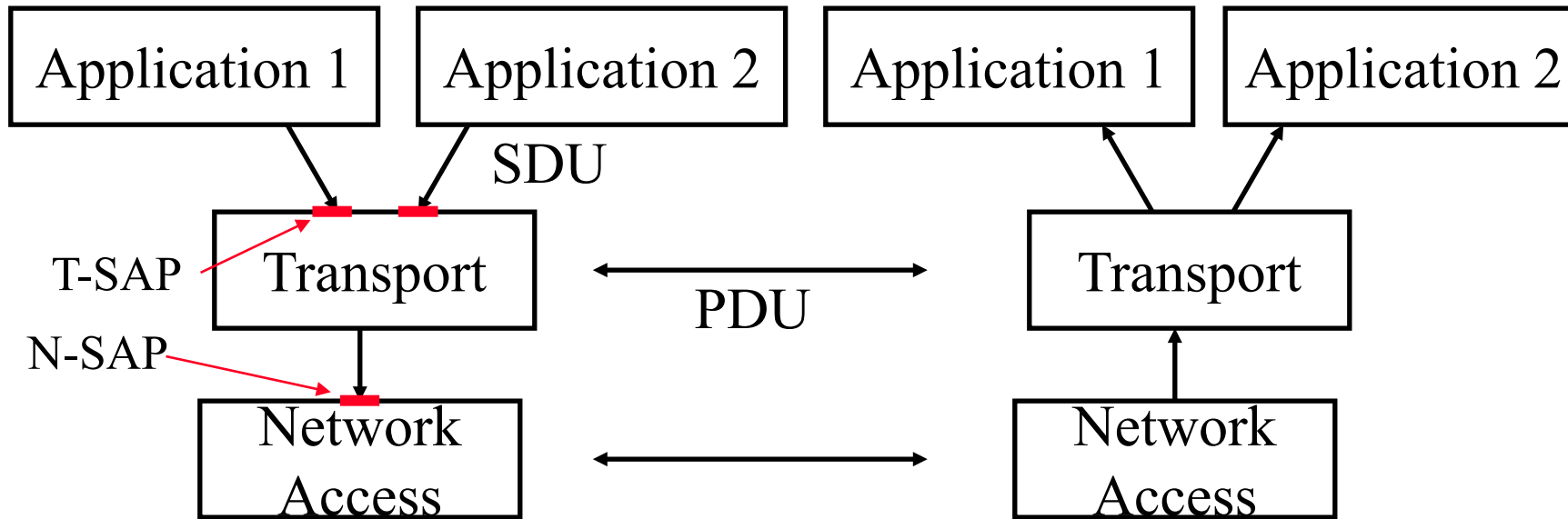

- ❑ Service Access Points (SAPs)
- ❑ Service Data Units (SDUs)
- ❑ Protocol Data Units (PDUs)

## Student Questions

- ❑ What are Service Access Points (SAPs)?  
*See the updated figure on the left.*  
*Ports are examples of T-SAPs (Transport SAPs)*
- ❑ Could SAP be described as an API of a different layer? *Yes. SAP=API of a layer.*
- ❑ You said SDU goes down vertically over the layer, and PDU goes horizontally over the same layers. But I remember the procedure of data transmission is to first go down to the physical layer, the router, then the physical layer of another host when it finishes. This is contradicted by what the slide refers to. Could you explain?

*You are right. The PDUs are units of information exchanged by modules of one layer. But they have to go down vertically, travel horizontally, then vertically up.*

- ❑ Do the arrows between Transport and Network Access imply that Transport PDUs are bidirectional while Network PDUs are not?

*Corrected.*

# Service and Protocol Data Units

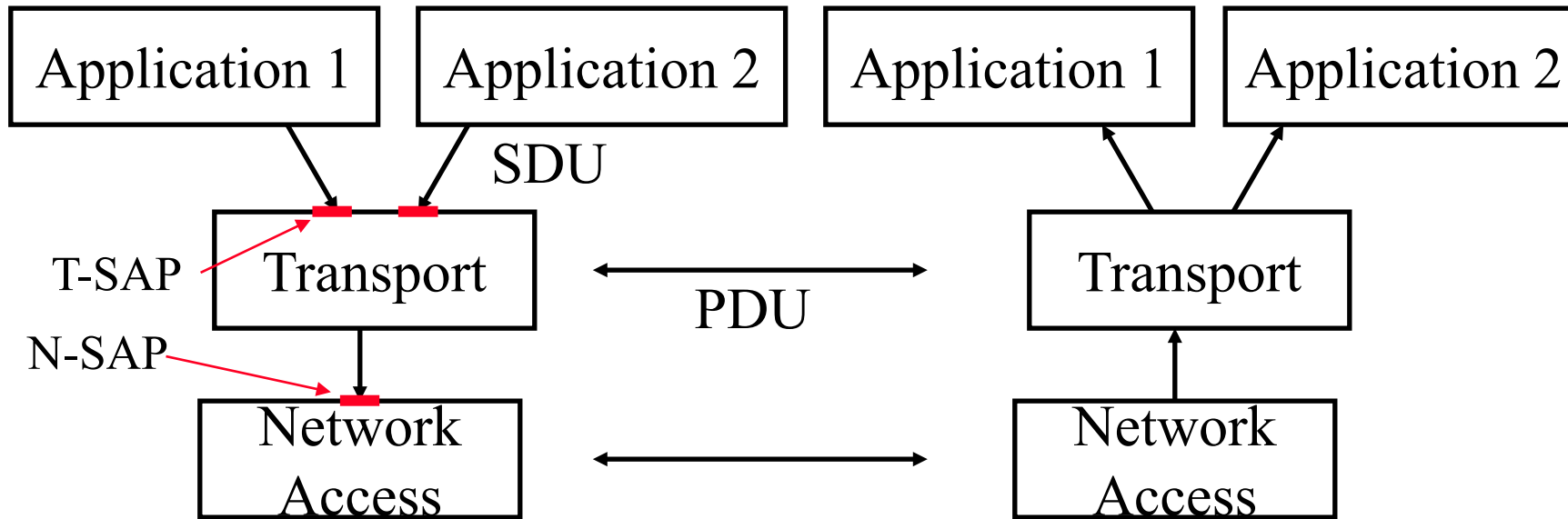

- ❑ Service Access Points (SAPs)
- ❑ Service Data Units (SDUs)
- ❑ Protocol Data Units (PDUs)

## Student Questions

- ❑ Do the arrows between Transport and Network Access imply that Transport PDUs are bidirectional while Network PDUs are not?

*Corrected.*

- ❑ Can you explain more about how PDU works? What do you mean PDU goes horizontally?

*In the same layer, e.g., layer 3 to layer 3.*

- ❑ Are PDUs and SDUs just simple bits? Or are they packets?

*They are packets*

- ❑ In the diagram, why are there PDUs on the T and N layer but not on any other

*They apply to all layers.*

# Service and Protocol Data Units

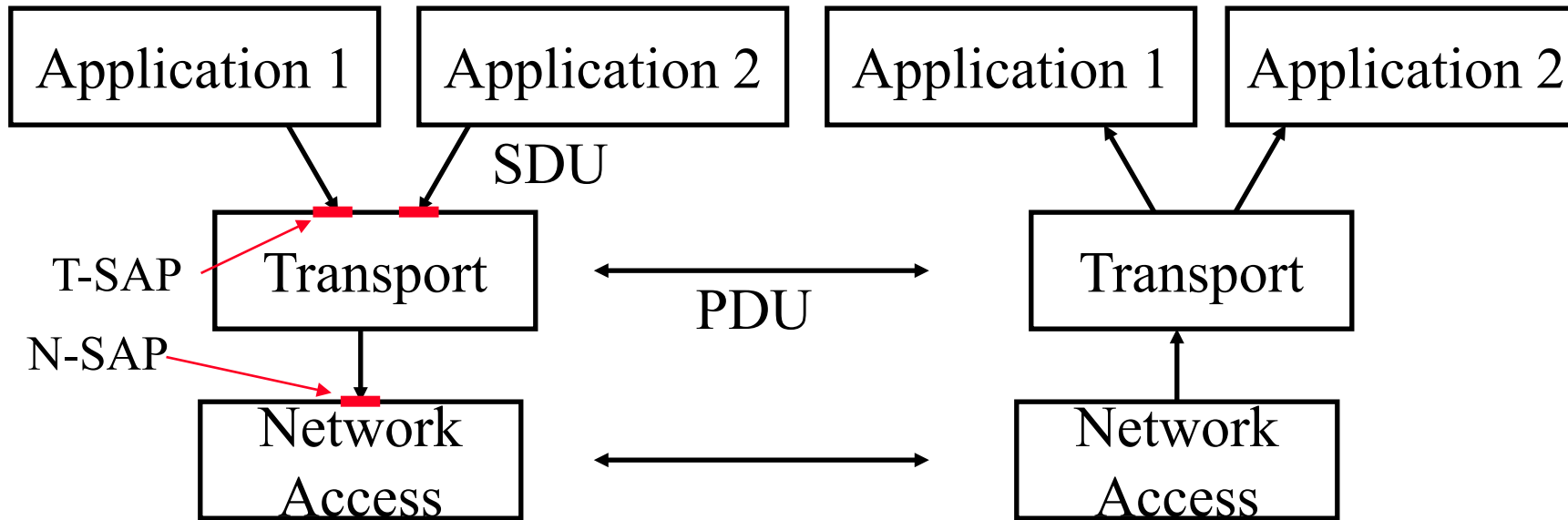

- ❑ Service Access Points (SAPs)
- ❑ Service Data Units (SDUs)
- ❑ Protocol Data Units (PDUs)

## Student Questions

- ❑ Can you give an example of a PDU needing to be used?  
*PDUs are packets.*
- ❑ Does data unit mean packet? And is the service data unit vertical, and is the protocol data unit horizontal?  
*Yes.*
- ❖ What is the difference between SAP and SDU? And what do they do each?  
*SDUs are packets. Packets enter through Service access points.*

# Service Data Unit (SDU)

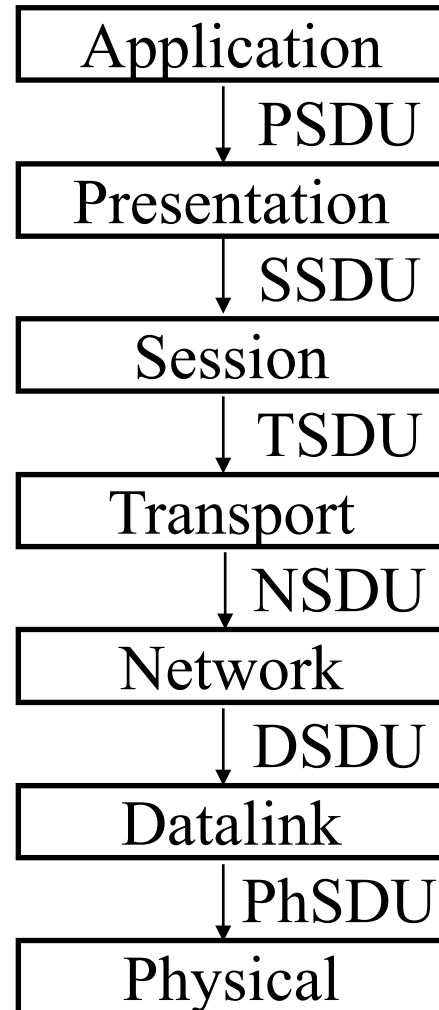

## Student Questions

- Can a layer communicate only with layers directly above and below it, or can it skip layers?

*In a strictly layered architecture, the communication is between successive layers only. Although not common, cross-layer communication has been studied and applied to some special situations.*

- Are the SDU and PDU for each layer different actual bit patterns? Is the incoming SDU translated into a PDU for that protocol layer, which is then translated to the SDU for the next layer and transmitted?

*Yes, SDUs and PDUs are different for different layers. PDUs are formed by combining or fragmenting SDUs. Each PDU has a header that is understood by the other side.*

- For PDU, does one layer send data directly to another similar layer, or just transmit to the bottom layer vertically, then send in the physical layer, and finally go up vertically to the target layer?

*Yes. PDUs go to the bottom layer and then across.*

# Service Data Unit (SDU)

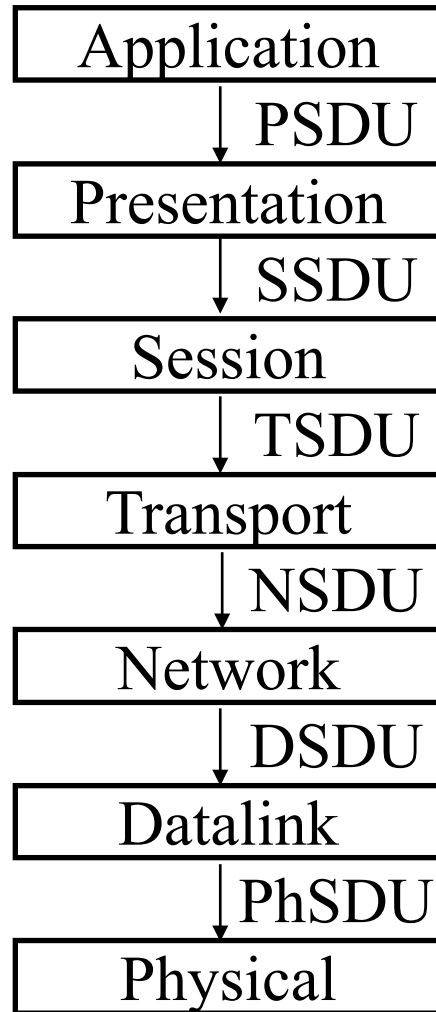

## Student Questions

□ Why can't they just use one type of data unit to unify SDU and PDU?

*They are different.*

□ Are the names the same if they are being passed up the ladder?

*Yes*



# Protocol Data Unit (PDU)

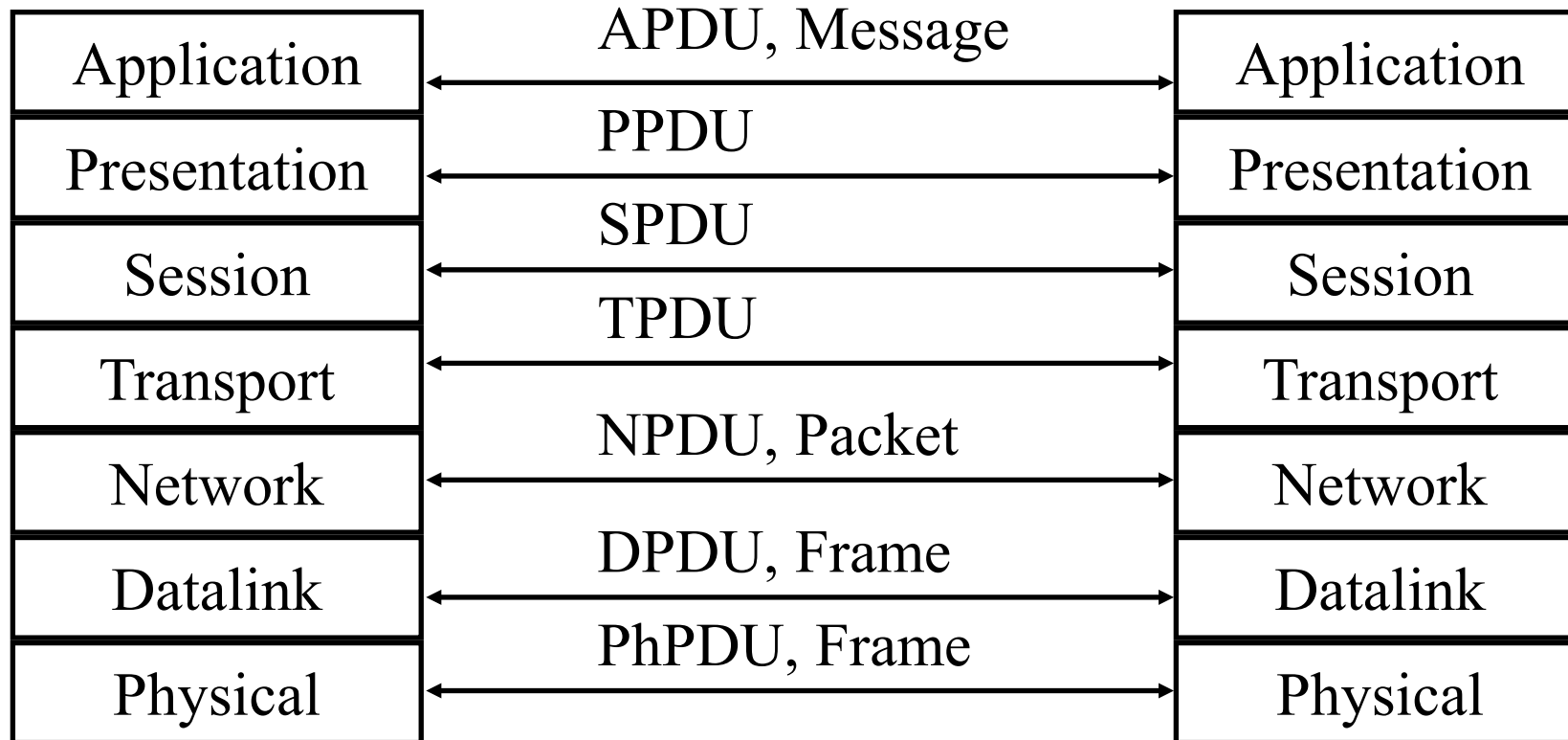

## Student Questions

- ❑ What is the difference between SDUs and PDUs?  
*Service data units go down vertically between different layers.*  
*Protocol data units flow horizontally between the entities in the same layer.*
- ❑ If a message must go down through all the layers before being transmitted, why do layers besides the lowest one have PDUs?  
*Each has a format that is understood only by that layer.*

# TCP/IP Reference Model

- ❑ TCP = Transmission Control Protocol
- ❑ IP = Internet Protocol (Routing)

TCP/IP Ref Model

Application
Transport
Internetwork
Host to Network
Physical

TCP/IP Protocols

FTP	Telnet	HTTP
TCP		UDP
IP		
Ethernet	Point-to-Point	Packet Radio
Coax	Fiber	Wireless

## Student Questions

- ❑ TCP is "Transmission Control Protocol" and IP is "Internet Protocol", is "TCP/IP Protocol" not good since "Protocol" is repeated?

*TCP/IP is a "protocol suite."*

- ❑ What is the V for in IPV?

*IPv4 = IP version 4*

*IPv6 = IP version 6*

# OSI vs TCP/IP

OSI	TCP/IP
Application	Application
Presentation	
Session	
Transport	Transport (host-to-host)
Network	Internet
Data Link	Network Access
Physical	Physical

## Student Questions

- ❑ How is the session layer from the OSI model split up between the application and transport layers of the TCP/IP model?

*Some functions of the session layer are in TCP, and some are not. It doesn't really matter since TCP is now universal, along with a few other similar transports.*

- ❑ What is the difference between the OSI model and the TCP/IP model? I've looked at so many different websites' explanations but still don't understand...

*OSI was done after TCP/IP. However, by the time OSI was partially completed, TCP/IP was universally implemented. So OSI is more methodical but nonexistent. TCP/IP is less methodical but everywhere.*

- ❑ Should we be comfortable with both the OSI and TCP/IP models, or is it sufficient to only be comfortable with the TCP/IP model?

*You should know as much about the OSI model as discussed in this class video and Q&As.*

---

# OSI vs TCP/IP

OSI	TCP/IP
Application	Application
Presentation	
Session	
Transport	Transport (host-to-host)
Network	Internet
Data Link	Network Access
Physical	Physical

## Student Questions

- Is the TCP/IP model used now, and the OSI model is obsolete? *Yes.*
- Can I say that the OSI model distinguishes the session layer and application layer, but from a real-world programmer point of view, sessions are part of the application layer?

*Real-world applications need particular session layer functions and cannot run on different layers.*

- Is OSI still used in any places? *Many OSI protocols and OSI terms are still helpful and used.*

# OSI vs TCP Reference Models

- ❑ OSI introduced concept of services, interface, protocols. These were force-fitted to TCP later  
⇒ It is not easy to replace protocols in TCP.
- ❑ In OSI, reference model was done before protocols. In TCP, protocols were done before the model
- ❑ OSI: Standardize first, build later  
TCP: Build first, standardize later
- ❑ OSI took too long to standardize. TCP/IP was already in wide use by the time.
- ❑ OSI became too complex.
- ❑ TCP/IP is not general. Ad hoc.

## Student Questions

- ❑ Does there not need to be one agreed-upon model among all telecommunication services/companies?

*Everyone's needs are different.*

---

- ❑ What happens when a host detects packet loss?

*It may ask the source to retransmit.*

# PDU's in TCP/IP Architecture

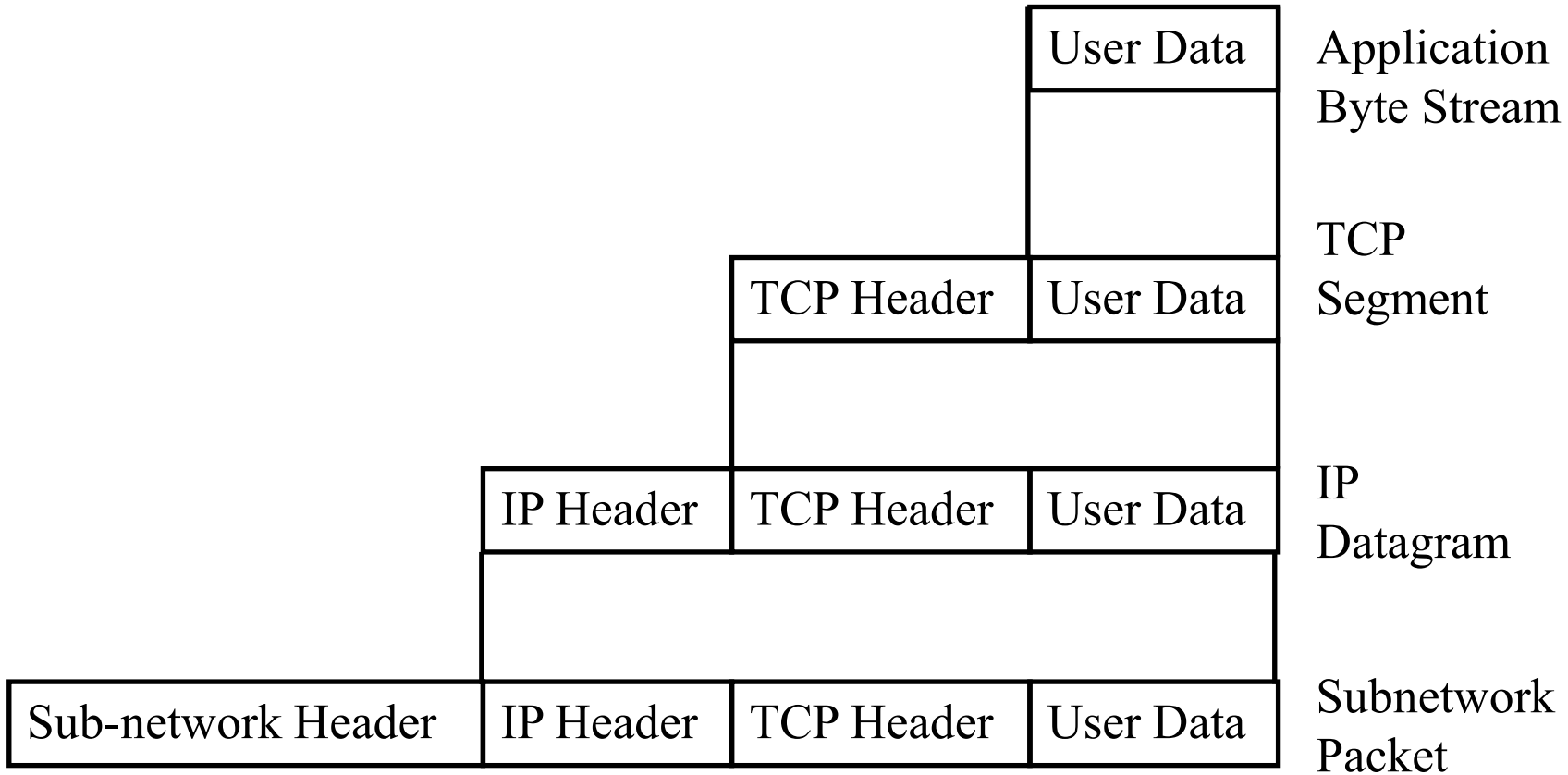

## Student Questions

- ❑ If the TCP is not full yet, can it still send the message?

*Yes, based on a timer.*

- ❑ What does header mean?

*The header contains information that the other side needs.*

- 
- ❑ Are headers attached to data when it travels down the network layers?

*Yes.*

- ❑ Is there ever encryption between any of these steps?

*Encryption is usually done in the end-to-end (transport) layer.*

# TCP/IP Applications

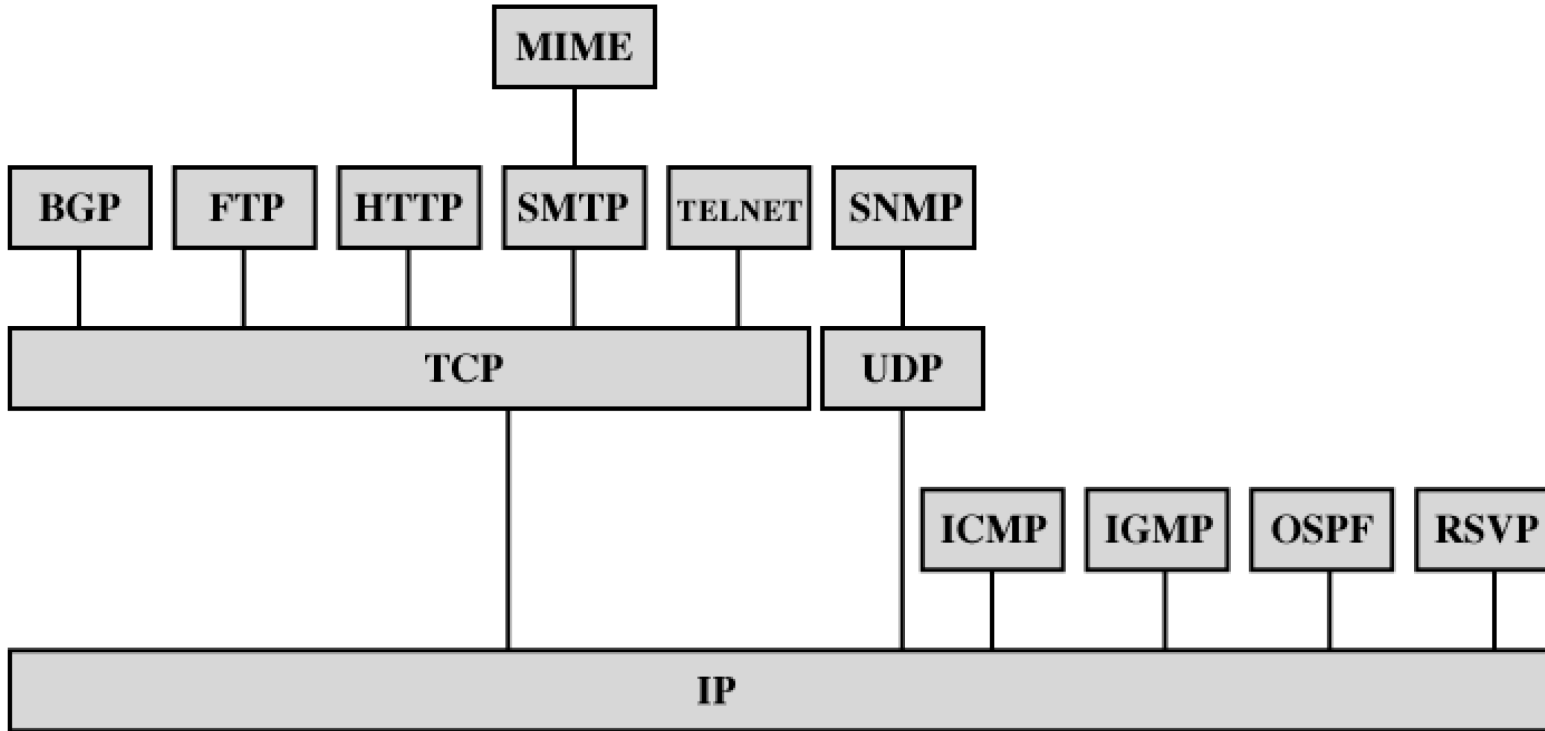

BGP = Border Gateway Protocol  
FTP = File Transfer Protocol  
HTTP = Hypertext Transfer Protocol  
ICMP = Internet Control Message Protocol  
IGMP = Internet Group Management Protocol  
IP = Internet Protocol  
MIME = Multi-Purpose Internet Mail Extension

OSPF = Open Shortest Path First  
RSVP = Resource ReSerVation Protocol  
SMTP = Simple Mail Transfer Protocol  
SNMP = Simple Network Management Protocol  
TCP = Transmission Control Protocol  
UDP = User Datagram Protocol

## Student Questions

- ❑ Will we be expected to memorize all of these protocols and if they run on TCP/IP/SMTP/etc.?

*Not yet. However, in later modules, we cover some of these protocols. Then you will need to know what runs below and above. This is just a preview and lists too many protocols.*

- ❑ Is it correct that because the HTTP layer is above TCP, it is responsible for giving the TCP layer the properly formatted message?

*Yes.*

- ❖ *As shown in the figure, Is TCP included in IP?*

*No. It uses IP.*

# Network Security

- ❑ Security Components
- ❑ Types of Malware
- ❑ Types of Attacks
- ❑ Buffer Overflows
- ❑ Distributed DoS Attacks

## Student Questions

- ❑ In my background, I found any attack on any part of an arbitrary company's security system starts with loading up the main site and seeing what's publicly available to look at. Checking the place out often leads to best-case some goal achieved and worst-case information useful for an exploit, I have heard at times and in places before. Why wouldn't simply looking around be the first step of an arbitrary attack, network security-related or otherwise?

*Snooping is the first step of an attack.*



# Security Components

- ❑ **Confidentiality**: Need access control, Cryptography, Existence of data
- ❑ **Integrity**: No change, content, source, prevention mechanisms, detection mechanisms
- ❑ **Availability**: Denial of service attacks,
- ❑ Confidentiality, Integrity and Availability (**CIA**)



## Student Questions

- ❑ Does maintaining a security component (e.g., integrity) require the knowledge of the result (e.g., file has been verified with a checksum), or is it enough to know that you have enacted countermeasures and you have not detected any tampering?

*Maintaining a component requires that that component be verified and ensured.*

---

# Types of Malware

- ❑ **Viruses:** Code that *attaches* itself to programs, disks, or memory to propagate itself.
- ❑ **Worms:** Installs copies of itself on other machines on a network, e.g., by finding user names and passwords
- ❑ **Trojan horses:** Pretend to be a utility. Convince users to install it on their PC.
- ❑ **Spyware:** Collect personal information

This is not a complete list.

## Student Questions

- ❑ Worms and viruses don't sound mutually exclusive based on the definitions given. The difference is only in how they arrive on your system?

*Yes, viruses can fly but worms can only walk.*

- ❑ Can viruses or worms be transported through trojan horses?

*Yes.*

- ❑ These are not mutually exclusive, right? A piece of malware could be any/all of these.

*Yes. A virus could be spyware.*

# Types of Attacks

- ❑ **Denial of Service (DoS):** Flooding with traffic/requests
- ❑ **Buffer Overflows:** Error in system programs. Allows hackers to insert their code into a program.
- ❑ **Malware**
- ❑ **Brute Force:** Try all passwords.
- ❑ **Port Scanning:**  
⇒ Disable unnecessary services and close ports
- ❑ **Network Mapping**

## Student Questions

- ❑ How would you protect against something like a Buffer Overflow attack on the network layer?

*Good code writing.*

- ❑ How to do port scanning?

*We will show you later in the security chapter.*

---

- ❑ Are DDoS attacks common on popular sites like YouTube? Are they effective?

*Yes. Yes.*

- ❑ Are there other types of DoS attacks that are not DDoS?

*Attacks from a single node to a single node are non-DDoS.*

# Distributed DoS Attacks

- ❑ **Tribe Flood Network** (TFN) clients are installed on compromised hosts.
- ❑ All clients start a simultaneous DoS attack on a victim on a trigger from the attacker.
- ❑ **Trinoo** attack works similarly. Use UDP packets. Trinoo client report to Trinoo master when the system comes up.
- ❑ **Stacheldraht** uses handlers on compromised hosts to receive encrypted commands from the attacker.

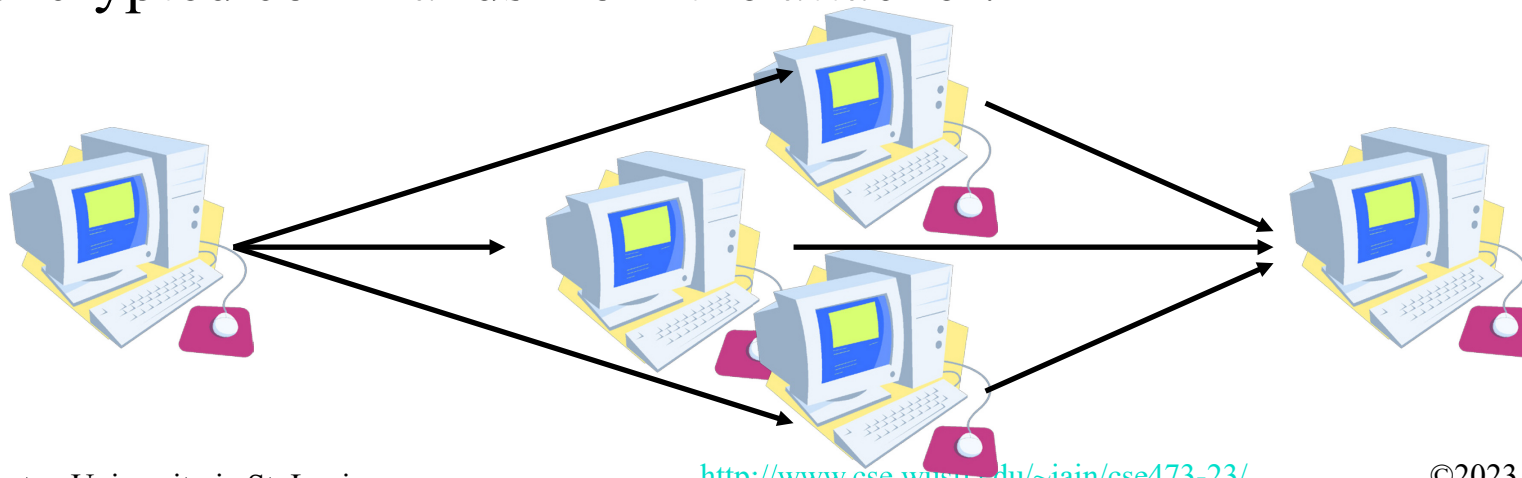

## Student Questions

- ❑ How does the Stacheldraht attack differ from TFN and Trinoo?  
*Similar but different programs.*

# History of Internet

- ❑ 1961: Kleinrock developed queueing theory. Showed effectiveness of packet-switching
- ❑ 1964: Baran's report on packet-switching in military nets
- ❑ 1967: ARPAnet conceived by Advanced Research Projects Agency
- ❑ 1969: First ARPAnet node operational  
First Request for Comment (RFC)

[www.ietf.org](http://www.ietf.org)

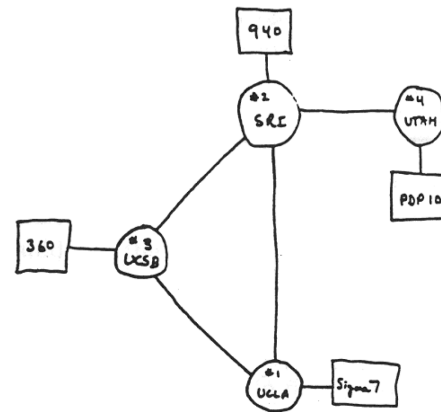

THE ARPA NETWORK

## Student Questions

# History of Internet (Cont)

- ❑ Early 1990s: HTML, HTTP: Berners-Lee
- ❑ 1994: Mosaic, later Netscape
- ❑ 2007:
  - ~500 million hosts
  - Voice, Video over IP
  - P2P applications: BitTorrent (file sharing), Skype (VoIP), PPLive (video)
  - Video applications: YouTube, gaming
  - Wireless, Mobility

## Student Questions

- ❑ It seems like the internet is Point to Point. Is this true?

*No. In some places, it is broadcast, e.g., in Wi-Fi.*

---

# Key Concepts

- ❑ **Internet Protocol (IP):** Protocol
- ❑ **Address:** All systems have an IP address, for example, 125.36.47.23
- ❑ **Name:** All systems have a human-readable name, e.g., scorpio.cec.wustl.edu, ibm.com.
- ❑ Technically called **DNS (domain name systems)** name. Details will be introduced later.
- ❑ **IETF:** Internet Engineering Task Force. Make standards for the Internet. IETF.org
- ❑ **RFC:** Request for comments. Documents that describe Internet protocols.

## Student Questions

- ❑ Are IP addresses and names identical?  
*Not identical. They are related.*
  - ❑ What is the difference between IPv4 and IPv6?  
*Version 4 and Version 6.*
  - ❑ How do you convert from DNS to IP?  
*See Chapter 2.*
- 
- ❑ What exactly is the difference between a name and a domain name?  
*The domain name is a standardized format of names for networking nodes.*
  - ❑ Are we sticking to IPv4 for this course, or are we going to discuss IPv6 as well?  
*Mostly IPv4. IPv6 briefly.*
  - ❑ Are IPv6 addresses also all 8-bit numbers?  
*128-bit*

# Summary

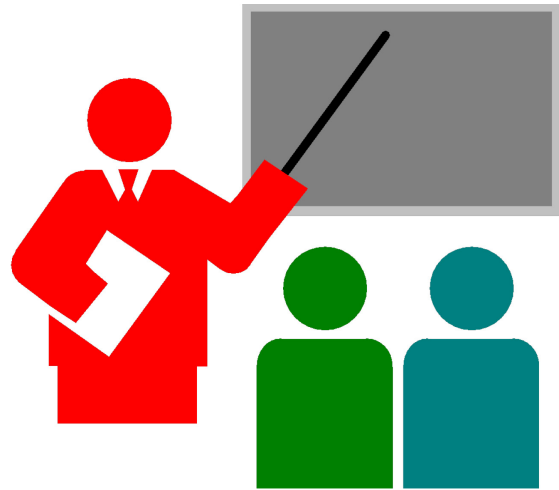

1. The most common medium is **UTP**, wireless, fiber
2. **The Internet** is a network of networks
3. Enterprise, **access**, and **core** networks
4. Performance Measures: **Delay**, **Throughput**, **Loss** Rate
5. Protocol Layers: **ISO** and **TCP/IP** reference models

Ref: Read entire Chapter 1 and try R1-R28 8<sup>th</sup> Edition.

## Student Questions

- ❑ Is homework due before class or after class, or do we have some time?

*Homework is due at 1 PM on the due date.*

- ❑ Why is ipv6 so scarcely used?

*Old habits die hard. Too much deployed equipment.*

- 
- ❑ Are the Enterprise networks the Stub networks we discussed in the previous lecture?

*Yes*



# Lab 1: Internet and Wireshark

[6 points]

1. Find the IP address of your computer (ipconfig, ifconfig)
2. Find the IP address of [www.wustl.edu](http://www.wustl.edu) (ping)
3. Measure the delay from your computer to [www.wustl.edu](http://www.wustl.edu) (ping or tracert)

For all cases, submit the screen snapshot showing the command used and the output. (Use Alt-Print-screen to capture a window to the clipboard and then paste it to word)

## Student Questions

- How do you measure the delay from a computer to a website? What is tracert?  
*Type these commands in a Windows command prompt box and see what happens. E.g., try 'tracert www.wustl.edu'*  
*They work similarly in Mac and Linux.*
- What do you mean by the internet address of google there? Do you mean the IP address?  
*Yes.*

- 
- Is it all right if we use a snipping or other screenshot tools, or do you need a full screenshot?

*Snipping tools are OK.*

- How is the number of hops determined by tracert?

*By counting the number of routers on the path.*

# Lab 1 (Cont)

## 4. Download Wireshark,

<https://www.wireshark.org/download.html>

- Install it on your laptop.
- If you are using a windows computer, you will also need npcap (Packet Capture Tool) from nmap.org.
- Start Wireshark and start logging.
- **Tracert** to [www.google.com](http://www.google.com)
- Stop logging. Capture the current screen and submit. Do not worry about the part of the trace that is no longer on the screen.
- Q1: List 3 protocols that you see in the packet trace.
- Q2: What is the internet address of [www.google.com](http://www.google.com) from the trace?

Please see Slide 1-63 for additional hints on this lab

## Student Questions

- ❑ I'm confused about what we should do with Wireshark. I downloaded the application but have no idea what to do with it. Is it possible for you to go over that a little bit more?

*First, become familiar with various functions. Then start logging. Go to another window and start Tracert. Come back and stop logging. Look at the log.*

# Reading List

- Read Chapter 2 of the textbook for the next class.

## Student Questions

# Acronyms

❑ APDU	Application Packet Data Unit
❑ ARPAnet	Advanced Research Project Agency Network
❑ ASCII	American Standard Code for Information Interchange
❑ AT&T	American Telephone and Telegraph
❑ CBR	Constant Bit Rate
❑ CIA	Confidentiality, Integrity, Access
❑ DNS	Domain Name Service
❑ DoS	Denial of Service
❑ DPDU	Datalink Packet Data Unit
❑ DSDU	Datalink Service Data Unit
❑ DSL	Digital Subscriber Line
❑ FDM	Frequency Division Multiplexing
❑ FTP	File Transfer Protocol
❑ FTTH	Fiber to the host
❑ GHz	Giga Hertz
❑ HFC	Hybrid Fiber Coax

## Student Questions

- ❖ Do we need to remember all Acronyms? Even if some are not mentioned in the slide at all?

*At least those that are mentioned in the slides or in the book.*

# Acronyms (Cont)

- ❑ HTML Hyper-Text Markup Language
- ❑ HTTP Hyper-Text Transfer Protocol
- ❑ IEEE Institution of Electrical and Electronics Engineers
- ❑ IETF Internet Engineering Task Force
- ❑ IP Internet Protocol
- ❑ ISO International Standards Organization
- ❑ ISP Internet Service Provider
- ❑ kHz Kilo Hertz
- ❑ LAN Local Area Network
- ❑ LTE Long Term Evolution
- ❑ MAN Metropolitan Area Network
- ❑ MHz Mega Hertz
- ❑ NPDU Network Protocol Data Unit
- ❑ NSDU Network Service Data Unit
- ❑ OSI Open System Interconnect
- ❑ PC Personal Computer

## Student Questions

# Acronyms (Cont)

- ❑ PDU Protocol Data Unit
- ❑ PhSDU Physical Service Data Unit
- ❑ PON Passive Optical Network
- ❑ PPDU PHY protocol data unit
- ❑ PSDU PHY Service data unit
- ❑ RFC Request for Comments
- ❑ SAPs Service Access Points
- ❑ SDU Service Data Units
- ❑ SPDU Session Protocol Data Unit
- ❑ SSDU Session Service Data Unit
- ❑ STP Shielded Twisted Pair
- ❑ TCP Transmission Control Protocol
- ❑ TDM Time Division Multiplexing
- ❑ TFN Tribe Flood Network
- ❑ TP Twisted Pair
- ❑ TSDU Transport Service Data Unit

## Student Questions

# Acronyms (Cont)

- ❑ TV            Television
- ❑ UDP        Universal Data Protocol
- ❑ UTP        Unshielded Twisted Pair
- ❑ VoIP       Voice over IP
- ❑ WAN        Wide Area Network
- ❑ WiFi       Wireless Fidelity

## Student Questions

# Scan This to Download These Slides



Raj Jain

<http://rajjain.com>

[http://www.cse.wustl.edu/~jain/cse473-23/i\\_1cni.htm](http://www.cse.wustl.edu/~jain/cse473-23/i_1cni.htm)

## Student Questions

- Do we still use broadcast technology in today's world, or is it directed?  
*Wireless is mostly broadcast.*
- For the circuit, does it mean if I want to connect to Amazon, Amazon has to be online first, then we can build the connection and talk?

*Yes.*

- Which types of networks are more common, and how can they be identified?

*Please wait till you learn about different network technologies.*

- 
- Is it better to watch the video first and then the teaching material, or is it better to watch the teaching material first and then watch the video?

*Watch the video and keep the slides to write down the questions for later reference.*



# Scan This to Download These Slides



Raj Jain

<http://rajjain.com>

[http://www.cse.wustl.edu/~jain/cse473-23/i\\_1cni.htm](http://www.cse.wustl.edu/~jain/cse473-23/i_1cni.htm)

## Student Questions

- Will OFDM be introduced in this course?

*Yes, in the wireless Chapter 7.*

# Related Modules



CSE 567: The Art of Computer Systems Performance Analysis  
[https://www.youtube.com/playlist?list=PLjGG94etKypJEKjNAa1n\\_1X0bWWNyZcof](https://www.youtube.com/playlist?list=PLjGG94etKypJEKjNAa1n_1X0bWWNyZcof)

CSE473S: Introduction to Computer Networks (Fall 2011),

[https://www.youtube.com/playlist?list=PLjGG94etKypJWOSPMh8Azcg5e\\_10TiDw](https://www.youtube.com/playlist?list=PLjGG94etKypJWOSPMh8Azcg5e_10TiDw)



CSE 570: Recent Advances in Networking (Spring 2013)

<https://www.youtube.com/playlist?list=PLjGG94etKypLHyBN8mOgwJLHD2FFIMGq5>

CSE571S: Network Security (Spring 2011),

<https://www.youtube.com/playlist?list=PLjGG94etKypKvzfVtutHcPFJXumyyg93u>



Video Podcasts of Prof. Raj Jain's Lectures,

<https://www.youtube.com/channel/UCN4-5wzNP9-ruOzQMs-8NUw>

## Student Questions

# Lab 1: Hints

- ❑ The HTTP traffic may not show in Wireshark if:
  1. You may not have installed npcap
  2. You may not be using Tracert. Do not use HTTP for this lab.
- 2. The websites you are doing your test on use HTTPS (TLS). In this case, Wireshark will identify the protocol as a TLS packet, not an HTTP packet.
- 3. If you are using Chrome, Edge, or any browser based on Chromium engine, the traffic when accessing google.com will show as QUIC because Google uses QUIC for their websites. Also, this is valid for other websites that use QUIC.
- ❑ If you want to see the content of A TLS packet, follow this guide:  
<https://wiki.wireshark.org/TLS#:~:text=Step-by-step%20instructions%20to%20decrypt%20TLS%20traffic%20from%20Chrome,from%20step%202%20is%20created.%20More%20items...%20>

## Student Questions