

# The Network Layer: Data Plane

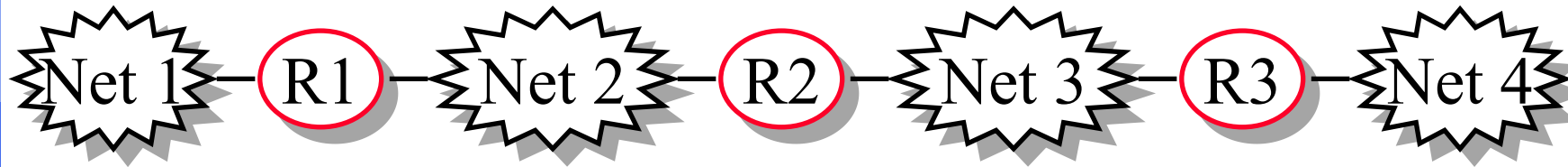

**Raj Jain**

Washington University in Saint Louis

Saint Louis, MO 63130

Jain@wustl.edu

Audio/Video recordings of this lecture are available on-line at:

<http://www.cse.wustl.edu/~jain/cse473-21/>

**Student Questions**



1. Network Layer Basics
2. What's inside a router?
3. Forwarding Protocols: IPv4, DHCP, NAT, IPv6
4. Software Defined Networking

**Note:** This class lecture is based on Chapter 4 of the textbook (Kurose and Ross) and the figures provided by the authors.

## Student Questions



# Network Layer Basics

1. Forwarding and Routing
2. Connection Oriented Networks: ATM Networks
3. Classes of Service
4. Router Components
5. Packet Queuing and Dropping

## Student Questions

# Forwarding and Routing

- ❑ **Forwarding:** Input link to output link via Address prefix lookup in a table.
- ❑ **Routing:** Making the Address lookup table
- ❑ **Longest Prefix Match**

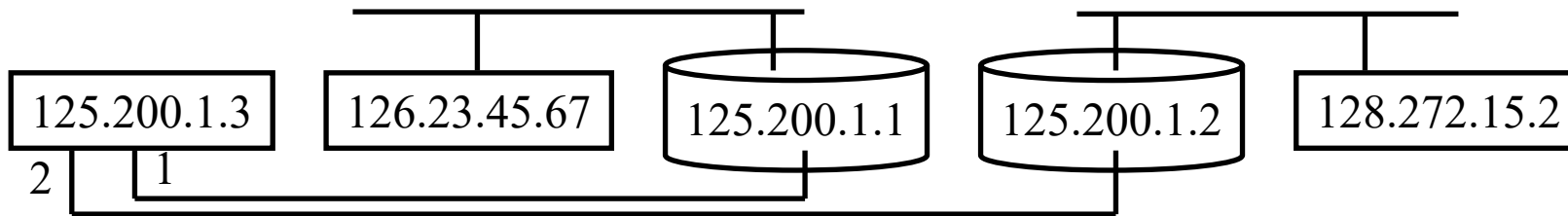

Prefix	Next Router	Interface
126.23.45.67/32	125.200.1.1	1
128.272.15/24	125.200.1.2	2
128.272/16	125.200.1.1	1

## Student Questions

Ref: **Optional Homework: R3** in the textbook

Washington University in St. Louis

<http://www.cse.wustl.edu/~jain/cse473-21/>

©2021 Raj Jain

# Network Service Models

- ❑ Guaranteed Delivery: No packets lost
- ❑ Bounded delay: Maximum delay
- ❑ In-Order packet delivery: Some packets may be missing
- ❑ Guaranteed minimal throughput
- ❑ Guaranteed maximum jitter: Delay variation
- ❑ Security Services (optional in most networks)
- ❑ ATM offered most of these
- ❑ IP offers none of these  $\Rightarrow$  Best effort service (Security is optional)

Optional Homework: R4, R5 in the textbook

## Student Questions

# What's Inside a Router?

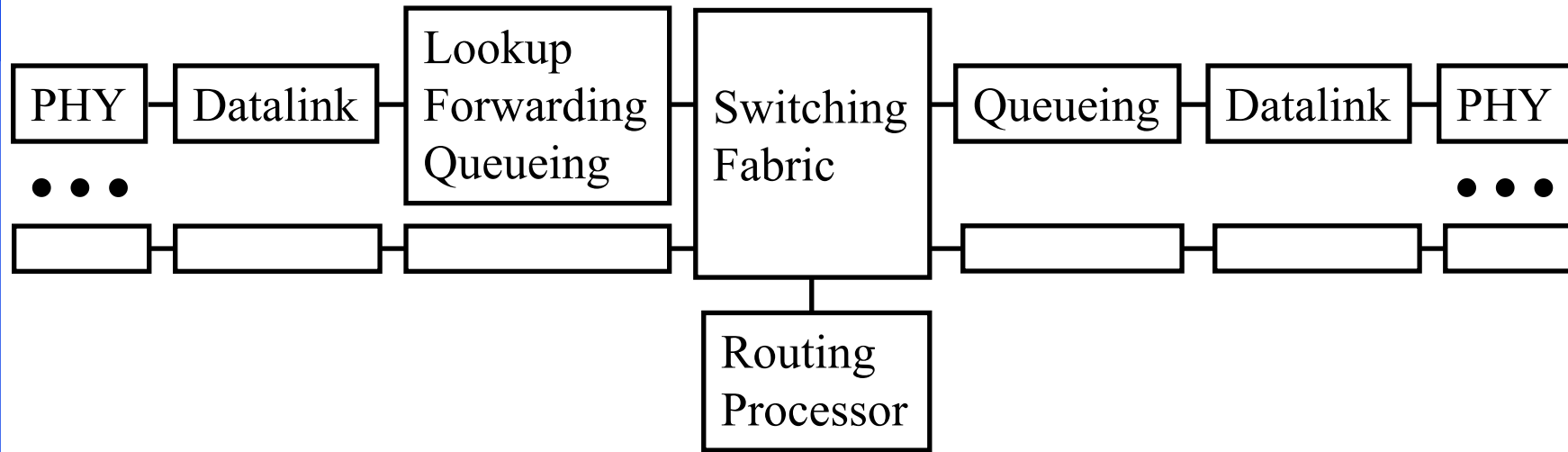

- ❑ **Input Ports:** receive packets, lookup address, queue  
Use **Content Addressable Memories** (CAMs) and caching
- ❑ **Switch Fabric:** Send from input port to output port
- ❑ **Output Ports:** Queuing, transmit packets

## Student Questions

# Types of Switching Fabrics

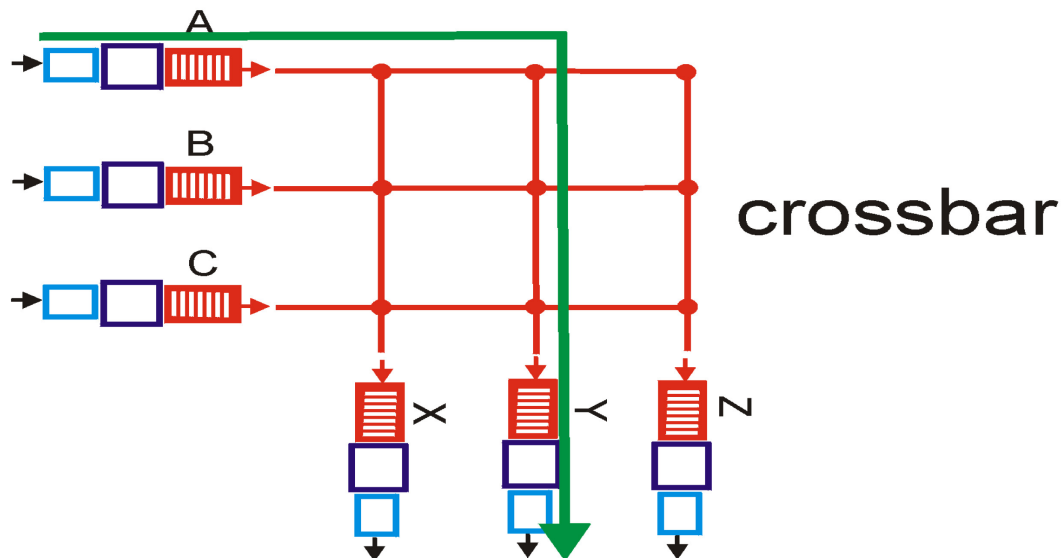
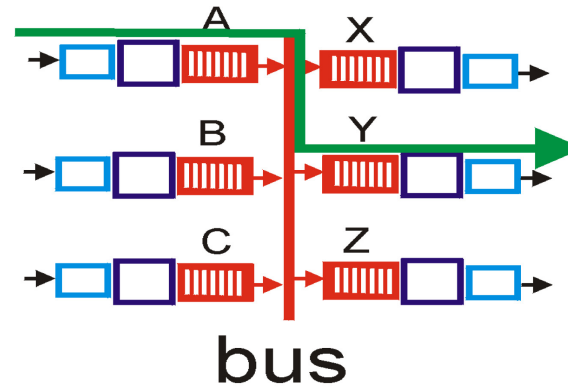
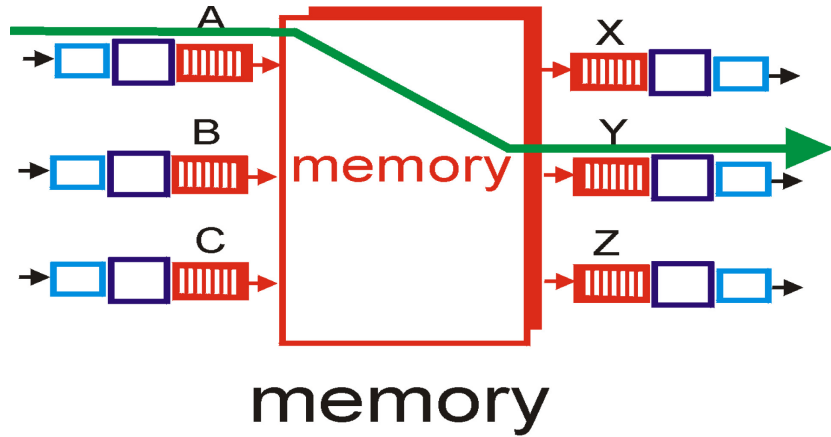

## Student Questions

# Where Does Queuing Occur?

- ❑ If switching fabric is slow, packets wait on the input port.
- ❑ If switching fabric is fast, packets wait for output port  
⇒ Queueing (Scheduling) and drop policies
- ❑ Queueing: First Come First Served (FCFS),  
Weighted Fair Queueing

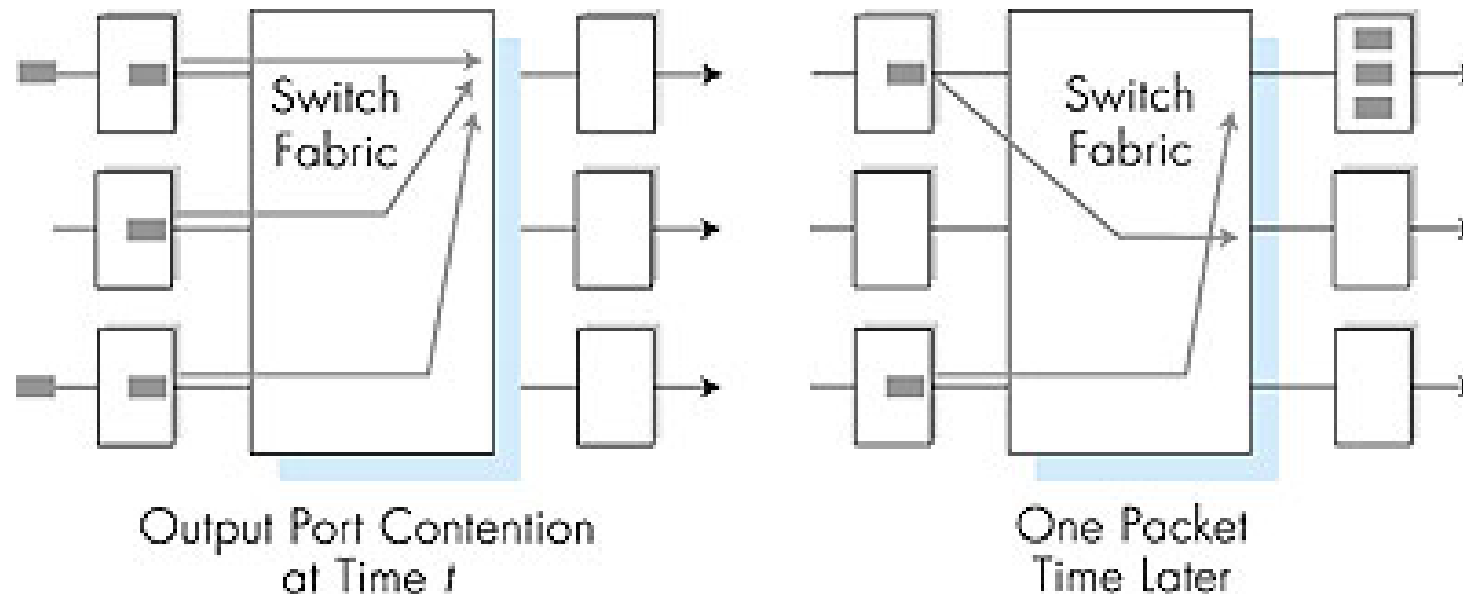

## Student Questions



# Ideal Buffering

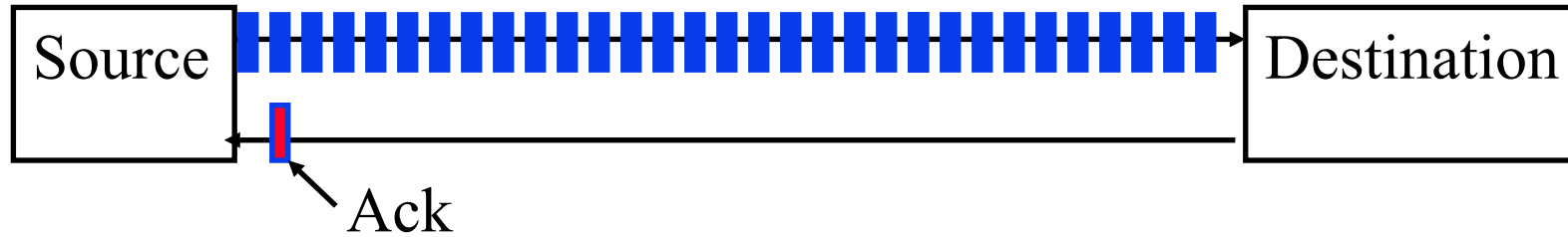

- ❑ Flow Control Buffering =  $RTT * \text{Transmission Rate}$
- ❑ Buffer =  $RTT * \text{Transmission Rate} / \sqrt{(\# \text{ of TCP flows})}$

## Student Questions

# Packet Dropping Policies

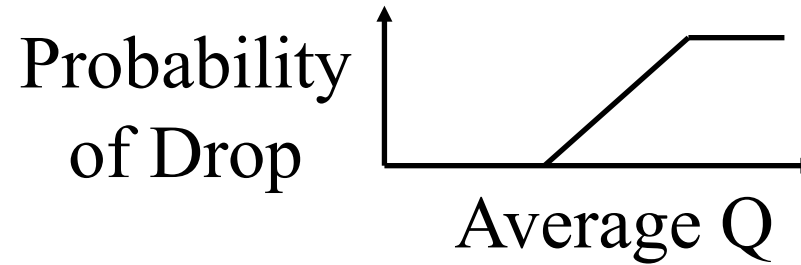
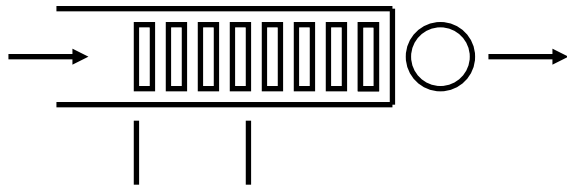

- ❑ **Drop-Tail:** Drop the arriving packet
  - ❑ **Random Early Drop (RED):** Drop arriving packets even before the queue is full
    - Routers measure average queue and drop incoming packet with certain probability
- ⇒ **Active Queue Management (AQM)**

## Student Questions

# Head-of-Line Blocking

- Packet at the head of the queue is waiting  
⇒ Other packets can not be forwarded even if they are going to other destination

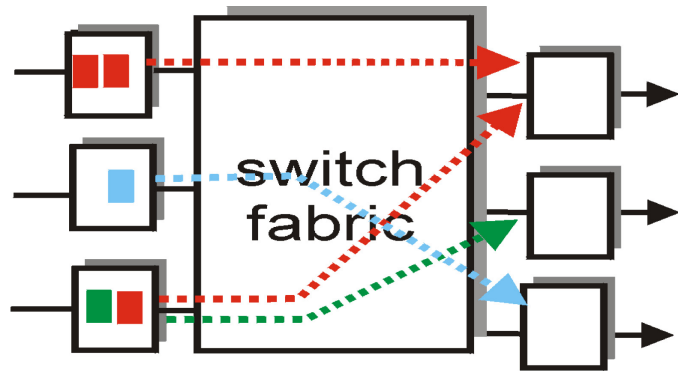

output port contention  
at time t - only one red  
packet can be transferred

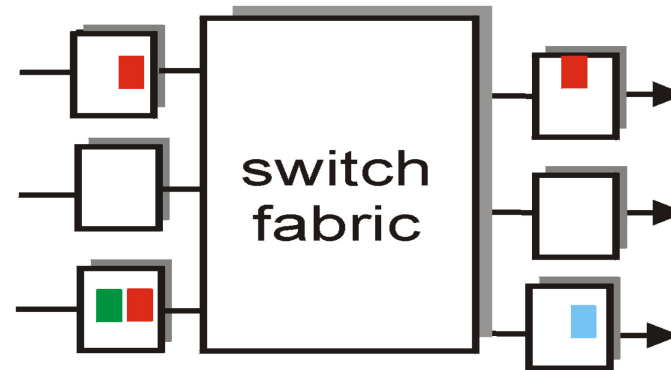

green packet  
experiences HOL blocking

## Student Questions

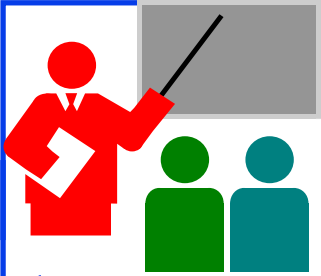

## Network Layer Basics: Review

1. Forwarding uses routing table to find output port for datagrams using **longest prefix match**. Routing protocols make the table.
2. IP provides only **best effort** service (KISS).
3. Routers consist of input/output ports, **switching fabric**, and processors.
4. Datagrams may be dropped even if the queues are not full (**Random early drop**).
5. Queueing at input may result in **head of line blocking**.

### Student Questions

Ref: Read Sections 4.1, 4.2, full, Page 305-329 of the textbook. Try R1 through R16

Washington University in St. Louis

<http://www.cse.wustl.edu/~jain/cse473-21/>

©2021 Raj Jain



# Forwarding Protocols

1. IPv4 Datagram Format
2. IP Fragmentation and Reassembly
3. IP Addressing
4. Network Address Translation (NAT)
5. Universal Plug and Play
6. Dynamic Host Control Protocol (DHCP)
7. IPv6

## Student Questions

# IP Datagram Format



4b      4b      8b      16b      16b



1b      1b      1b      13b      8b      8b

Flags

1=ICMP  
6=TCP  
17=UDP



16b      32b      32b      Variable      Variable      Variable

Multiple of 4B

## Student Questions

# IP Fragmentation Fields

- ❑ Header length: in units of 32-bit words
- ❑ Data Unit Identifier (ID)
  - Sending host puts an identification number in each datagram
- ❑ Total length: Length of user data plus header in bytes
- ❑ Fragment Offset - Position of fragment in original datagram
  - ❑ In multiples of 8 byte blocks
- ❑ *More fragments* flag
  - ❑ Indicates that this is not the last fragment
- ❑ Datagrams can be fragmented/refragmented at any router
- ❑ Datagrams are reassembled only at the destination host

## Student Questions





# Homework 4A: Fragmentation

- [8 points] Consider sending a 2400-byte datagram into a link that has an MTU of 720 bytes. Suppose the original datagram is stamped with the identification number 422. How many fragments are generated? What are the values in the various fields in the IP datagram(s) generated related to fragmentation?

## Student Questions

# IP Address Classes

- |      |         |       |
|------|---------|-------|
| 0    | Network | Local |
| 1    | 7       | 24    |
| bits |         |       |
  
- |      |         |       |
|------|---------|-------|
| 10   | Network | Local |
| 2    | 14      | 16    |
| bits |         |       |
  
- |      |         |       |
|------|---------|-------|
| 110  | Network | Local |
| 3    | 21      | 8     |
| bits |         |       |
  
- |      |                        |
|------|------------------------|
| 1110 | Host Group (Multicast) |
| 4    | 28                     |
| bits |                        |
  
- |       |            |
|-------|------------|
| 11110 | Future use |
| 5     | 27         |
| bits  |            |
  
- Local = Subnet<sup>5</sup> + Host<sup>27</sup> (Variable length)

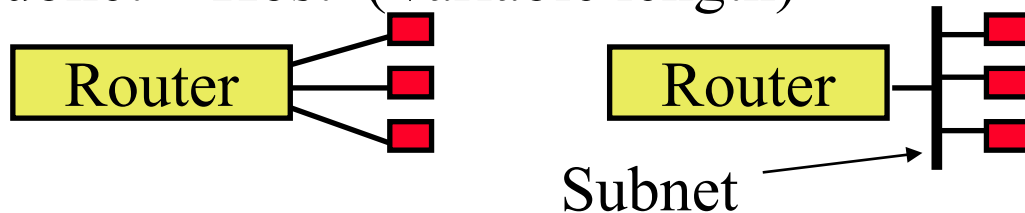

## Student Questions

# IP Addressing

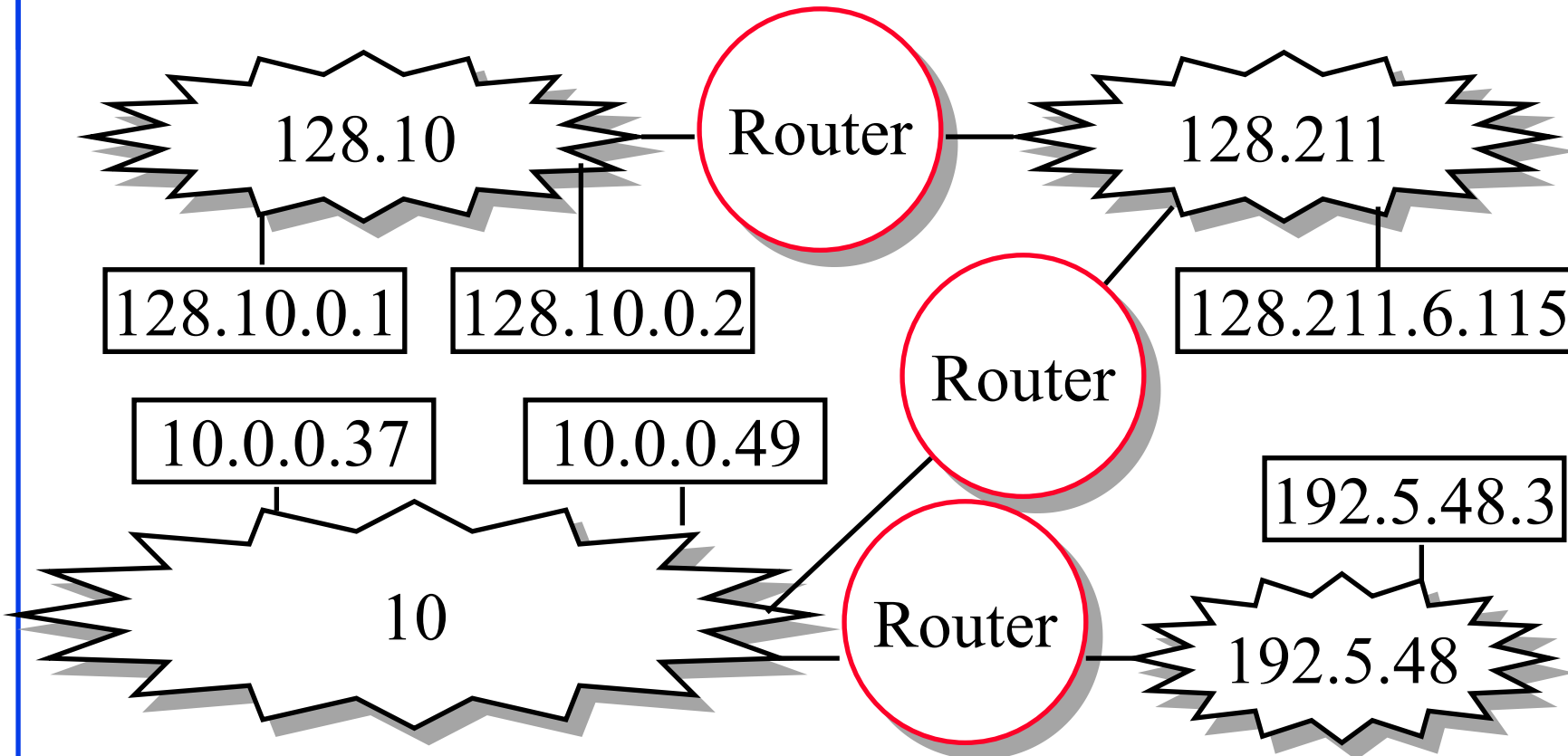

- ❑ All IP hosts have a 32-bit address. 128.10.0.1  
= 1000 0000 0000 1010 0000 0000 0000 0001
- ❑ All hosts on a network have the same network prefix

## Student Questions

# Subnetting

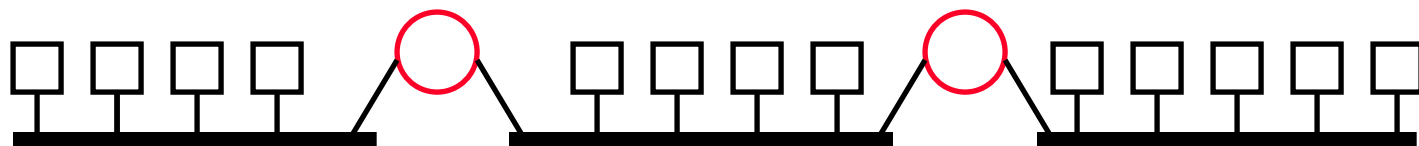

- ❑ All hosts on a subnetwork have the same prefix.  
Position of the prefix is indicated by a “subnet mask”
- ❑ Example: First 23 bits = subnet  
Address: 10010100 10101000 00010000 11110001  
Mask: 11111111 11111111 11111110 00000000  
.AND. 10010100 10101000 00010000 00000000

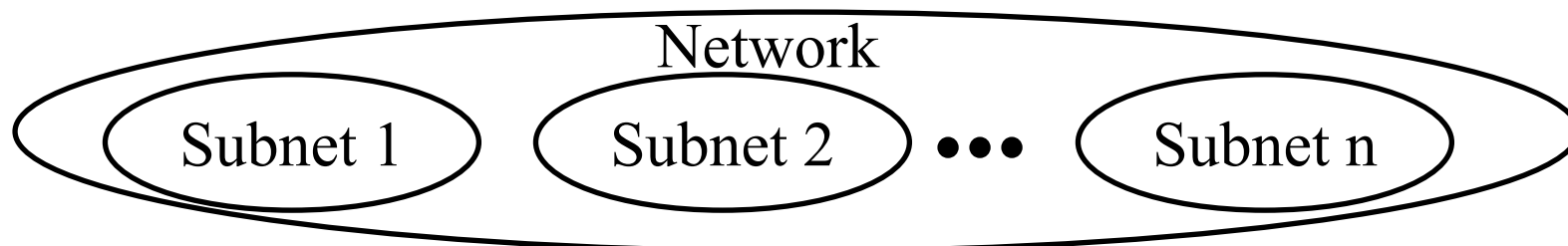

## Student Questions

# IP addressing: CIDR

## □ CIDR: Classless InterDomain Routing

- Subnet portion of address of arbitrary length
- Address format: a.b.c.d/x, where x is # bits in subnet portion of address
- All 1's in the host part is used for subnet broadcast
- All 0's in the host part was meant as “subnet address” but not really used for anything. Some implementation allow it to be used as host address. Some don't. Better to avoid it.



11001000 00010111 00010000 00000000

200.23.16.0/23

## Student Questions

# Homework 4B: Subnets

- [22 points] Consider a router that interconnects 3 subnets: Subnet 1, Subnet 2, and Subnet 3. Suppose all of the interfaces in each of these three subnets are required to have the prefix 223.1.17/24. Also suppose that Subnet 1 is required to support up to 61 interfaces, Subnet 2 is to support up to 96 interfaces, and Subnet 3 is to support up to 16 interfaces. Provide three network address prefixes (of the form a.b.c.d/x) that satisfy these constraints. **Use adjacent allocations.** For each subnet, also list the subnet mask to be used in the hosts.

## Student Questions

# Forwarding an IP Datagram

- ❑ Delivers **datagrams** to destination network (subnet)
- ❑ Routers maintain a “routing table” of “next hops”
- ❑ Next Hop field does not appear in the datagram

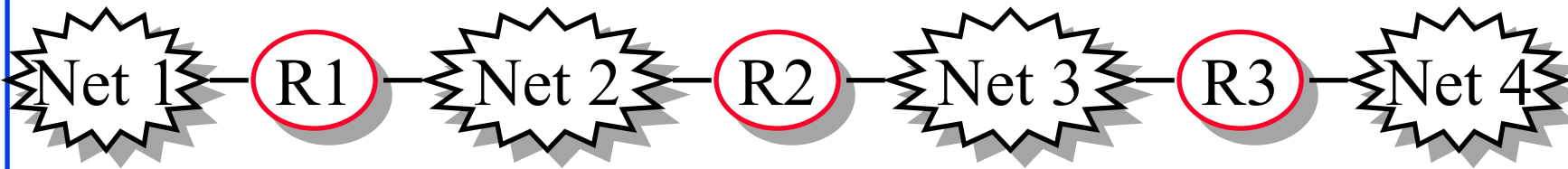

Table at R2:

Destination      Next Hop

Net 1	Forward to R1
Net 2	Deliver Direct
Net 3	Deliver Direct
Net 4	Forward to R3

## Student Questions

# Route Aggregation

- ❑ Can combine two or more prefixes into a shorter prefix
- ❑ ISPs-R-Us has a more specific route to organization 1

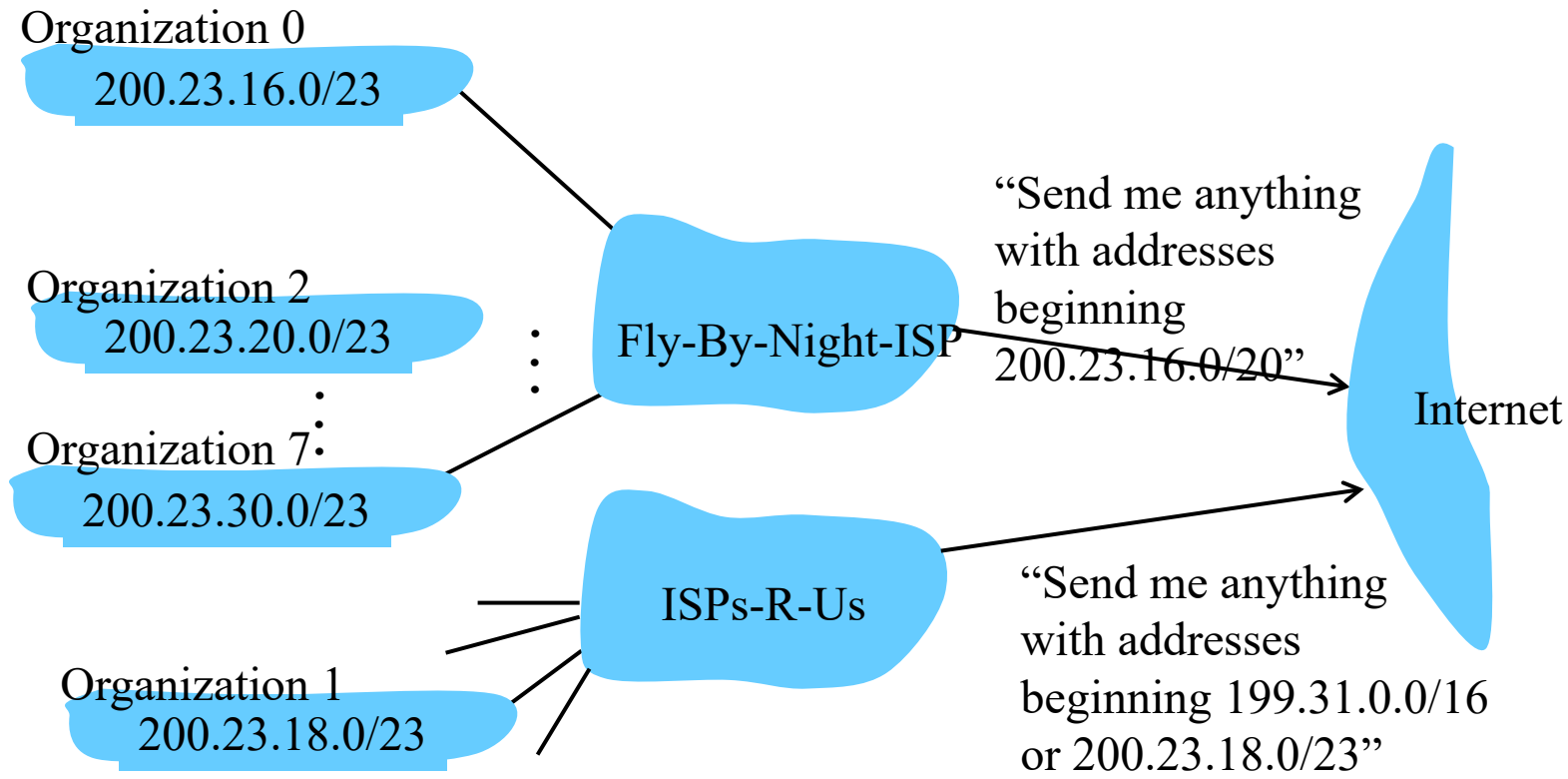

## Student Questions

Ref: Section 4.3.3. Try R27, R28

Washington University in St. Louis

<http://www.cse.wustl.edu/~jain/cse473-21/>

©2021 Raj Jain



# “Route Print” Command in Windows

MAC: netstat -rn

---

---

## Interface List

0x1 ..... MS TCP Loopback interface  
0x2 ...00 16 eb 05 af c0 ..... Intel(R) WiFi Link 5350 - Packet Scheduler Miniport  
0x3 ...00 1f 16 15 7c 41 ..... Intel(R) 82567LM Gigabit Network Connection - Packet Scheduler Miniport  
0x40005 ...00 05 9a 3c 78 00 ..... Cisco Systems VPN Adapter - Packet Scheduler Miniport

---

---

## Active Routes:

Network Destination	Netmask	Gateway	Interface	Metric
0.0.0.0	0.0.0.0	192.168.0.1	192.168.0.108	10
0.0.0.0	0.0.0.0	192.168.0.1	192.168.0.106	10
127.0.0.0	255.0.0.0	127.0.0.1	127.0.0.1	1
169.254.0.0	255.255.0.0	192.168.0.106	192.168.0.106	20
192.168.0.0	255.255.255.0	192.168.0.106	192.168.0.106	10
192.168.0.0	255.255.255.0	192.168.0.108	192.168.0.108	10
192.168.0.106	255.255.255.255	127.0.0.1	127.0.0.1	10
192.168.0.108	255.255.255.255	127.0.0.1	127.0.0.1	10
192.168.0.255	255.255.255.255	192.168.0.106	192.168.0.106	10
192.168.0.255	255.255.255.255	192.168.0.108	192.168.0.108	10
224.0.0.0	240.0.0.0	192.168.0.106	192.168.0.106	10
224.0.0.0	240.0.0.0	192.168.0.108	192.168.0.108	10
255.255.255.255	255.255.255.255	192.168.0.106	192.168.0.106	1
255.255.255.255	255.255.255.255	192.168.0.106	40005	1
255.255.255.255	255.255.255.255	192.168.0.108	192.168.0.108	1

Default Gateway: 192.168.0.1

---

---

## Persistent Routes:

None

Note: 127.0.0.1 = Local Host, 224.x.y.z = Multicast on local LAN

Adr & mask = Dest

⇒ Match

Longest Prefix match  
is used

Metric: Lower is better

## Student Questions

# Lab 4A: Routing Table

- ❑ [8 Points] Use “Route Help” in Windows (or man route in MAC) to learn the route command
- ❑ Ping [www.google.com](http://www.google.com) to find its address
- ❑ Make sure that you have two active interfaces preferably connected to different routers. For example, create a 2<sup>nd</sup> interface by connecting a smart phone hot spot via USB. Or by connecting to a router in our lab during TA hours
- ❑ Print route table
- ❑ Trace route to [www.google.com](http://www.google.com) using tracert
- ❑ Modify the routing table so that the other interface will be used.
- ❑ Note the command you used to modify the routing table
- ❑ Print the new routing table
- ❑ Trace route to the same numeric address for [www.google.com](http://www.google.com) as before . Submit underlined items.

## Student Questions

# Lab 4A Hints

- ❑ A host with two interfaces going to the same router:

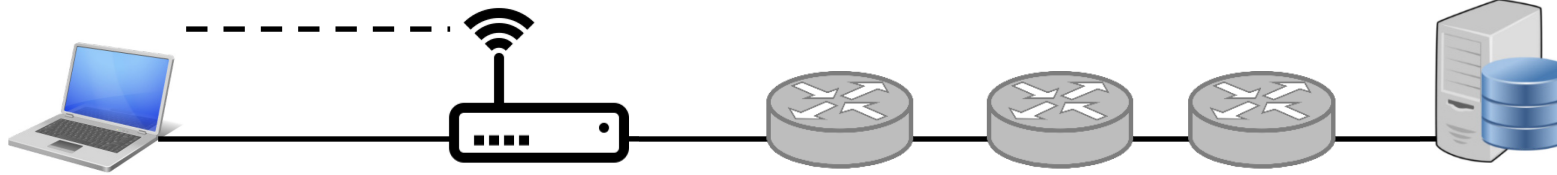

- ❑ Trace route result will not change even if you change the interface.

```
IPv4 Route Table
-----
Active Routes:
Network Destination    Netmask          Gateway          Interface        Metric
-----
0.0.0.0                0.0.0.0         192.168.0.1     192.168.0.152   55
0.0.0.0                0.0.0.0         192.168.0.1     192.168.0.151   25
```

## Student Questions

# Lab 4A Hints (Cont)

- ❑ If you have two routers, you can see the effect in trace route. One way to get two routers is to use your cell phone hot spot:

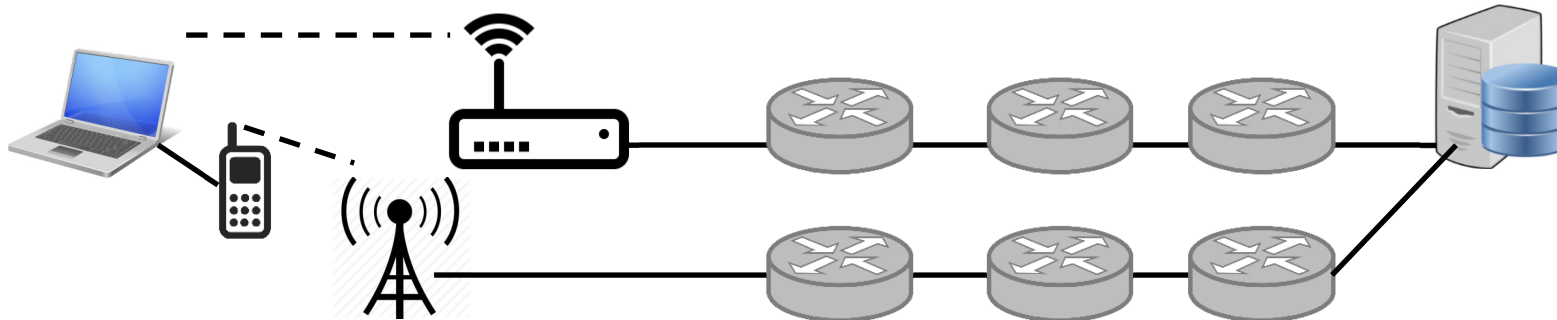

```
IPv4 Route Table
=====
Active Routes:
Network Destination    Netmask          Gateway          Interface        Metric
-----
0.0.0.0                0.0.0.0         192.168.0.1     192.168.0.151   25
0.0.0.0                0.0.0.0         172.20.10.1     172.20.10.2    35
```

- ❑ WiFi on phone should be disabled to ensure that it does not forward the traffic to the same home router.

## Student Questions

# Lab 4A Hints (Cont)

- Another way to get two routers is to use another router. We have placed an extra router in our lab.

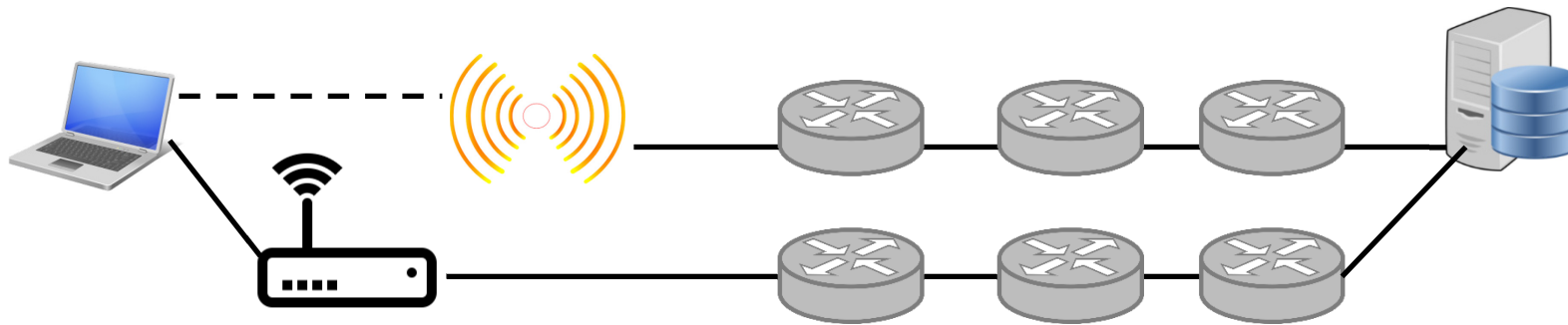

```
IPv4 Route Table
=====
Active Routes:
Network Destination    Netmask          Gateway          Interface        Metric
-----
0.0.0.0                0.0.0.0         192.168.0.1     192.168.0.151   25
0.0.0.0                0.0.0.0         172.20.10.1     172.20.10.2    35
```

## Student Questions

## Lab 4A Hints (Cont)

- ❑ [WWW.google.com](http://www.google.com) may have different IP addresses on different networks and so trace route to the same numeric address.
- ❑ WUSTL VPN rejects all traffic not going to WUSTL. So it can not be used as the 2<sup>nd</sup> interface.
- ❑ The new metric assigned by the route command may not be what you specified. So always check using route print.

### Student Questions

# Lab 4A Hints (Cont)

- A. Use “route help” to learn the route command
- ❑ **Windows:** route help
  - ❑ **Linux:** route help
  - ❑ **MAC:**
    - man netstat
    - man route
- B. Ping [www.google.com](http://www.google.com) to find its address
- ping [www.google.com](http://www.google.com)
- C. Print the new routing table
- ❑ **Windows:**
    - route print
  - ❑ **Linux:**
    - route
  - ❑ **MAC:**
    - netstat -nr
- D. Modify routing tables
- ❑ **Windows:**
    - route add/delete/change
  - ❑ **Linux:**
    - route add/del
  - ❑ **MAC:**
    - sudo route -nv add
- E. Verify using tracert
- ❑ **Windows:**
    - tracert
  - ❑ **Linux:**
    - traceroute
  - ❑ **MAC:**
    - traceroute

## Student Questions

# Private Addresses

- ❑ Any organization can use these inside their network  
Can't go on the internet. [RFC 1918]
- ❑ 10.0.0.0 - 10.255.255.255 (10/8 prefix)
- ❑ 172.16.0.0 - 172.31.255.255 (172.16/12 prefix)
- ❑ 192.168.0.0 - 192.168.255.255 (192.168/16 prefix)

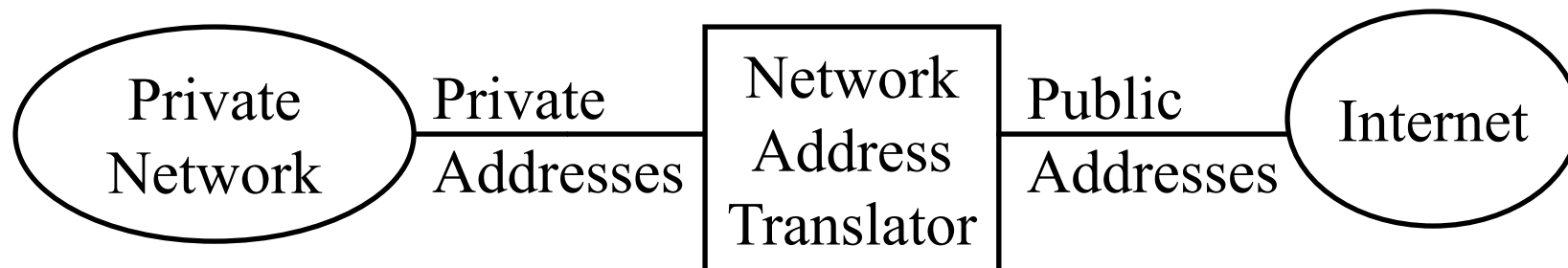

## Student Questions



# Network Address Translation (NAT)

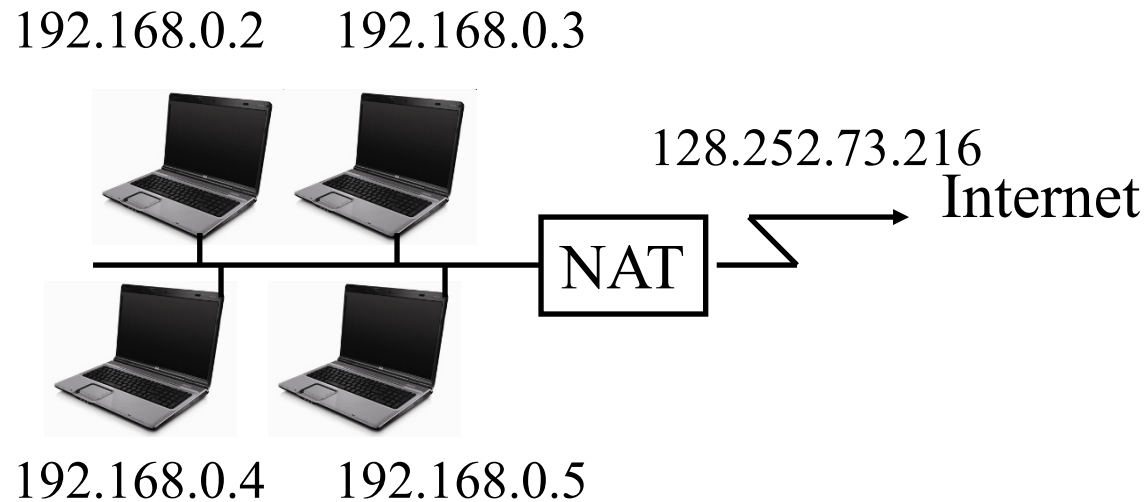

- ❑ Private IP addresses 192.168.x.x
- ❑ Can be used by anyone inside their networks
- ❑ Cannot be used on the public Internet
- ❑ NAT overwrites source addresses on all outgoing packets and overwrites destination addresses on all incoming packets
- ❑ Only outgoing connections are possible

## Student Questions

# Universal Plug and Play

- ❑ NAT needs to be manually programmed to forward external requests
- ❑ UPnP allows hosts to request port forwarding
- ❑ Both hosts and NAT should be UPnP aware
- ❑ Host requests forwarding all port xx messages to it
- ❑ NAT returns the public address and the port #.
- ❑ Host can then announce the address and port # outside
- ❑ Outside hosts can then reach the internal host (server)

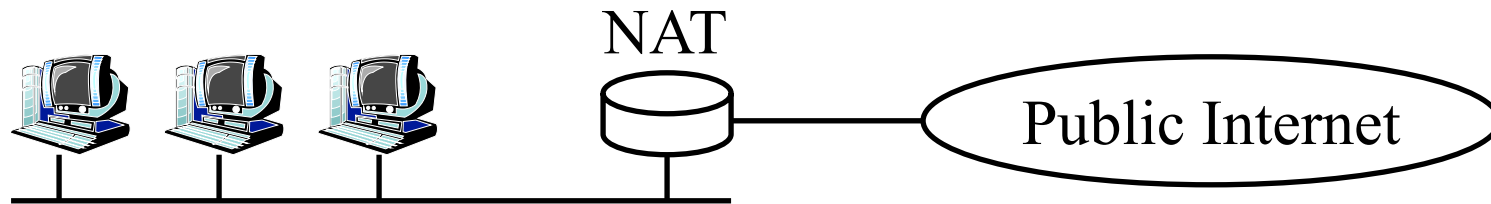

## Student Questions

# Homework 4C: NAT

- ❑ [4 points] Consider a home network of 3 computers connected to the Internet via a NAT router. Suppose the ISP assigns the router the address 23.34.112.235 and that the network address of the home network is 192.168.1/29.
- ❑ A. Assign addresses to all interfaces in the home network starting with the lowest possible address.
- ❑ B. What is the subnet mask for the home computers?
- ❑ C. Suppose each host has two ongoing TCP connections, all to port 80 at host 128.119.40.86. Provide the six corresponding entries in the NAT translation table. Both NAT and computers use source ports starting at 3000.

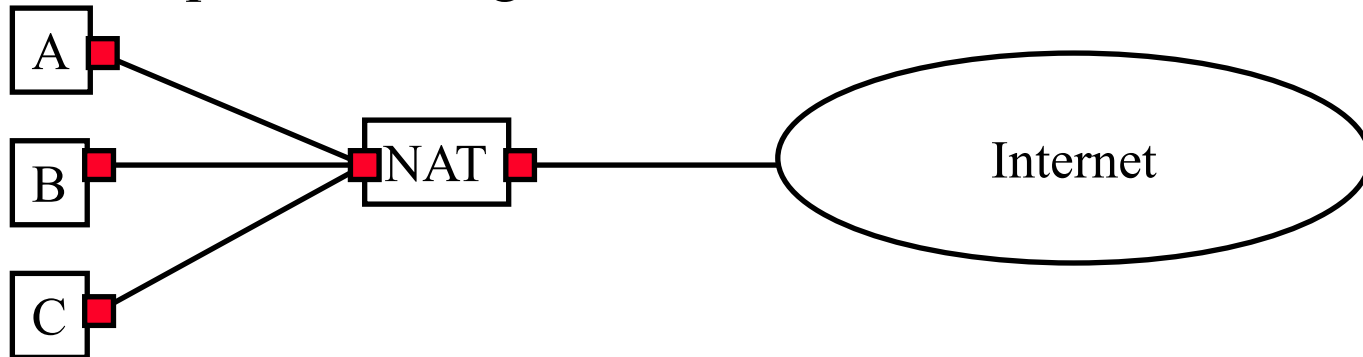

## Student Questions

# DHCP

- ❑ Dynamic Host Control Protocol
- ❑ Allows hosts to get an IP address automatically from a server
- ❑ Do not need to program each host manually
- ❑ Each allocation has a limited “lease” time
- ❑ Can reuse a limited number of addresses
- ❑ Hosts broadcast “Is there a DHCP Server Here?”  
Sent to 255.255.255.255
- ❑ DHCP servers respond

## Student Questions

# DHCP Example

DHCP server: 223.1.2.5

arriving  
client

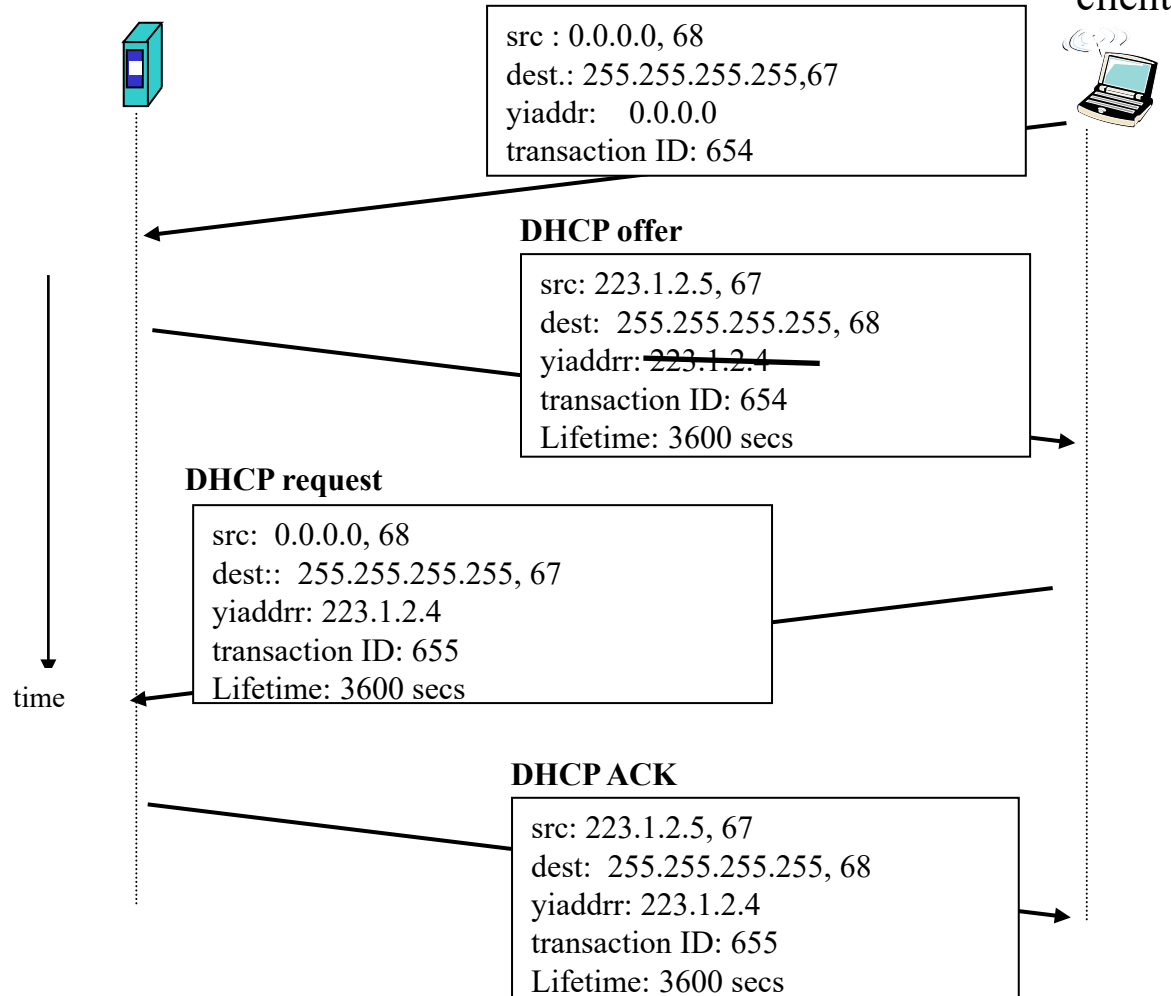

## Student Questions

# Lab 4B: DHCP

- ❑ [15 points] Download the Wireshark traces from <http://gaia.cs.umass.edu/wireshark-labs/wireshark-traces.zip>
- ❑ Open *dhcp-ethereal-trace-1* in Wireshark. Select **View → Expand All**. Answer the following questions:
  1. Examine Frame 2 marked DHCP.
    - A. What transport protocol and destination port # is used by DHCP?
    - B. What are the source and destination IP addresses for this frame and why?
    - C. What is the **Type-Length-Value** for the DHCP Discover option?
  2. Examine Frames 4, 5, 6 to find Type-Length-Value for:
    - A. DHCP Offer
    - B. DHCP Request
    - C. DHCP Ack

## Student Questions

## Lab 4B: DHCP (Cont)

### 3. Examine Frame 4:

- A. What IP address was assigned by the DHCP server?
- B. What IP address is this frame addressed to and why?
- C. What other information was provided by the DHCP server?
  1. Subnet Mask:
  2. Default Gateway:
  3. DNS1:
  4. DNS2:
  5. Domain Name:
  6. Lease Time:

### 4. Examine Frame 5 and find what preferred IP address was requested by the client?

### Student Questions

# IPv6

- ❑ Shortage of IPv4 addresses  $\Rightarrow$  Need larger addresses
- ❑ IPv6 was designed with 128-bit addresses
- ❑  $2^{128} = 3.4 \times 10^{38}$  addresses  
 $\Rightarrow 665 \times 10^{21}$  addresses per sq. m of earth surface
- ❑ If assigned at the rate of  $10^6/\mu\text{s}$ , it would take 20 years
- ❑ **Dot-Decimal:** 127.23.45.88
- ❑ **Colon-Hex:** FEDC:0000:0000:0000:3243:0000:0000:ABCD
  - Can skip leading zeros of each word
  - Can skip one sequence of zero words, e.g.,  
FEDC::3243:0000:0000:ABCD  
::3243:0000:0000:ABCD
  - Can leave the last 32 bits in dot-decimal, e.g., ::127.23.45.88
  - Can specify a prefix by /length, e.g., 2345:BA23:0007::/50

## Student Questions



# IPv6 Header

## □ IPv6:

Version (4b)	Traffic Class (8b)	Flow Label (20b)	
Payload Length (16b)		Next Header (8b)	Hop Limit (8b)
Source Address (128b)			
Destination Address (128b)			

## □ IPv4:

Version	IHL	Type of Service	Total Length
Identification		Flags	Fragment Offset
Time to Live	Protocol	Header Checksum	
Source Address			
Destination Address			
Options			Padding

## Student Questions

# IPv6 vs. IPv4

- ❑ 1995 vs. 1975
- ❑ IPv6 only twice the size of IPv4 header
- ❑ Only version number has same position and meaning as in IPv4
- ❑ Removed: header length, type of service, identification, flags, fragment offset, header checksum  $\Rightarrow$  No fragmentation
- ❑ Datagram length replaced by payload length
- ❑ Protocol type replaced by next header
- ❑ Time to live replaced by hop limit
- ❑ Added: Priority and flow label
- ❑ All fixed size fields.
- ❑ No optional fields. Replaced by extension headers.
- ❑ 8-bit hop limit = 255 hops max (Limits looping)
- ❑ Next Header = 6 (TCP), 17 (UDP)

## Student Questions

# IPv4 to IPv6 Transition

- ❑ **Dual Stack:** Each IPv6 router also implements IPv4  
IPv6 is used only if source host, destination host, and all routers on the path are IPv6 aware.
- ❑ **Tunneling:** The last IPv6 router puts the entire IPv6 datagram in a new IPv4 datagram addressed to the next IPv6 router  
= **Encapsulation**

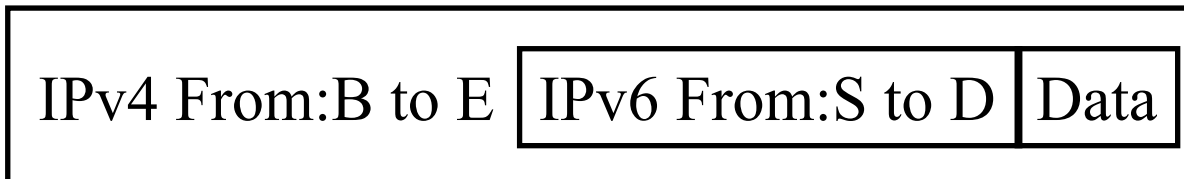
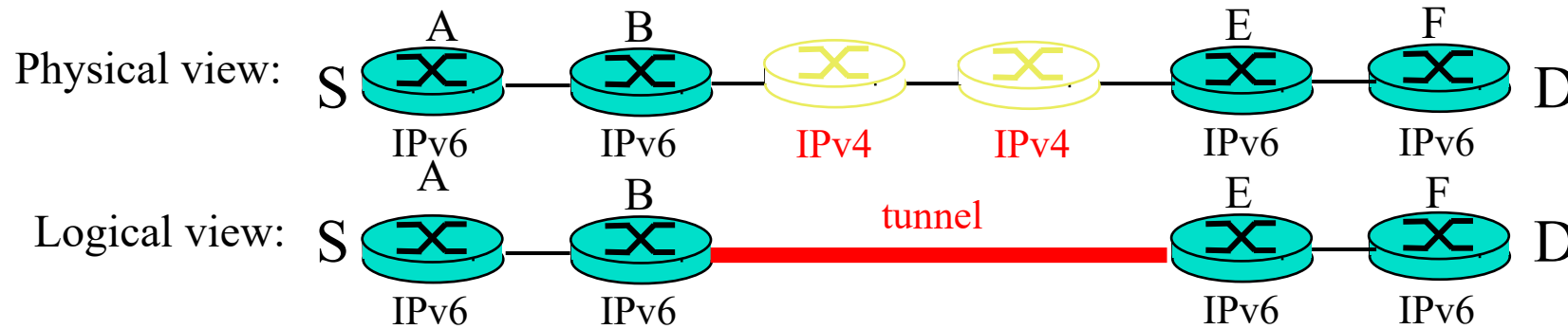

## Student Questions

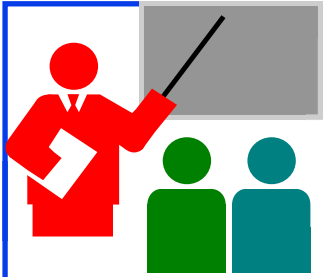

## Forwarding Protocols: Review

1. IPv4 uses 32 bit addresses consisting of **subnet + host**
2. **Private addresses** can be reused  
⇒ Helped solve the address shortage to a great extent
3. **DHCP** is used to automatically allocate addresses to hosts
4. IPv6 uses **128 bit addresses**. Requires dual stack or **tunneling** to coexist with IPv4.

### Student Questions

Ref: Read Section 4.3 of the textbook. Try R17 through R29.

Washington University in St. Louis

<http://www.cse.wustl.edu/~jain/cse473-21/>

©2021 Raj Jain

# Generalized Forwarding and SDN

- ❑ Planes of Networking
- ❑ Data vs. Control Logic
- ❑ OpenFlow Protocol

## Student Questions

# Planes of Networking

- ❑ **Data Plane:** All activities involving as well as resulting from data packets sent by the end user, e.g.,
  - Forwarding
  - Fragmentation and reassembly
  - Replication for multicasting
- ❑ **Control Plane:** All activities that are necessary to perform data plane activities but do not involve end-user data packets
  - Making routing tables
  - Setting packet handling policies (e.g., security)
  - Base station beacons announcing availability of services

Ref: Open Data Center Alliance Usage Model: Software Defined Networking Rev 1.0,”

[http://www.opendatacenteralliance.org/docs/Software\\_Defined\\_Networking\\_Master\\_Usage\\_Model\\_Rev1.0.pdf](http://www.opendatacenteralliance.org/docs/Software_Defined_Networking_Master_Usage_Model_Rev1.0.pdf)

## Student Questions

# Planes of Networking (Cont)

- ❑ **Management Plane:** All activities related to provisioning and monitoring of the networks
  - Fault, Configuration, Accounting, Performance and Security (**FCAPS**).
  - Instantiate new devices and protocols (Turn devices on/off)
  - Optional ⇒ May be handled manually for small networks.
- ❑ **Services Plane:** Middlebox services to improve performance or security, e.g.,
  - Load Balancers, Proxy Service, Intrusion Detection, Firewalls, SSL Off-loaders
  - Optional ⇒ Not required for small networks

## Student Questions

# Data vs. Control Logic

- ❑ Data plane runs at line rate,  
e.g., 100 Gbps for 100 Gbps Ethernet  $\Rightarrow$  Fast Path  
 $\Rightarrow$  Typically implemented using special hardware,  
e.g., Ternary Content Addressable Memories (TCAMs)
- ❑ Some exceptional data plane activities are handled by the CPU  
in the switch  $\Rightarrow$  Slow path  
e.g., Broadcast, Unknown, and Multicast (BUM) traffic
- ❑ All control activities are generally handled by CPU

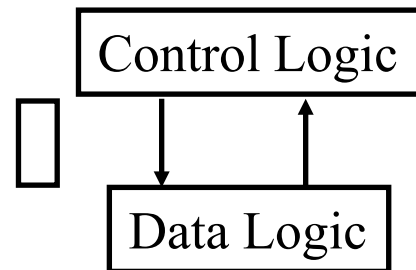

## Student Questions



# OpenFlow: Key Ideas

1. Separation of control and data planes
2. Centralization of control
3. Flow based control

## Student Questions

Ref: N. McKeown, et al., "OpenFlow: Enabling Innovation in Campus Networks," ACM SIGCOMM CCR, Vol. 38, No. 2, April 2008, pp. 69-74.

# Separation of Control and Data Plane

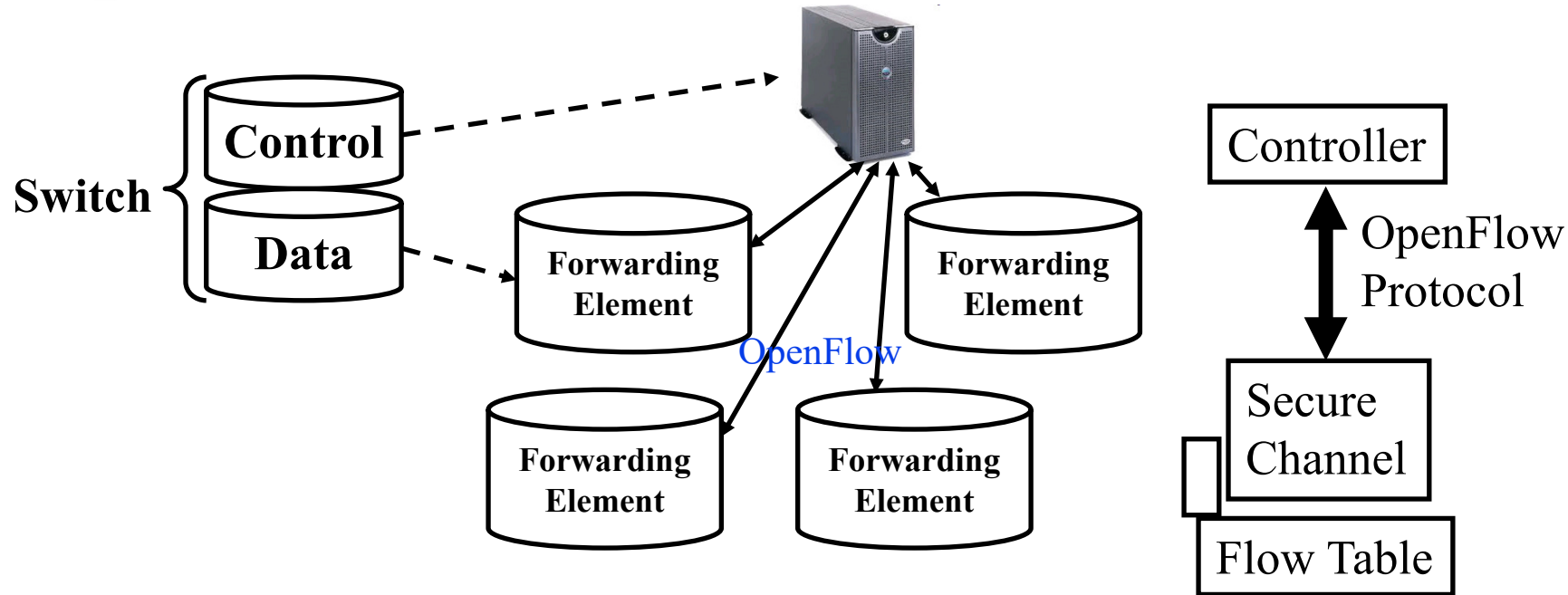

- ❑ Control logic is moved to a controller
- ❑ Switches only have forwarding elements
- ❑ One expensive controller with a lot of cheap switches
- ❑ OpenFlow is the protocol to send/receive forwarding rules from controller to switches

## Student Questions

# OpenFlow V1.0

- On packet arrival, match the header fields with flow entries in a table, if any entry matches, perform indicated actions, and update the counters indicated in that entry

Flow Table:

Header Fields	Actions	Counters
Header Fields	Actions	Counters
...	...	...
Header Fields	Actions	Counters

Ingress Port	Ether Source	Ether Dest	VLAN ID	VLAN Priority	IP Src	IP Dst	IP Proto	IP ToS	Src L4 Port	Dst L4 Port
--------------	--------------	------------	---------	---------------	--------	--------	----------	--------	-------------	-------------

## Student Questions

Ref: <http://archive.openflow.org/documents/openflow-spec-v1.0.0.pdf>

Washington University in St. Louis

<http://www.cse.wustl.edu/~jain/cse473-21/>

©2021 Raj Jain

# Flow Table Example

Port	Src MAC	Dst MAC	VLAN ID	Priority	EtherType	Src IP	Dst IP	IP Proto	IP ToS	Src L4 Port ICMP Type	Dst L4 Port ICMP Code	Action	Counter
*	*	0A:C8:*	*	*	*	*	*	*	*	*	*	Port 1	102
*	*	*	*	*	*	*	192.168.*.*	*	*	*	*	Port 2	202
*	*	*	*	*	*	*	*	*	*	21	21	Drop	420
*	*	*	*	*	*	*	*	0x806	*	*	*	Local	444
*	*	*	*	*	*	*	*	0x1*	*	*	*	Controller	1

- ❑ Idle timeout: Remove entry if no packets received for this time
- ❑ Hard timeout: Remove entry after this time
- ❑ If both are set, the entry is removed if either one expires.

Ref: S. Azodolmolky, "Software Defined Networking with OpenFlow," Packt Publishing, October 2013, 152 pp., ISBN:978-1-84969-872-6 (Safari Book)

## Student Questions

# Matching

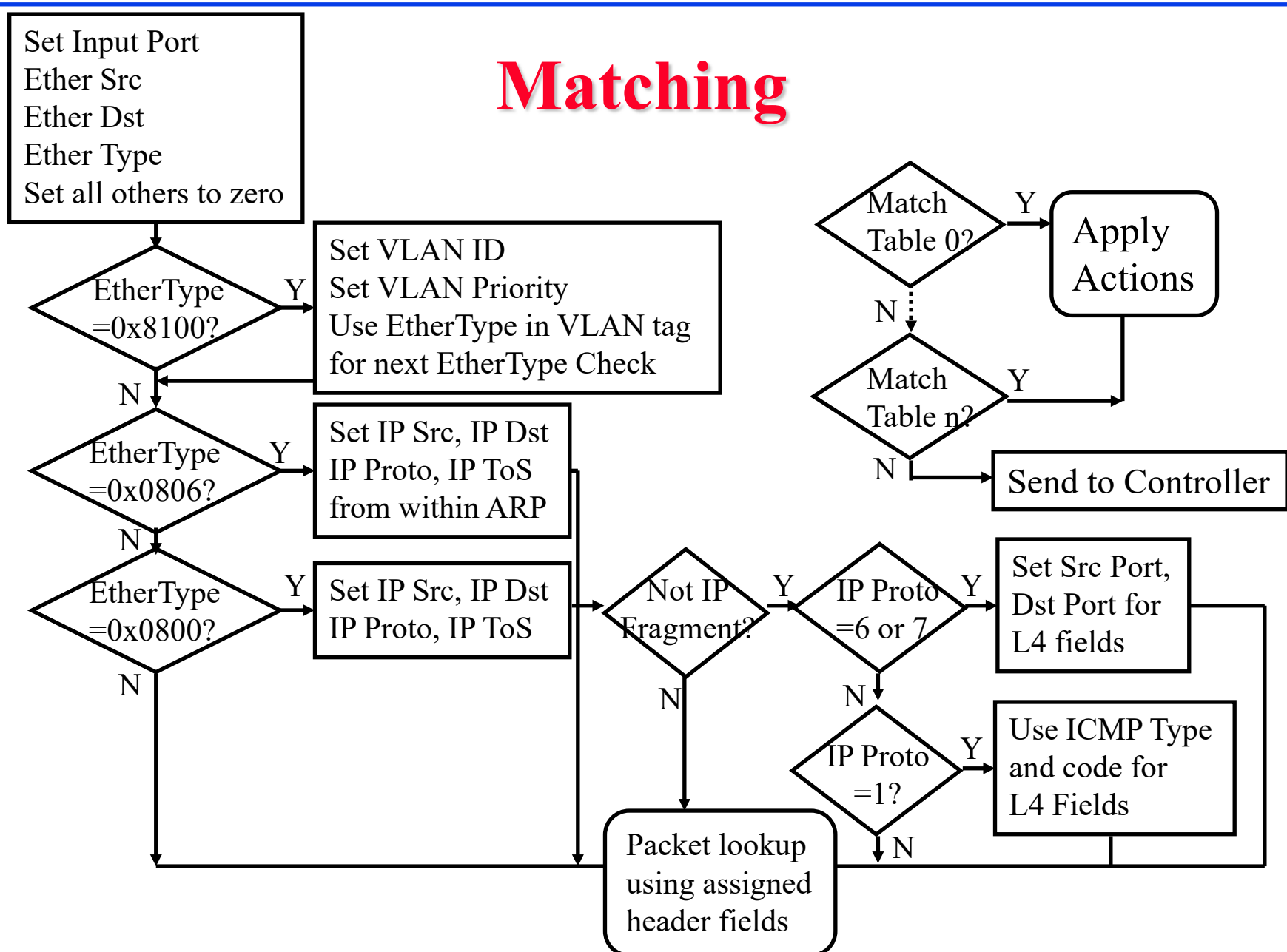

## Student Questions

# Counters

Per Table	Per Flow	Per Port	Per Queue
Active Entries	Received Packets	Received Packets	Transmit Packets
Packet Lookups	Received Bytes	Transmitted Packets	Transmit Bytes
Packet Matches	Duration (Secs)	Received Bytes	Transmit overrun errors
	Duration (nanosecs)	Transmitted Bytes	
		Receive Drops	
		Transmit Drops	
		Receive Errors	
		Transmit Errors	
		Receive Frame Alignment Errors	
		Receive Overrun errors	
		Receive CRC Errors	
		Collisions	

## Student Questions

# Actions

- ❑ Forward to Physical/**Virtual Port  $i$**
- ❑ Enqueue: To a particular **queue** in the port  $\Rightarrow$  QoS
- ❑ Drop
- ❑ Modify Field: E.g., add/remove VLAN tags, ToS bits, Change TTL
- ❑ Masking allows matching only selected fields, e.g., Dest. IP, Dest. MAC, etc.
- ❑ If header matches an entry, corresponding actions are performed and counters are updated
- ❑ If no header match, the packet is queued and the **header is sent to the controller**, which sends a new rule. Subsequent packets of the flow are handled by this rule.
- ❑ Secure Channel: Between controller and the switch using TLS

## Student Questions

## Actions (Cont)

- ❑ Modern switches already implement flow tables, typically using Ternary Content Addressable Memories (TCAMs)
- ❑ Controller can change the forwarding rules if a client moves  
⇒ Packets for mobile clients are forwarded correctly
- ❑ Controller can send flow table entries beforehand (**Proactive**) or Send on demand (**Reactive**). OpenFlow allows both models.

## Student Questions



# SDN Data Plane: Summary

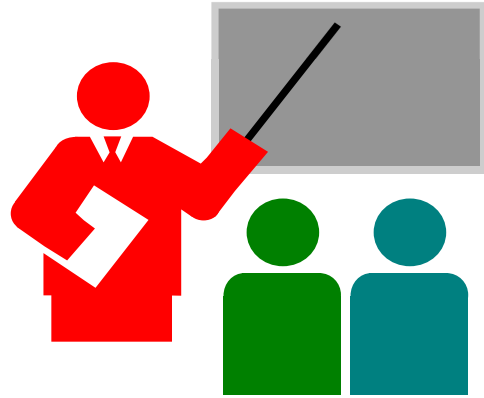

1. **Data plane** consists of packets sent by the users
2. OpenFlow separates data plane from the **control plane** and centralizes the control plane
3. The **controller** makes rules for forwarding and sends to switches
4. Switches match the rules and take specified actions

## Student Questions

# Network Layer Data Plane: Summary

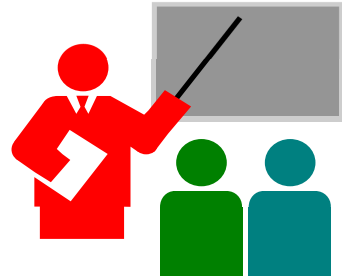

1. **Forwarding** consists of matching the destination address to a list of entries in a table. **Routing** consists of making that table.
2. IP is a forwarding protocol. IPv4 uses 32 bit addresses in **dot-decimal notation**. IPv6 uses 128 bit addresses in **Hex-Colon notation**.
3. **DHCP** is used to assign addresses dynamically.
4. **Private addresses** are used inside an enterprise network. **NAT** allows a single public address to be used by many internal hosts with private addresses.
5. **OpenFlow** separates data plane from control plane and centralizes the control plane

## Student Questions

# Acronyms

- ❑ ACK Acknowledgement
- ❑ ACM Automatic Computing Machinery
- ❑ AQM Active Queue Management
- ❑ ARP Address Resolution Protocol
- ❑ ATM Asynchronous Transfer Mode
- ❑ BGP Border Gateway Protocol
- ❑ BUM Broadcast, Unknown, and Multicast
- ❑ CAMs Content Addressable Memories
- ❑ CBR Constant bit rate
- ❑ CCR Computer Communications Review
- ❑ CIDR Classless Inter-Domain Routing
- ❑ CPU Central Processing Unit
- ❑ DHCP Dynamic Host Control Protocol
- ❑ DNS Domain Name Service
- ❑ FCAPS Fault, Configuration, Accounting, Performance and Security
- ❑ FCFS First Come First Served

## Student Questions

# Acronyms (Cont)

- ❑ FTP File Transfer Protocol
- ❑ GFR Guaranteed Frame Rate
- ❑ HTTP Hyper-Text Transfer Protocol
- ❑ ICMP IP Control Message Protocol
- ❑ ID Identifier
- ❑ IP Inter-Network Protocol
- ❑ IPv4 IP Version 4
- ❑ IPv6 IP Version 6
- ❑ ISP Internet Service Provider
- ❑ KISS Keep it simple stupid
- ❑ LAN Local Area Network
- ❑ MAC Media Access Control
- ❑ MS Microsoft
- ❑ MTU Maximum Transmission Unit
- ❑ NAT Network Address Translation
- ❑ PBX Private Branch Exchange

## Student Questions

# Acronyms (Cont)

- ❑ PHY Physical Layer
- ❑ QoS Quality of Service
- ❑ RED Random Early Drop
- ❑ RFC Request for Comment
- ❑ RIP Routing Information Protocol
- ❑ RTT Round Trip Time
- ❑ SDN Software Defined Networking
- ❑ SMTP Simple Mail Transfer Protocol
- ❑ SSL Secure Socket Layer
- ❑ TCAM Ternary Content Addressable Memory
- ❑ TCP Transmission Control Protocol
- ❑ TLS Transport Level Security
- ❑ ToS Type of Service
- ❑ TTL Time to live
- ❑ UBR Unspecified bit rate
- ❑ UPnP Universal Plug and Play

## Student Questions

# Acronyms (Cont)

- ❑ VBR Variable bit rate
- ❑ VCI Virtual Circuit Identifiers
- ❑ VLAN Virtual Local Area Network
- ❑ VPN Virtual Private Network
- ❑ WAN Wide Area Network
- ❑ WiFi Wireless Fidelity

## Student Questions

**Scan This to Download These Slides**



Raj Jain

<http://rajjain.com>

[http://www.cse.wustl.edu/~jain/cse473-21/i\\_4nld.htm](http://www.cse.wustl.edu/~jain/cse473-21/i_4nld.htm)

**Student Questions**

# Related Modules



CSE 567: The Art of Computer Systems Performance Analysis  
[https://www.youtube.com/playlist?list=PLjGG94etKypJEKjNAa1n\\_1X0bWWNyZcof](https://www.youtube.com/playlist?list=PLjGG94etKypJEKjNAa1n_1X0bWWNyZcof)

CSE473S: Introduction to Computer Networks (Fall 2011),  
[https://www.youtube.com/playlist?list=PLjGG94etKypJWOSPMh8Azcg5e\\_10TiDw](https://www.youtube.com/playlist?list=PLjGG94etKypJWOSPMh8Azcg5e_10TiDw)



CSE 570: Recent Advances in Networking (Spring 2013)  
<https://www.youtube.com/playlist?list=PLjGG94etKypLHyBN8mOgwJLHD2FFIMGq5>

CSE571S: Network Security (Spring 2011),  
<https://www.youtube.com/playlist?list=PLjGG94etKypKvzfVtutHcPFJXumyyg93u>



Video Podcasts of Prof. Raj Jain's Lectures,  
<https://www.youtube.com/channel/UCN4-5wzNP9-ruOzQMs-8NUw>

## Student Questions